

zerouno

2021 —  
COLLECTION

Frigerio

\_01

Un nuovo percorso creativo si concretizza in Frigerio, storica realtà italiana che oggi grazie alla guida della seconda e terza generazione si distingue proprio per la grande dinamicità e una visione aperta all'innovazione. Il mondo Frigerio, conosciuto e apprezzato per la varietà di proposte e soluzioni d'arredo, oltre che per la qualità di materiali e delle lavorazioni, esprime perfettamente la cura dei dettagli e il valore di ogni prodotto firmato dall'azienda. Dietro alla costante attività di ricerca e sviluppo delle collezioni che anno dopo anno rinnovano e ampliano l'offerta, il design che caratterizza la nuova collezione Frigerio è sobrio e senza tempo, incontra diversi gusti e si inserisce facilmente in ogni ambito progettuale. Prodotti in grado di dialogare con l'ambiente circostante, per contrasto o per affinità, ma sempre all'insegna di una coerenza formale: universi in armonia con la nuova anima dell'azienda, i cui prodotti ne rappresentano emanazioni ed estensioni visibili.

A new creative path takes shape in Frigerio, a historical Italian reality, which today, thanks to the leadership of the second and third generation, stands out for its great dynamism and vision open to innovation. The world of Frigerio, known and appreciated for the variety of the proposals and furnishing solutions, in addition to the quality of the materials and manufacturing, perfectly expresses the attention to details and the value of every single product made by the company. Behind the constant activity of research and development of the collections, which year after year renew and expand the offer, the design which characterized the new collection is sober and timeless, it meets different tastes and it fits easily in every planning context. Products capable of dialoguing with the surrounding environment, by contrast or affinity, but always under a formal coherence: universes in harmony with the new soul of the company, whose products represent the visible emanations and extensions.

# Frigerio



2021 COLLECTION  
LOCATION

Inserito dalla Getty Foundation fra i capolavori di architettura del XX secolo, Torino Esposizioni è stato scelto come scenografia ideale - e non convenzionale - per ambientare la nuova collezione Frigerio. Progettato da Ettore Sottsass senior nel 1938 con la collaborazione di Pier Luigi Nervi, l'edificio si caratterizza per l'ampia volta a padiglione, sostenuta da quattro arcate in cemento ondulato. Inondata di luce, la volta del grande salone crea un elegante gioco di geometrie, che illuminano ed esaltano la qualità e il design dei prodotti Frigerio, volutamente rappresentati in un contesto fuori scala.

Listed by the Getty Foundation as one of the masterpieces of 20th century architecture, Torino Esposizioni has been selected as ideal - yet unconventional - setting for the new Frigerio Collection. Designed by Ettore Sottsass senior in 1938 with the collaboration of Pier Luigi Nervi, the building features a large pavilion vault, supported by four arches in wavy-shaped concrete. Flooded with light, the vaulted ceiling of the great hall creates an elegant play of geometries, which illuminates and enhances the quality and the design of the Frigerio products, intentionally represented in an out-of-scale context.



Frigerio svela una nuova identità progettuale arricchendo la collezione di inedite proposte, frutto di nuove collaborazioni che marciano una netta discontinuità con le precedenti collezioni. A tracciare questo nuovo percorso sono le proposte di Christophe Pillet e Federica Biasi, che affiancano nomi già vicini al mondo Frigerio, come Umberto Asnago, che ha firmato già diversi progetti e Gianfranco Frigerio. Il nuovo filo conduttore per il racconto delle novità è un invito alla luce e alla leggerezza. Un concetto che rende proprio quell'idea di vita quotidiana, fresca, giovane, dinamica alla base della nuova identità di Frigerio. Una leggerezza capace di dare sempre la giusta importanza senza il peso dell'eccesso, in tal senso l'ispirazione alla citazione di Italo Calvino tratta da Lezioni americane, 1988: "Prendete la vita con leggerezza che leggerezza non è superficialità ma planare sulle cose dall'alto non avere macigni sul cuore. [...] La leggerezza per me si associa con la precisione e la determinazione, non con la vaghezza e l'abbandono al caso".

Frigerio unveils a new design identity enriching the collection with new proposals, results of new collaborations which mark a clear discontinuity with the previous collections. Outlining this new path there are the proposals designed by Christophe Pillet and Federica Biasi, who join names already close to the Frigerio world, such as Umberto Asnago, who has already designed several projects, and Gianfranco Frigerio. The new fil rouge telling the novelties is an invitation to light and lightness. A concept that renders precisely the idea of daily life, fresh, young and dynamic at the basis of the new Frigerio identity. A lightness capable to give always the right importance without the weight of the excess, in such sense the inspiration comes from the quote by Italo Calvino, taken from *Lezioni Americane*, 1988: "Take life with lightness, as lightness is not superficiality but gliding over things from up above, not having boulders on your heart [...] Lightness, for me, is associated to precision and determination, not to vagueness and abandonment to chance."

CHRISTOPHE PILLET



FEDERICA BIASI

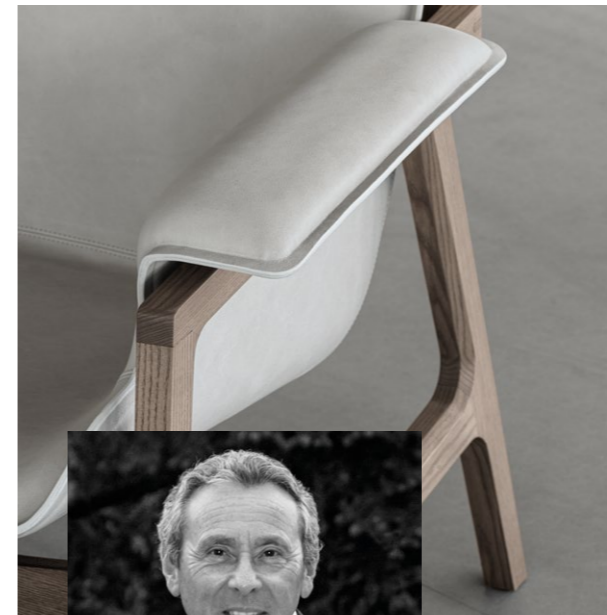

UMBERTO ASNAGO



GIANFRANCO FRIGERIO



HORIZON SOFA  
CHRISTOPHE PILLET

10



ARNÈ SOFA  
GIANFRANCO FRIGERIO

66

INDEX



SANTAMONICA SMALL TABLE  
CHRISTOPHE PILLET

22



AXEL TABLE  
UMBERTO ASNAGO

38



HULI ARMCHAIR  
FEDERICA BIASI

32



ARIANNA ARMCHAIR  
UMBERTO ASNAGO

50

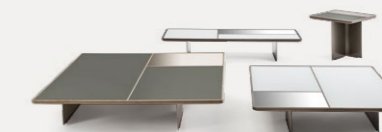

MIES SMALL TABLE  
UMBERTO ASNAGO

54



ANALOG BOOKCASE / SIDEBOARD  
CHRISTOPHE PILLET

26



AMANDA ARMCHAIR  
UMBERTO ASNAGO

46



AMANDA CHAIR  
UMBERTO ASNAGO

42



JONAS POUF  
GIANFRANCO FRIGERIO

72



ALFRED BED & BENCH + LIV NIGHT TABLE  
UMBERTO ASNAGO

58

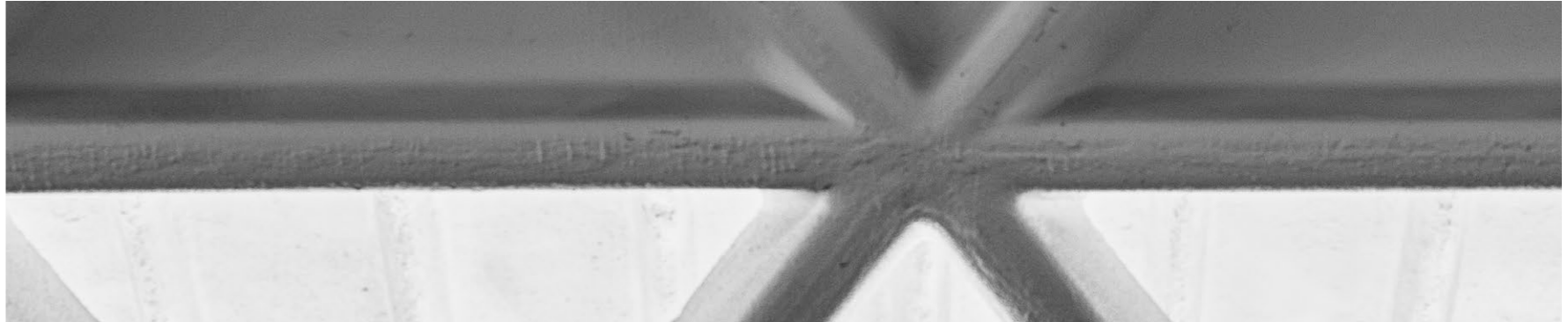

HORIZON  
SANTAMONICA  
ANALOG

DESIGN BY

CHRISTOPHE PILLET

Architettura, oggetti, mobili,  
direzione artistica: la firma di  
Christophe Pilet è immanca-  
bilmente associata ai migliori  
marchi e progetti di prestigio. Dopo il Master  
alla Domus Academy a Milano e importanti  
collaborazioni apre il suo studio nel 1993. Per  
Frigerio inizia a disegnare nel 2021, presentan-  
do un'ampia collezione.

Architecture, objects, furniture, art direction:  
Christophe Pilet's signature is unfailingly  
associated with the best brands and prestigious  
projects. After a Master's degree at the Domus  
Academy in Milan and important collaborations,  
he opened his own studio in 1993. He began  
designing for Frigerio in 2021, presenting a wide  
collection.





2021 COLLECTION **HORIZON** DESIGN BY CHRISTOPHE PILLET

## HORIZON

SOFA

HORIZON, è un divano modulare su pianale che interpreta con il tratto disinvolto di Pillet la qualità e la cura di Frigerio. Una proposta che riflette l'abitare contemporaneo e il ruolo che oggi è richiesto al divano: elemento protagonista dello spazio sempre più versatile e fluido nell'uso e nelle funzioni.

HORIZON, is a modular sofa on platform that interprets the quality and care of Frigerio with Pillet's nonchalant style. A proposal that reflects the contemporary living and the role which is today required of the sofa: leading element of the space, which is increasingly versatile and fluid in its use and functions.









Della collezione HORIZON fanno parte anche eleganti elementi contenitivi a cassetto, in legno di frassino o noce canaletto, per accogliere gli oggetti del living.

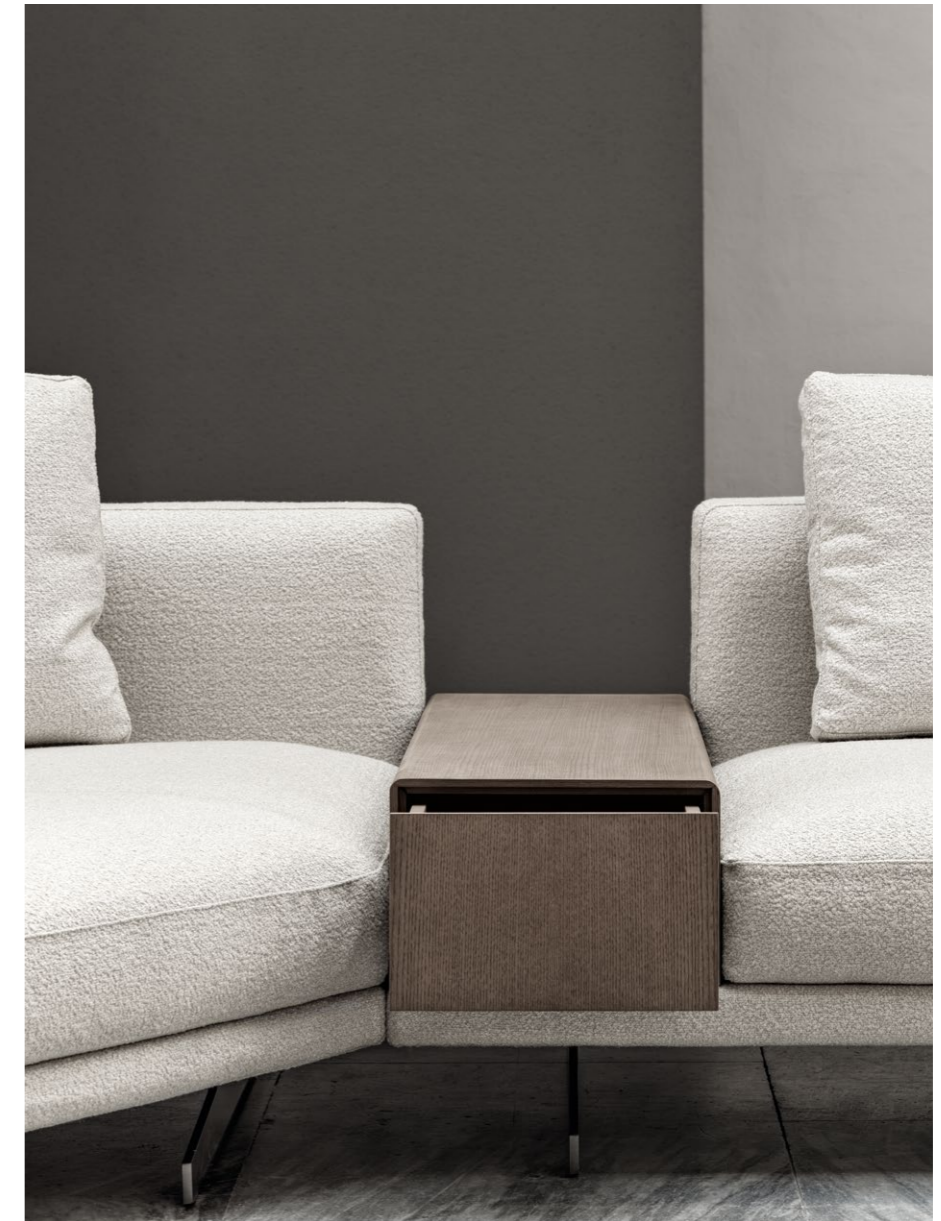

The HORIZON collection also includes elegant drawer units made of ash or walnut Canaletto for storing objects of our daily living.





2021 COLLECTION **HORIZON** DESIGN BY CHRISTOPHE PILLET

The valet stand with marble top is an accessory that, combined with the soft part of the sofa, makes HORIZON a real furnishing element with a sophisticated design.

Il servomuto con top in marmo è un complemento che, accostato nell'incontro con la parte morbida del divano, rende HORIZON un vero e proprio elemento d'arredo dal design sofisticato.





## SANTAMONICA

SMALL TABLE

Famiglia di tavolini di differenti dimensioni ed altezze per soluzioni flessibili alle diverse necessità d'arredo, sono un prodotto elegante nella loro apparente semplicità. Soli o in set, si inseriscono con innata leggerezza e disinvoltura in ogni ambito progettuale.



A family of coffee tables available in different sizes and heights for flexible solutions according to different furnishing needs, they are an elegant product in its apparent simplicity. On their own or as a set, they fit with natural lightness and ease into any design context.







2021 COLLECTION **ANALOG** DESIGN BY CHRISTOPHE PILLET

## ANALOG

BOOKCASE

Contenitore a giorno di forma trapezoidale, alto e basso, si distingue per la lavorazione sartoriale sia dei bordi smussati della struttura in legno di frassino o noce canaletto, che dei piani. Interpretazioni contemporanee dell'abitare che svelano l'estrema cura del dettaglio di Frigerio.

Trapezoidal open storage unit, tall and low, standing out for the tailoring of both the bevelled edges of the ash or walnut Canaletto structure and shelves. Contemporary interpretations of living that reveal Frigerio's extreme care to detail.









DESIGN BY

HULI | FEDERICA BIASI

Born in 1989, Federica Biasi founded her studio in Milan in 2015, after some professional experiences in Italy and in the Netherlands. Her always clean aesthetic approach is characterised by the search for simple and soft shapes. In 2021 she signed her first project for

Classe 1989, Federica Biasi fonda il suo studio a Milano nel 2015, dopo alcune esperienze professionali in Italia e nei Paesi Bassi. Il suo approccio estetico sempre pulito si caratterizza per la ricerca di forme semplici e morbide. Nel 2021 firma il suo primo progetto per Frigerio, con cui condivide la passione per la qualità e il dettaglio.

Frigerio, with whom she shares the passion for quality and detail.

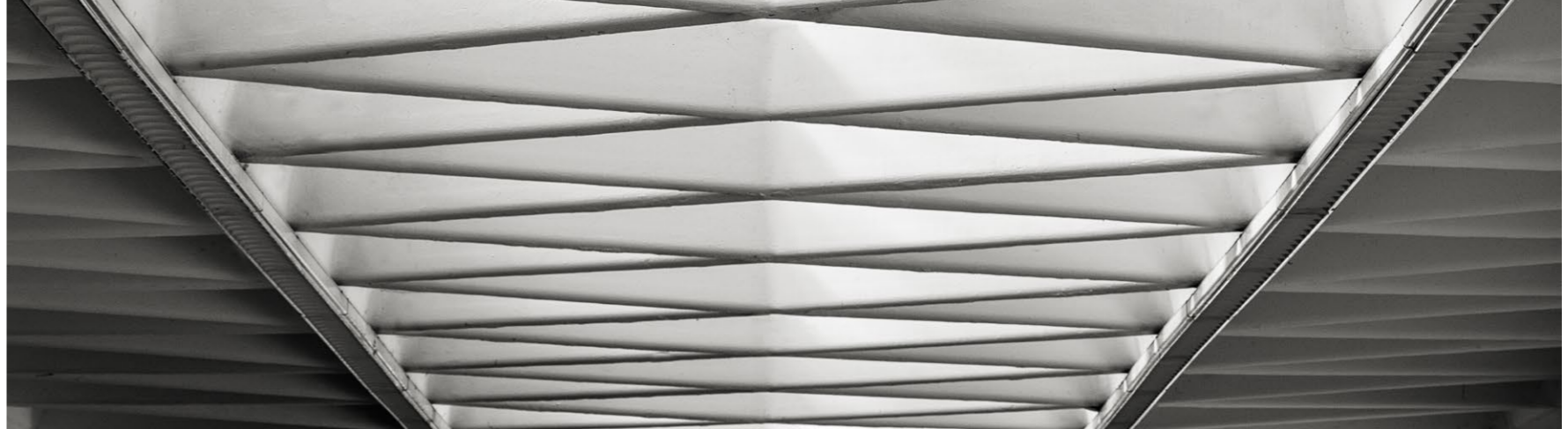



## HULI ARMCHAIR

Delicata e leggera nel suo carattere ispirato agli stili del design nordico, HULI si caratterizza per il gioco di linee morbide. Una lavorazione tradizionale per un prodotto dal gusto marcatamente contemporaneo, nei volumi e nella scelta dei materiali.

Delicate and light in its character inspired by Nordic design styles, HULI features a play of soft lines. A traditional workmanship for a product with a strong contemporary taste, in its volumes and choice of materials.



Seat and backrest are distinguished  
by the peculiar rope weave, which gives  
an artisan touch to the living area.



Seduta e schienale si distinguono per il particolare  
intreccio in corda, che dona un tocco artigianale  
alla zona living.



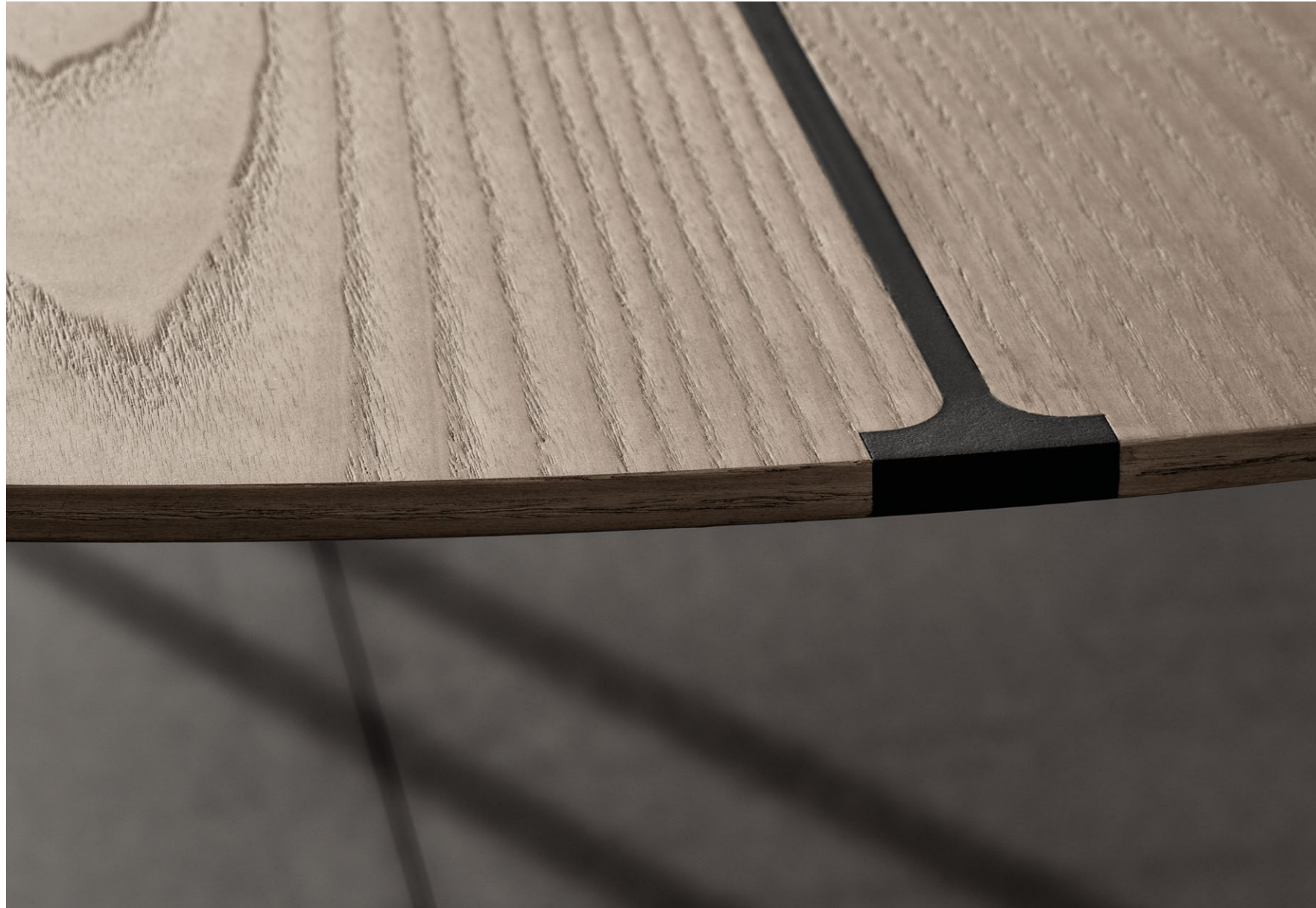

AXEL  
AMANDA  
ARIANNA  
MIES  
ALFRED  
LIV

DESIGN BY

UMBERTO ASNAGO

Umberto Asnago è un designer che con grande professionalità interpreta le rapide evoluzioni del settore del mobile. Dal 2019 inizia la sua collaborazione con Frigerio, firmando una vasta gamma di elementi d'arredo caratterizzati dall'uso sapiente di legno massello e rivestimenti in cuoio.

Umberto Asnago is a designer who interprets with great professionalism the rapid evolution of the furniture sector. In 2019 he began his collaboration with Frigerio, designing a wide range of furniture elements characterised by the skilful use of solid wood and leather covers.





**AXEL**  
TABLE

Pensato per la zona dining, il tavolo AXEL si distingue per le gambe scultoree finemente lavorate, che sostengono il piano in legno, in cui un intarsio nero a filo a verticale divide in due metà il tavolo. Un tocco elegante che enfatizza la venatura del legno valorizzandola.

Conceived for the dining area, the AXEL table is distinguished by its finely manufactured sculptural legs, which support the wooden top, in which a black flush vertical inlay divides the table into two halves. An elegant touch that emphasises the wood grain and enhances it.





## AMANDA

CHAIR

Con o senza braccioli, la sedia AMANDA si caratterizza per la sua estrema versatilità ed eleganza senza tempo.

Ricerca nelle accoglienti proporzioni tra seduta e schienale, il basamento in legno è proposto in cinque tinte di frassino o noce canaletto, con rivestimento in pelle o tessuto.



With or without armrests, the AMANDA chair is characterised by its extreme versatility and timeless elegance. Refined in its welcoming proportions between seat and backrest, the wooden base is available in five shades of ash or walnut Canaletto, covered in leather or fabric.









Contemporary design with a vintage spirit, the enveloping  
suspended armrest springs directly from the backrest to ensure  
the right balance between aesthetics and maximum comfort.

Design contemporaneo dallo spirito vintage, il bracciolo  
avvolgente sospeso nasce direttamente dallo schienale,  
per assicurare il giusto equilibrio tra estetica e massimo comfort.



2021 COLLECTION **AMANDA** ARMCHAIR / BERGÈRE DESIGN BY UMBERTO ASNAGO





Visually, the ARIANNA armchair combines lightness  
with the robustness of solid wood.  
The armrests open like wings and the body rests  
delicately on the structure, as if it were floating.  
Frigerio's tailoring workmanship is revealed  
in the details of the refined tone-on-tone stitching.

## ARIANNA

ARMCHAIR

Visivamente la poltrona ARIANNA unisce  
la leggerezza alla solidità del legno massello.  
I braccioli si aprono come ali e la scocca  
si posa delicatamente sulla struttura  
come se galleggiasse.

La lavorazione sartoriale di Frigerio si rivela nei  
dettagli delle raffinate cuciture tono su tono.

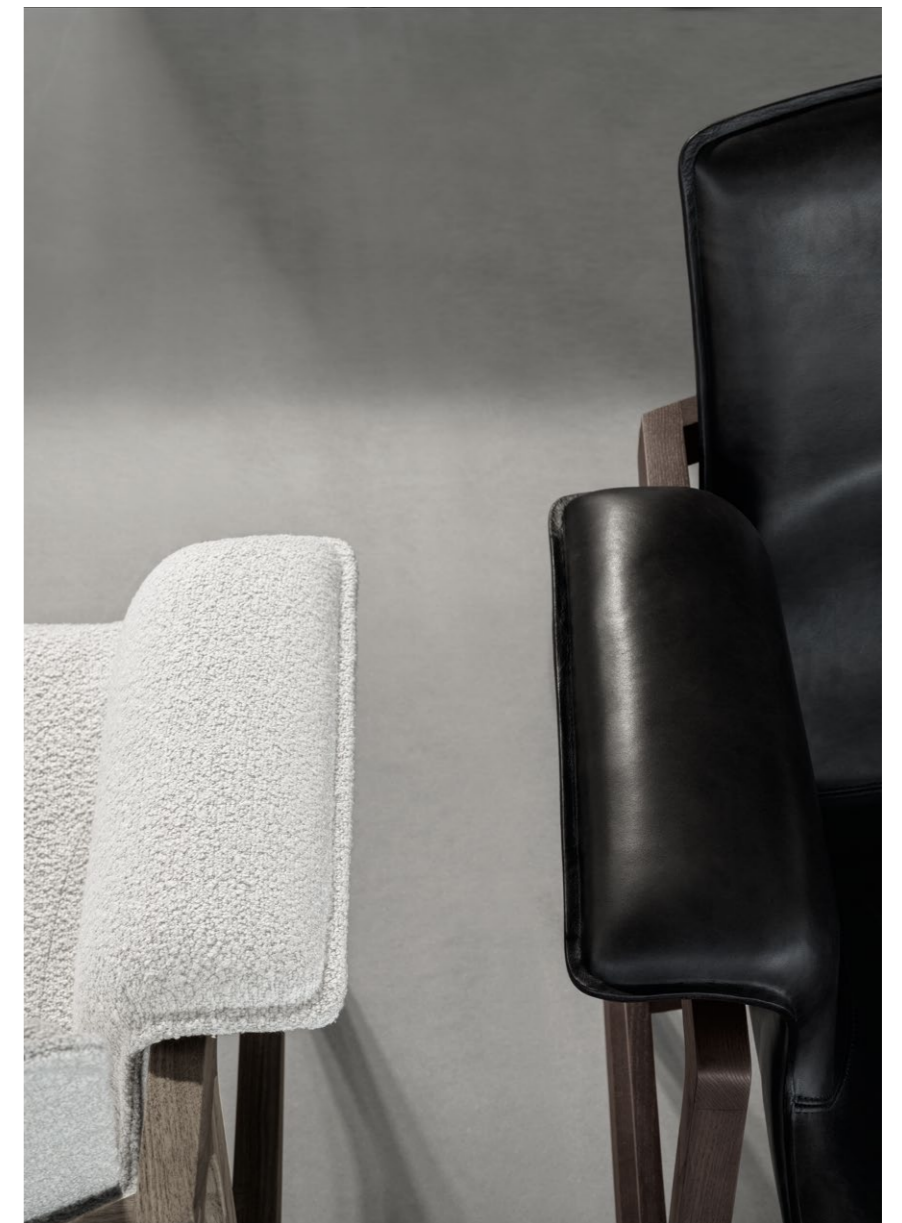



## MIES

SMALL TABLE

I tavolini MIES nascono dall'idea di creare due mondi differenti, in cui alle diverse essenze di legno è abbinato un vetro e uno specchio della stessa tonalità, o chiaro o scuro.

Un ricercato e mutevole gioco visivo di colori e materiali, che cambia a seconda del punto di vista da cui si osserva.



The MIES small tables are conceived on the idea of creating two different worlds, in which different finishes of wood are combined with glass and mirror in the same shade, either light or dark. A refined and changing visual play of colours and materials, which changes according to the point of view, from which it is observed.





## ALFRED

BED + BENCH

Rifugio personale, il letto ALFRED si distingue per la caratteristica testiera in pelle che avvolge delicatamente la struttura imbottita: due ali dal tratto elegante e deciso.

Le sartoriali finiture che delineano la silhouette del letto lo rendono un prodotto sofisticato che insieme all'omonima panca completa la zona notte.



A personal refuge, the ALFRED bed is distinguished by the characteristic leather headboard that delicately envelops the padded frame: two wings with an elegant and strong trait. The tailored finishes that outline the bed's silhouette make it a sophisticated product which, together with the bench of the same name, completes the sleeping area.









2021 COLLECTION **LIV** DESIGN BY UMBERTO ASNAGO

## LIV NIGHT TABLE

Il comodino LIV, con o senza cassetto, si inserisce con discrezione nella zona notte.

La forma irregolare del top sfugge dalla classica forma rettangolare per un accostamento elegante fra la base in metallo e il piano, impreziosito da elementi in legno massello e cuoio o pelle.

The LIV night table, with or without drawer, fits discreetly into the sleeping area. The irregular shape of the top escapes the classic rectangular form for an elegant combination between the metal base and top, enriched by solid wood elements and leather or hide.





ARNÉ  
JONAS

DESIGN BY

GIANFRANCO FRIGERIO

Direttore artistico dell'azienda, Gianfranco Frigerio ha disegnato gran parte della collezione attuale. Cresciuto

avvolto in un ambiente dove artigianalità e design sono una routine quotidiana, la sua profonda conoscenza del settore e la grande attenzione per la qualità dei materiali si riflettono nella sua nuova collezione per la zona living.

Artistic Director of the company, Gianfranco Frigerio has designed much of the current collection. Growing up surrounded by an environment where craftsmanship and design are a daily routine, his in-depth knowledge of the branch and his great attention to the quality of materials are reflected in his new collection for the living area.



## ARNÉ

SOFA

Divano modulare a terra fortemente caratterizzato da inaspettati elementi centrali dalle forme trapezoidali o ad angolo aperto, ARNÉ si definisce nell'anima sistemica e nella sua elevata versatilità compositiva. Rivestito in pelle o tessuto, la sua caratteristica visiva è il fondopiega.



A modular sofa with base at floor level, which is strongly characterised by unexpected central elements in trapezoidal or open-corner shapes, ARNÉ is defined by its systemic soul and its high compositional versatility. Covered in leather or fabric, its visual feature is the pleat at the bottom of the armrest.







La collezione si completa con una famiglia di mensole e tavolini che, utilizzati in diverse configurazioni, creano composizioni multifunzione sempre diverse.



The collection is completed by a family of shelves and small tables which, used in different configurations, create ever-changing multifunctional compositions.



Elegant square shaped stool featuring a hand-made leather twine. Available in two sizes, JONAS is a complement with an essential character capable of showing its full versatility adapting to both the day and night areas, in every kind of house, either modern or classic.

## JONAS

POUF

Elegante pouf dalla forma quadrata caratterizzato dall'intreccio manuale in pelle. Disponibile in due misure, JONAS è un complemento dal carattere essenziale capace di mostrare tutta la sua versatilità adattandosi sia alla zona giorno sia alla zona notte, in ogni tipologia di casa, moderna o classica.



**HORIZON SOFA** pag. 10

Christophe Pillet



Collezione di divani componibili su pianale con due profondità, rivestito in tessuto o pelle. Piedini in metallo verniciato. Cuscini schienale e bracciolo fissati al pianale con fissaggio a baionetta. Completano la gamma volumi con cassetto in legno ed imbottiti. Disponibili elementi server con fissaggio al pianale.

Collection of modular sofa on platform in two depths, covered in fabric or leather. Feet in metal painted. Back and armrest cushions are fixed to the platform with a bayonet mounting. The collection includes volumes with drawer in wood and padded elements. Server elements are available fixed to the platform.

COMPOSITION 01 pag. 16

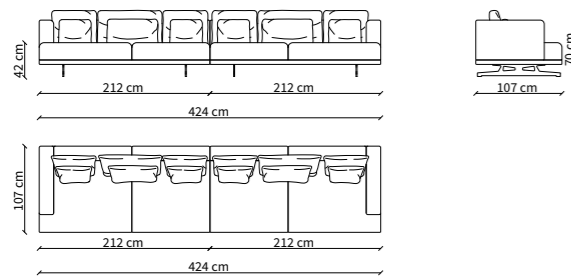

COMPOSITION 02 pag. 14

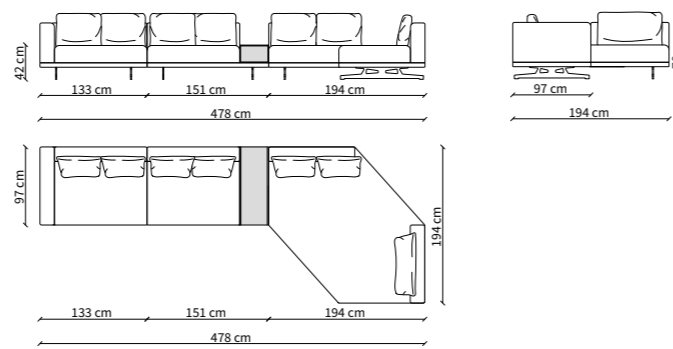

COMPOSITION 03 pag. 12

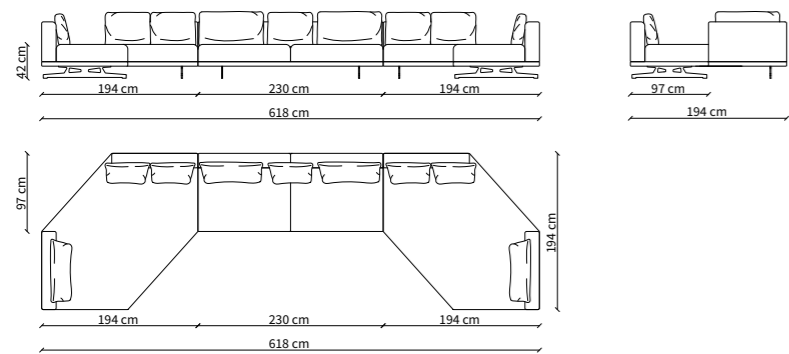

COMPOSITION 04 pag. 20

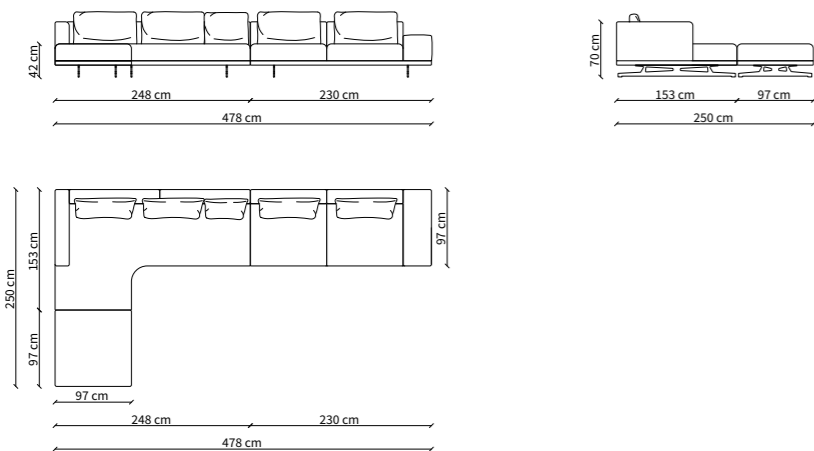

**ARNÈ SOFA** pag. 66

Gianfranco Frigerio



Collezione di divani ed elementi modulari disponibili in tessuto o pelle in un'unica profondità. Divano caratterizzato da fondopiega sul bracciolo. Piedini neri. La collezione include una gamma di accessori fra cui una consolle coordinata.

Collection of sofas and modular elements available in fabric or leather in one depth. Sofa featuring a pleat at the bottom of the armrest. Black feet. The collection includes a wide range of accessories between which a coordinated console.

COMPOSITION 01 pag. 71

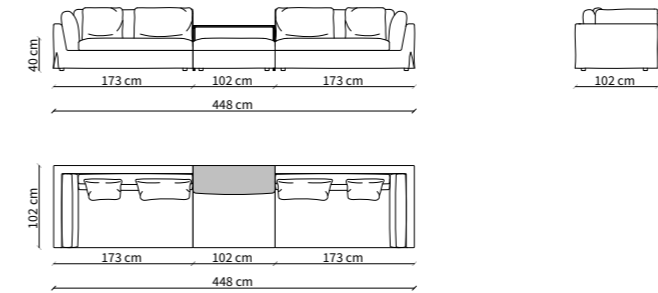

COMPOSITION 02 pag. 67

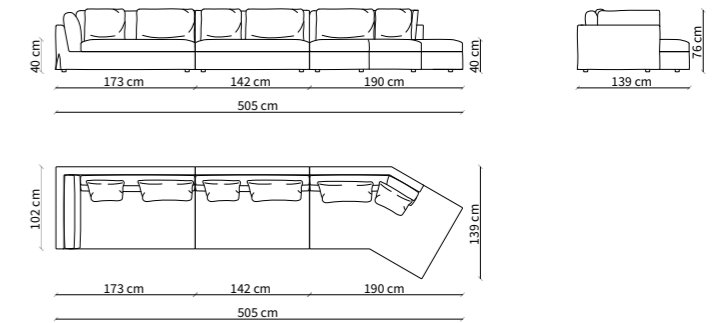

COMPOSITION 03 pag. 68

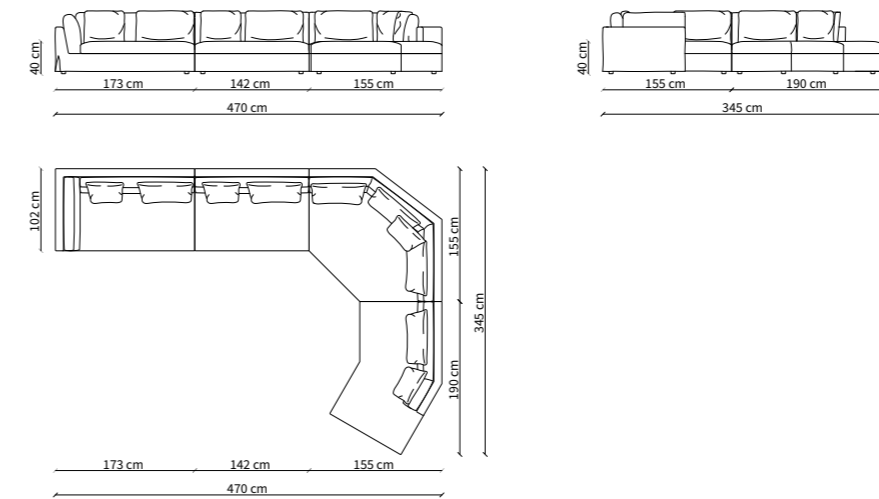

SERVER



CASSETTO



RETRODIVANO



POGGIATESTA



## HULI ARMCHAIR pag. 32

Federica Biasi



Lounge chair con struttura in legno massello e intreccio in corda. Materassina di bellezza rivestita in tessuto o pelle.

Lounge chair with solid wood structure and ropetwine. Beauty cushion covered in fabric or leather.

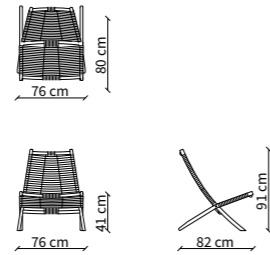

## AMANDA ARMCHAIR pag. 46

Umberto Asnago



Poltrona disponibile anche nella versione bergere rivestita in tessuto o pelle o nella versione con schienale rivestito esternamente in pelle ed internamente in tessuto. Basamento in noce canaletto o frassino nei colori Frigerio. Completa la collezione un pouf coordinato.

Armchair available also in the bergere version covered in fabric or leather or in the version with back externally covered in leather and internally in fabric. Base in solid wood walnut canaletto or ashwood in the Frigerio colours. Collection completed with a coordinated stool.

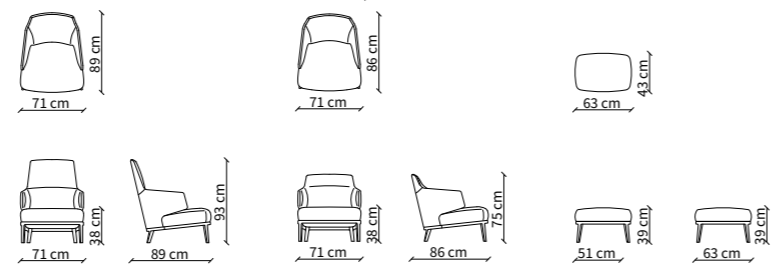

## AMANDA CHAIR pag. 42

Umberto Asnago



Sedia, con o senza braccioli, con basamento in legno in noce canaletto o frassino nei colori Frigerio. Seduta rivestita in tessuto o pelle o nella versione con schienale rivestito esternamente in pelle ed internamente in tessuto.

Chair with or without armrests with base in solid wood walnut canaletto or ashwood in the Frigerio colours. Seat covered in fabric or leather or in the version with back externally covered in leather and internally in fabric.

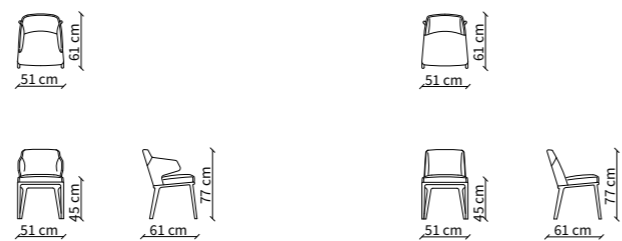

## ARIANNA ARMCHAIR pag. 50

Umberto Asnago



Poltrona con struttura in massello noce canaletto o in frassino nei colori Frigerio. Scocca imbottita in poliuretano rivestita in tessuto o pelle.

Armchair with solid wood structure in walnut canaletto or ashwood in the Frigerio colours. Padded body in polyurethane covered in fabric or leather.

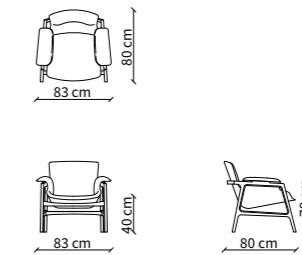

## AXEL TABLE pag. 38

Umberto Asnago



Collezione di tavoli da pranzo rettangolari con angoli smussati e tondi con basamento in legno massello in noce canaletto o frassino nei colori Frigerio. Top disponibile in legno con intarsio color nero o in vetro texturizzato nei colori della collezione con bordo in contrasto.

Collection of dining table rectangular with smoothed edges and round with base in solid wood in walnut canaletto or ashwood in the Frigerio colours. Top available in wood with black inlay or in texturized glass in the colours of the collection with perimeter in contrast.

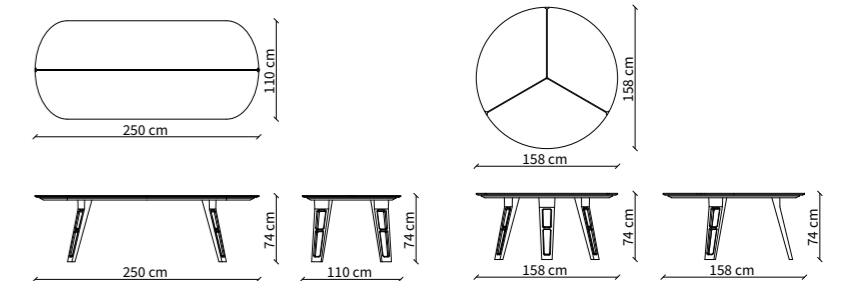

## MIES SMALL TABLE pag. 54

Umberto Asnago



Collezione di tavolini rettangolari e quadrati con top in noce canaletto o frassino nei colori Frigerio con inserti in vetro retroverniato e specchio in due varianti. Piedini in metallo verniciato.

Collection of small tables rectangular and squared with top in solid wood walnut canaletto or ashwood in the Frigerio colours with inserts with back-lacquered glass and mirror in two variants. Feet in painted metal.

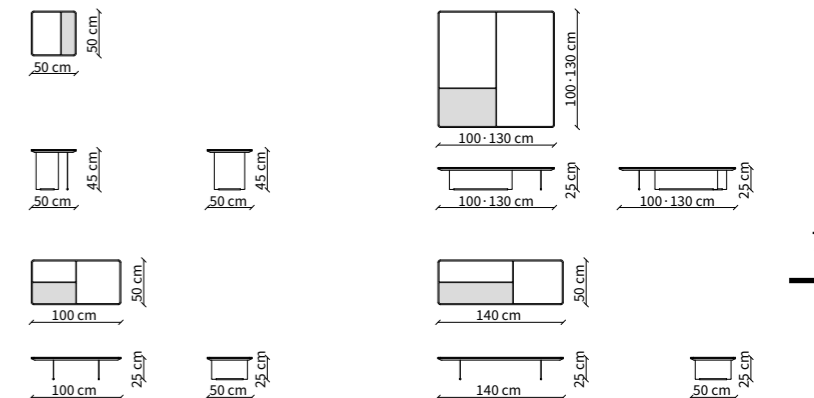



**SANTAMONICA SMALL TABLE pag. 22**

Christophe Pillet



Collezione di tavolini tondi con struttura in metallo verniciato con tre piedini tubulari e top in vetro texturizzato con bordo in contrasto o in legno canaletto o frassino nei colori Frigerio.

Collection of round small tables with structure in painted metal and three tubular feet and texturized glass top with perimeter in contrast or in wood canaletto or ashwood in the Frigerio colours.

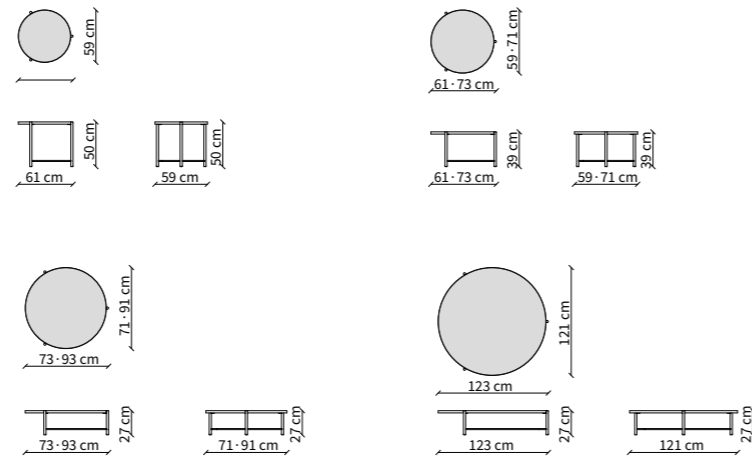

**ANALOG BOOKCASE / SIDEBORD pag. 26**

Christophe Pillet



Libreria e mobile basso a giorno con struttura impiallacciato legno noce canaletto o frassino nei colori Frigerio. Piedino in metallo verniciato. Schienale internamente rivestito in tessuto. Disponibile ripiano libero posizionamento in due dimensioni in vetro fumé.

Open bookcase and low sideboard with structured veneered walnut canaletto or ashwood in the Frigerio colours. Feet in painted metal. Back internally covered in fabric. Free standing shelf in two sizes available in fumé glass.

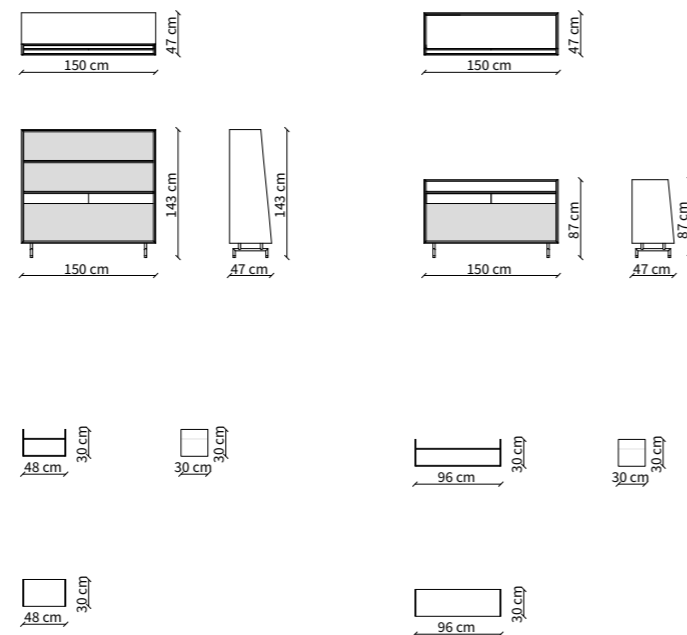

SHELF

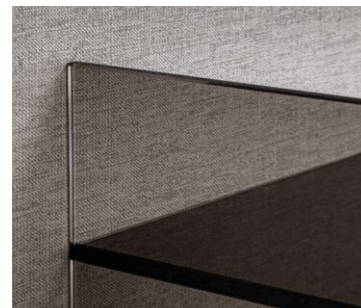

**ALFRED BED / BENCH pag. 58**

Umberto Asnago



Collezione di letti con doghe in legno con piedini rivestiti in pelle, basamento in legno massello e struttura imbottita rivestita in tessuto o pelle. Testata rivestita in tessuto o pelle o nella versione pelle esterna e tessuto interno. Completa la collezione la panca coordinata.

Collection of bed with wooden slatted bases with feet covered in leather, base in solid wood and padded structure covered in fabric or leather. Headboard covered in fabric or leather or in the mix version externally leather and internally fabric. Collection completed by a coordinated bench.

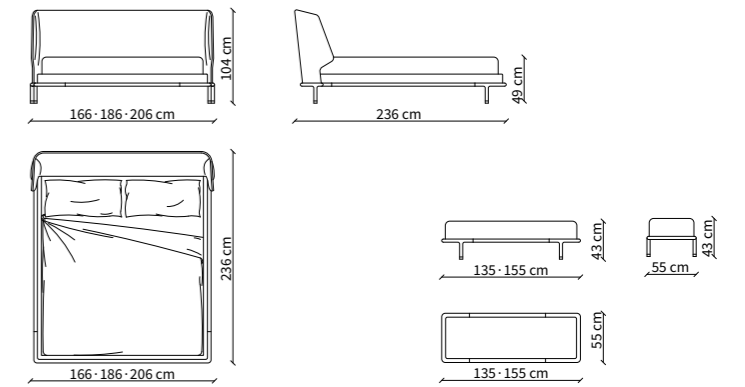

**LIV NIGHT TABLE / SMALL TABLE pag. 62**

Umberto Asnago



Comodino, con o senza cassetto, quest'ultimo in legno in noce canaletto o frassino nei colori Frigerio, con struttura in metallo verniciato. Top rivestito in cuoio o pelle con cornice in legno in noce canaletto o frassino nei colori Frigerio.

Night table, with or without drawer, the latter in walnut canaletto or ashwood in the Frigerio colours, with painted metal structure. Top covered in hide leather or leather with frame in wood walnut canaletto or ashwood in the Frigerio colours.

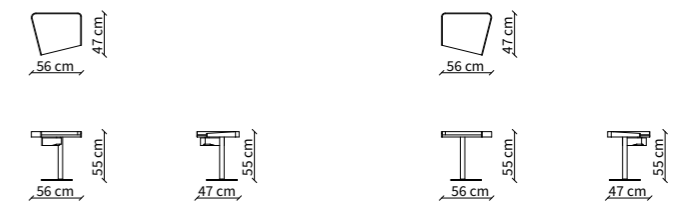

**JONAS POUF pag. 72**

Gianfranco Frigerio



Pouf con basamento in noce canaletto o frassino nei colori Frigerio. Struttura rivestita con pelle intrecciata con lavorazione completamente manuale.

Pouf with base in walnut canaletto or ashwood in the Frigerio colours. Structure covered with interlaced leather, hand-made manufactured.

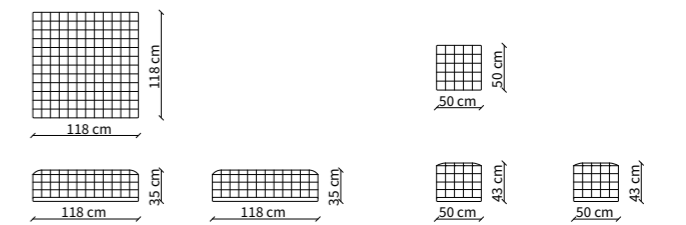

**Art Direction:**

R+W

**Graphic Project:**

Michela Boglietti

**Project Coordination:**

Riccardo Frigerio

**Photo:**

Location: Gionata Xerra Studio

Still-life: Studio Eleven

**Concept e styling:**

Euro Sironi

**Colour Separation :**

CD Cromo

**Photo Assistant location:**

Leonardo Duggento

Marco Manigrasso

**Postproduzione immagini location:**

Pierpaolo Mazzola

**Credits:**

Palazzo della Moda - Torino Esposizioni

Corso Massimo d'Azeglio 15

10126 - Torino

# Frigerio

FRIGERIO POLTRONE E DIVANI

Via Sant'Agata, 63

Mariano Comense CO - Italy

T. +39 031 5481225

[www.frigeriosalotti.it](http://www.frigeriosalotti.it)

