

D A Y



DESIGN ECO 

1920 **R** 2020  
MADE IN ITALY  
100<sup>th</sup>  
anniversary

## “PRODURRE PER TRAMANDARE”

*"Produrre con onestà per tramandare alle generazioni future, costruendo mobili in grado di sfidare il tempo nel pieno rispetto dell'ambiente", questo è il pensiero che guida e motiva ogni azione quotidiana di Riva 1920.*

## “PRODUCE TO HAND DOWN TRADITIONS”

*To produce with honesty in order to hand down traditions to future generations, making furniture that defy time and fully respect our surroundings", this has been the idea that has guided and motivated every daily action of Riva 1920.*

## “PRODUZIEREN UM ZU ÜBERLIEFERN”

*Ehrlich und aufrichtig produzieren, um den zukünftigen Generationen nachhaltige Möbelstücke zu überliefern, die den Zeichen der Zeit widerstehen können." Dieser Gedanke ist das Leitmotiv jeder alltäglichen Handlung von Riva 1920.*

INDICE · INDEX · INHALT



FILOSOFIA  
PHILOSOPHY 4  
PHILOSOPHIE

26

TAVOLI  
TABLES  
TISCHE



TAVOLINI  
SMALL TABLES 104  
COUCHTISCHE

116

SEDIE  
CHAIRS  
STÜHLE



PANCHE  
BENCHES 144  
BÄNKE

158

SGABELLI  
STOOLS  
HOCKER



CONTENITORI  
PIECES OF FURNITURE 174  
MÖBEL

222

LIBRERIE  
BOOKSHELVES  
REGALSYSTEME



SCRITTOI  
WRITING DESKS 244  
SCHREIBTISCHE

252

POLTRONE  
ARMCHAIRS  
SESSEL



DIVANI  
SOFAS 274  
SOFAS

292

FINITURE  
FINISHES  
AUSFÜHRUNGEN



## RIVA 1920

Riva 1920 racconta di un dialogo ininterrotto tra estetica ed etica. La storia di un'azienda con solide radici e una grande artigianalità, che da 100 anni coniuga innovazione e design nel rispetto dell'ambiente e della migliore tradizione del Made in Italy. Collaborando con i principali protagonisti di architettura e arte, si distingue per la produzione di arredi di eccellente qualità in cui il legno è il protagonista indiscusso, dando vita a qualcosa di speciale, unico e senza tempo.

*Riva 1920 tells of an uninterrupted dialogue between aesthetics and ethics. The story of a company with solid roots and great craftsmanship, which for 100 years combines innovation and design with respect for the environment and the best tradition of Made in Italy. It cooperates with the main protagonists of architecture and art and stands out for the production of excellent quality furniture in which wood is the undisputed protagonist, giving life to something special, unique and timeless.*

*Riva 1920 Geschichte erzählt von einem ununterbrochenen Dialog zwischen Ästhetik und Ethik. Ein Unternehmen mit starken Wurzeln in der traditionellen Handwerkskunst, das seit 100 Jahren Innovation und Design im vollen Respekt der Umwelt und der Tradition des „Made in Italy“ verbindet. Dank der Zusammenarbeit mit den wichtigsten Protagonisten der Architektur und der Kunst, zeichnet sich Riva 1920 durch die Produktion von hochwertigen, einzigartigen und zeitlosen Einrichtungsmöbeln, bei denen Holz der unbestrittene Protagonist ist.*



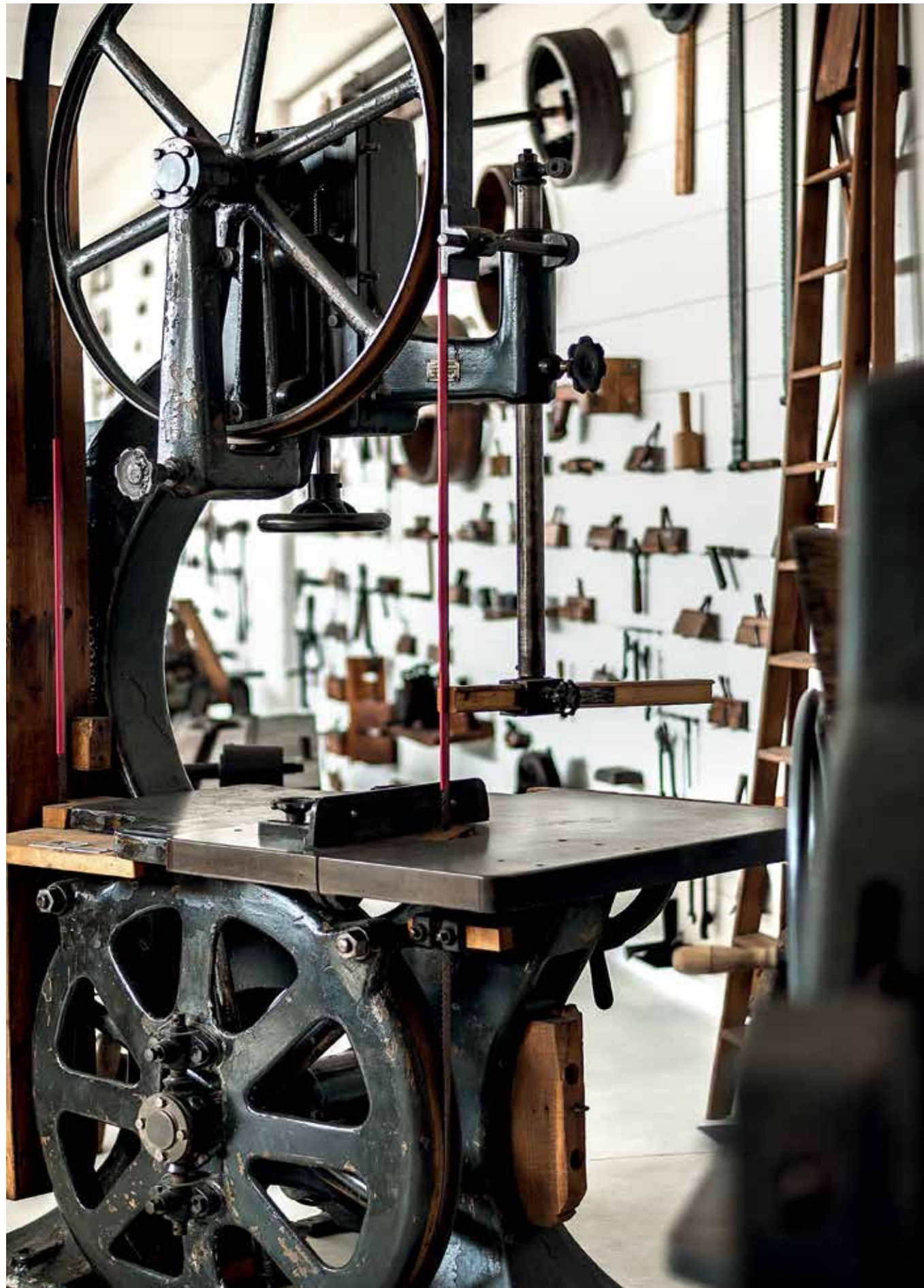

## 100 ANNI DI STORIA

Tutto nasce nel 1920 a Cantù, nel cuore della Brianza, in una piccola bottega artigiana a conduzione familiare specializzata nella produzione di arredi in legno massello dallo stile classico. Oggi alla guida dell'azienda ci sono i fratelli Maurizio, Davide ed Anna Riva che, seguendo le orme del padre e del nonno, si impegnano costantemente a favore della valorizzazione del legno naturale e della lavorazione manuale. "Produrre con onestà per tramandare alle generazioni future, costruendo mobili in grado di sfidare il tempo nel pieno rispetto dell'ambiente", da 100 anni questo è il pensiero che guida e motiva ogni azione quotidiana dell'azienda.

## 100 YEARS OF HISTORY

*Everything started in 1920 in Cantù, in the heart of Brianza, in a small family-run artisan workshop specializing in the production of classic style solid wood furniture.*

*Today the company is led by the brothers Maurizio, Davide and Anna Riva who, following in the footsteps of their father and grandfather, are constantly committed to promoting natural wood and manual processing.*

*"Produce with honesty to hand down traditions, making furniture that can challenge time in full respect of the environment", since 100 years this is the thought that guides and motivates every daily action of the company.*

## 100 JAHRE GESCHICHTE

*Alles beginnt im Jahr 1920 in Cantù, im Herzen von Brianza, in einem kleinen familiengeführten Handwerksbetrieb, der auf die Herstellung von Massivholzmöbeln im klassischen Stil spezialisiert ist. Heute sind die Brüder Maurizio, Davide und Anna Riva an der Spitze des Unternehmens und sie setzen die Arbeit des Vaters und des Großvaters fort, mit großer Achtung an die Aufwertung des Holzes und des Handwerks. "Ehrliche Handarbeit lässt die Tradition an zukünftige Generationen weiterleiten, im Respekt für Natur und Nachhaltigkeit", seit 100 Jahren ist dies der Gedanke, der jeden Tag die Firma leitet und motiviert.*

## I LEGNI

Salvaguardia dell'ambiente ed amore per la natura sono i principi fondamentali per Riva 1920. La qualità delle materie prime utilizzate è alla base del processo produttivo e parte dalla scelta dei legnami più pregiati. I prodotti della Collezione Riva 1920 sono realizzati in legno massello proveniente da tagli controllati e programmati utilizzando essenze come l'acero, il ciliegio, la rovere, la noce e l'olmo.

Un impegno concreto a favore della natura, anche grazie al progetto Natural Living.

## WOOD

*Environmental protection and love for nature are the main principles for Riva 1920. The quality of the raw materials used is the basis of the production process and starts with the choice of the finest woods. The products of the Riva 1920 collection are made of solid wood from controlled and programmed cuts using woods such as maple, cherry, oak, walnut and elm. A concrete commitment to nature, also thanks to the Natural Living project.*

## HÖLZER

*Umweltschutz und Liebe zur Natur sind Grundprinzipien von Riva 1920. Die Qualität der verwendeten Rohstoffe ist die Grundlage des Produktionsprozesses, der von der Auswahl der wertvollsten Hölzer wie Ahorn, Kirschbaum, Eiche, Nussbaum und Ulme beginnt. Das verwendete Massivholz kommt aus kontrollierten und programmierten Schnitten. Ein konkretes Engagement für die Natur, auch dank des Projektes Natural Living.*

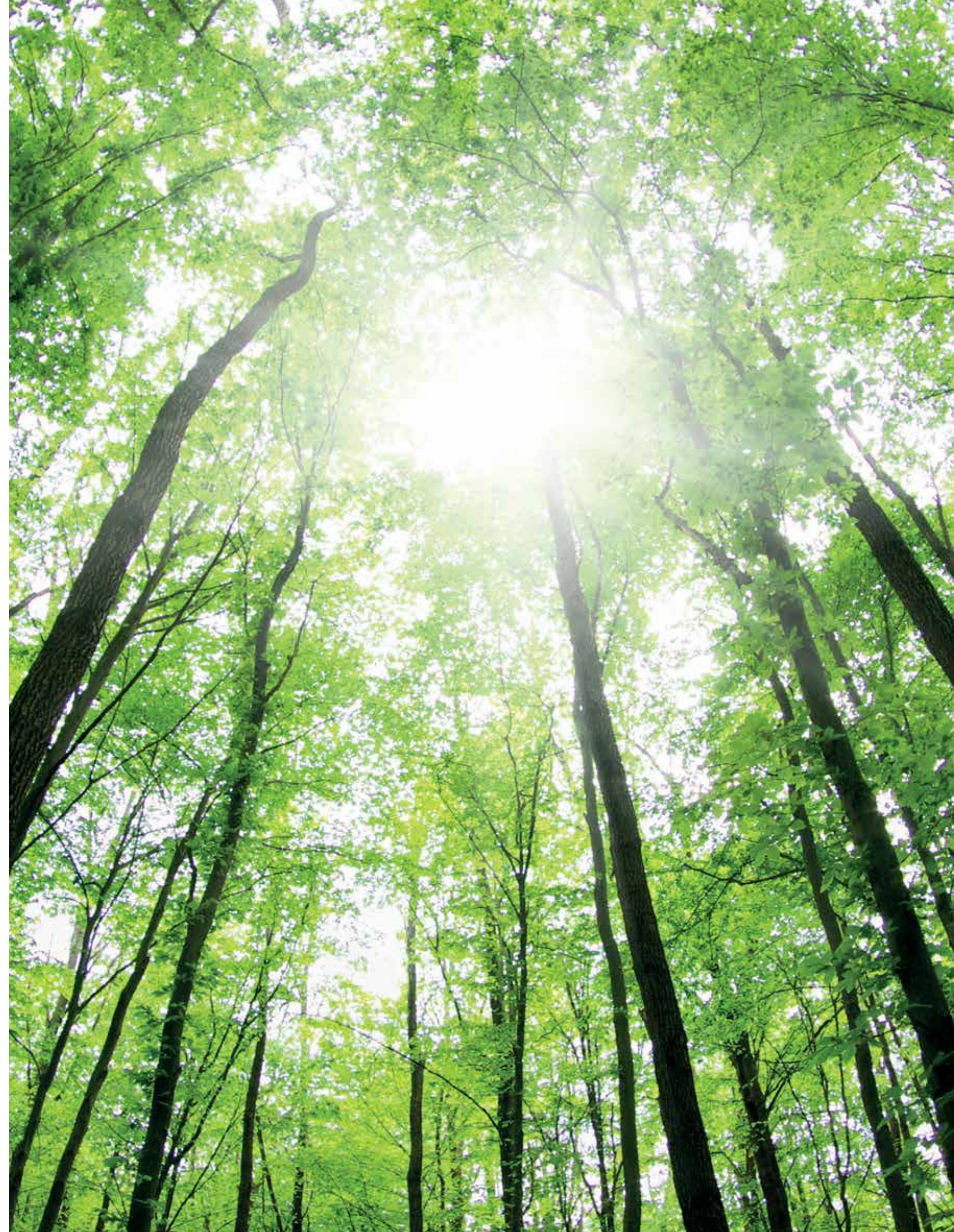



## ATELIER DELLE TAVOLE

Atelier è una parola francese che significa laboratorio e Riva 1920 gli attribuisce un significato personale. Un luogo straordinario, sito all'interno di una delle unità produttive dell'azienda che prende vita grazie a più di 200 tronchi, sezionati in assi e posizionati su rastrelliere a parete che mettono in mostra le diverse essenze: il Kauri millenario della Nuova Zelanda, il legno di Rovere europeo, la Noce americana ed europea, l'Olmo, la Tuia, il Cedro del Libano e le radici di varia tipologia. L'azienda, alla costante ricerca di pezzi singolari, uno di uno, dispone di tavole che hanno dimensioni che arrivano fino ai 12 metri di lunghezza e ai 2.40 metri di larghezza con uno spessore che va dagli 8 cm ai 14 cm.

## ATELIER: OUR WOOD HOUSE

*Atelier is a French word which means workshop and Riva 1920 gives it a personal meaning. An extraordinary space located within one of the company's premises, which comes to life thanks to more than 200 trunks, cut into slabs and placed on wall racks displaying different types of wood: the thousand-year old Kauri of New Zealand, the European Oak, the American and European Walnut, Elm, Arborvitae, Cedar of Lebanon and stumps of different wood. The company, constantly searching for one-off pieces, has slabs up to 12 meters in length and 2.40 meters in width, with a thickness ranging from 8 cm to 14 cm.*

## HOLZATELIER

*Das Wort Atelier stammt aus dem Französischen und bedeutet Werkstatt und Riva 1920 gibt diesem Wort eine persönliche Bedeutung. Das Holzatelier ist ein außergewöhnlicher Ort in einem der Produktionswerke des Unternehmens, in dem über 200 Baumstämme, in Platten gesägt: tausendjähriges Kauriholz aus Neuseeland, europäisches Eichenholz, amerikanisches und europäisches Nussbaumholz, Ulme, Lebensbaum, Zeder und verschiedene Wurzelarten. Das Unternehmen ist auf der ständigen Suche nach Unikaten und verfügt über Platten mit bis zu 12 Metern Länge, 2,40 Meter Breite und 8 bis 14 cm Stärke.*

## ARTIGIANALITA'

I prodotti Riva 1920 nascono da tecniche di lavorazione legate alla tradizione ebanista, grazie alle sapienti mani dei maestri falegnami altamente qualificati e dall'impiego di tecnologie all'avanguardia. La produzione artigiana supera le dinamiche di progettazione standard e garantisce un elevato livello di flessibilità e personalizzazione sia per la divisione home che per quella contract.

## CRAFTSMANSHIP

*Riva 1920 products are born from processing techniques linked to the cabinetmaker tradition, thanks to the skilled hands of highly qualified master carpenters and the use of cutting-edge technologies. The artisan production overcomes the dynamics of standard design and guarantees a high level of flexibility and customization both for the home division and for the contract one.*

## HANDWERKSKUNST

*Riva 1920 Produkte entstehen aus Verarbeitungstechniken, die auf die Tischlereitradition zurückgehen und sind die Frucht erfahrener Hände von ausgebildeten Tischlern und der Nutzung modernster Technologien. Die handwerkliche Produktion bietet hohe Flexibilität sowohl im „Home“ als auch im „Contract“ Bereich.*

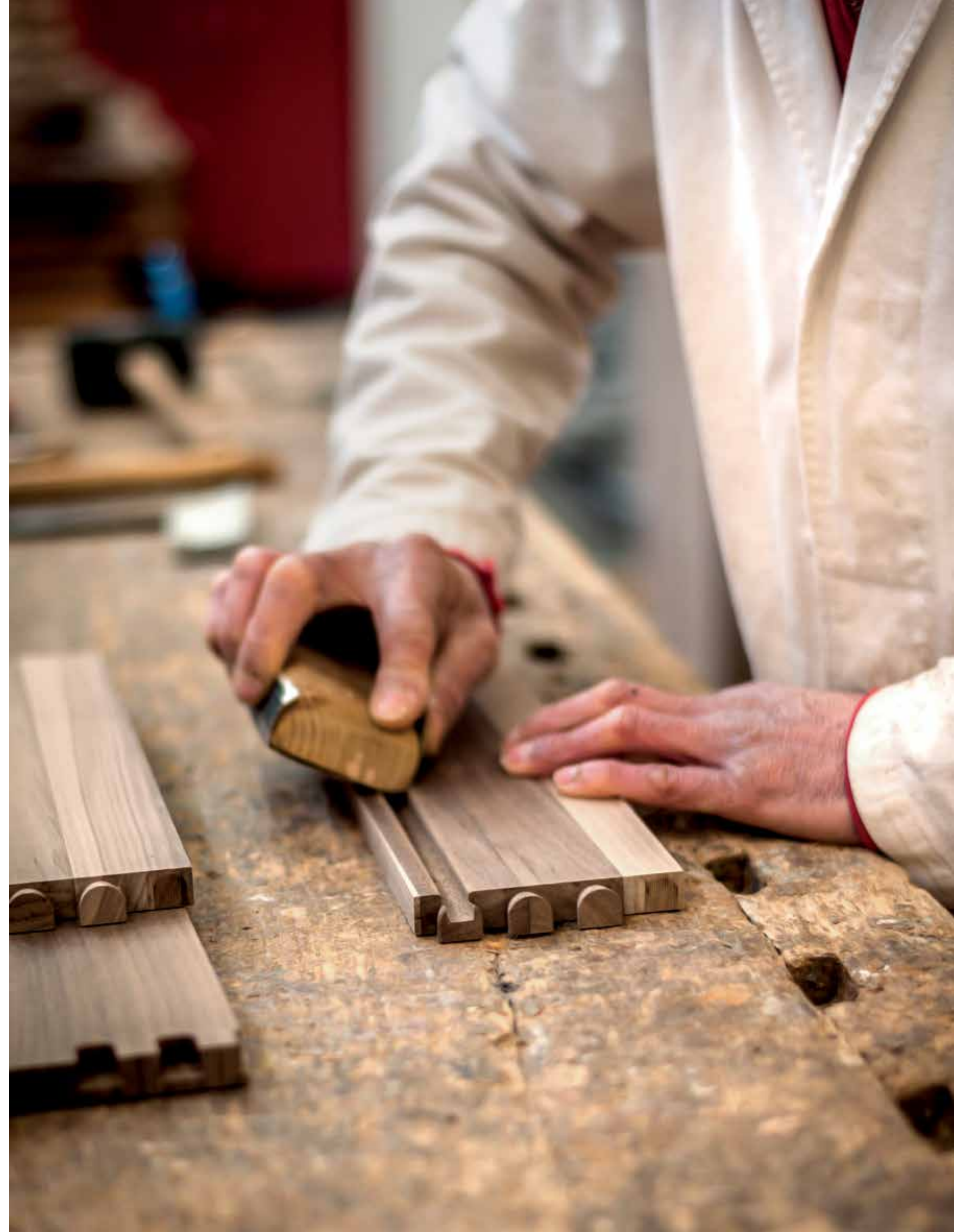



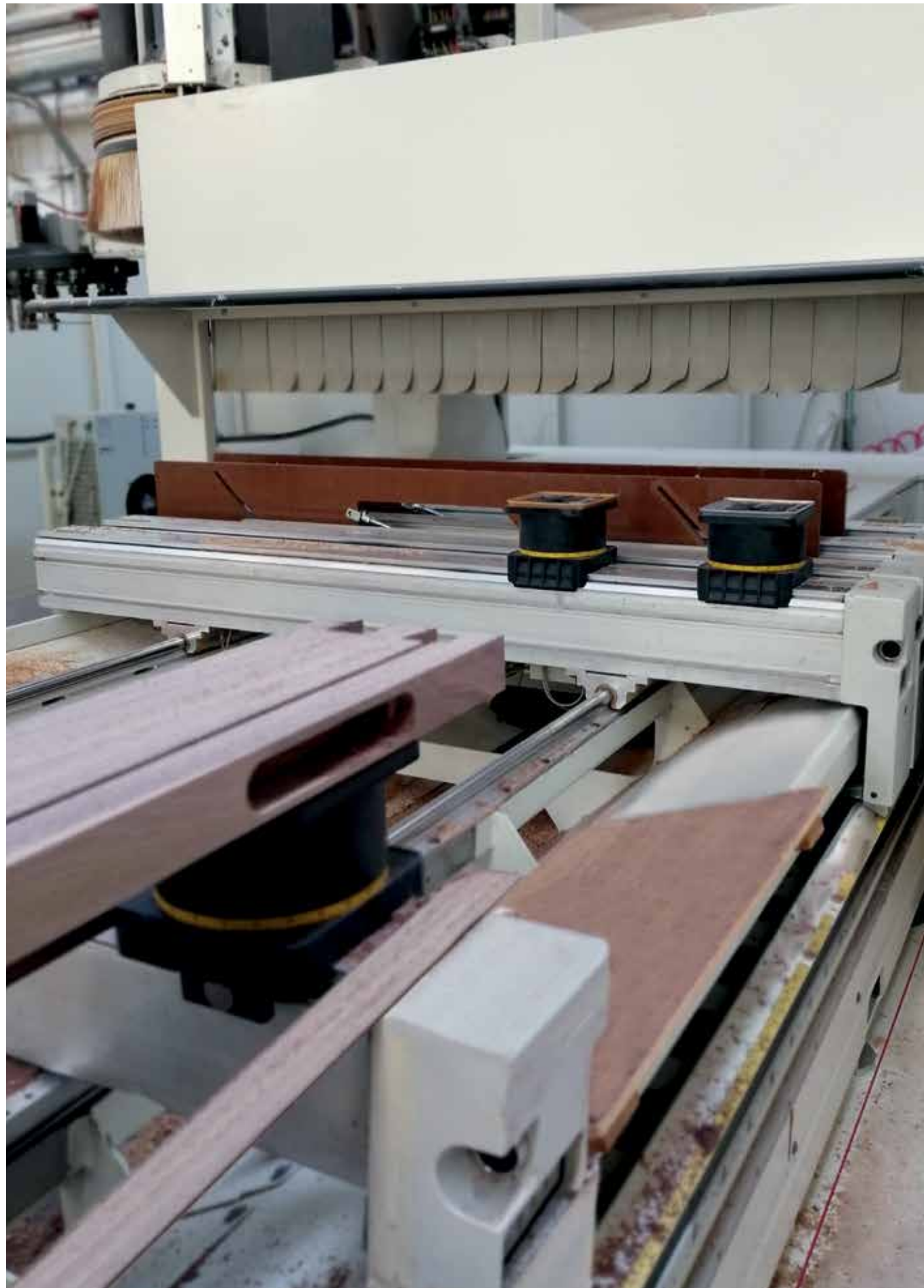

## TRADIZIONE ED INNOVAZIONE

Riva 1920 è una realtà produttiva fatta di tradizioni, cultura, creatività ed innovazione. Un'azienda dove l'artigianalità si combina con il progresso e la tecnologia, dove il design esalta le idee, l'attenzione e la cura dei dettagli danno vita a qualcosa di speciale, unico e senza tempo.

## TRADITION AND INNOVATION

*Riva 1920 is a company made of traditions, culture, creativity and innovation. A company where craftsmanship is combined with progress and technology, where design enhances ideas and the attention to details gives life to something special, unique and timeless.*

## TRADITION UND INNOVATION

*Riva 1920 ist eine Realität, die sich auf Traditionen, Kultur, Kreativität und Innovation gründet. Handwerkskunst vereinigt sich mit Fortschritt, Technologie und Design. Die Liebe zum Detail schenkt besondere, einzigartige und Zeitlose Produkte.*

## LAVORAZIONI

Il prodotto Riva 1920 è qualcosa di veramente unico nel suo genere: i legni vengono accuratamente selezionati e lavorati attraverso macchinari all'avanguardia uniti al lavoro di abili artigiani, che li rifiniscono a mano con olii o cere naturali. Taglio, bordatura, incollaggio, impiallacciatura, pressatura, levigatura, oliatura, montaggio e per finire controllo qualità. Ogni prodotto viene accuratamente assemblato e controllato prima di essere smontato ed imballato per la spedizione. Questi sono i passaggi fondamentali per arrivare al mobile finito. Solo vedendo la qualità e l'eccellenza di ogni fase del processo produttivo si può dare il giusto valore agli arredi Riva 1920.

## PROCESSING

*The Riva 1920 product is something truly unique: our woods are carefully selected and processed through cutting-edge machineries combined with the work of skilled craftsmen, who finish them by hand with natural oils or waxes. Cutting, edging, gluing, veneering, pressing, sanding, oiling, assembling and final quality control. Each product is carefully assembled and checked before being disassembled and packaged for shipping. These are the basic steps to get to the finished piece of furniture. Only by seeing the quality and excellence of each production phase you can give Riva 1920 furniture the right value.*

## VERARBEITUNG

*Das Produkt Riva 1920 ist etwas wirklich Einzigartiges: unsere Hölzer werden sorgfältig ausgewählt und mit modernsten Maschinen verarbeitet, kombiniert mit der Arbeit qualifizierter Handwerker, die sie von Hand mit natürlichen Ölen oder Wachsen bearbeiten. Schneiden, Kleben, Furnieren, Pressen, Schleifen, Ölen, Montage und schließlich Qualitätskontrolle. Jedes Produkt wird sorgfältig zusammengesetzt und geprüft, bevor es zerlegt und für den Versand verpackt wird. Dies sind die grundlegenden Schritte bis zum fertigen Möbelstück.*

*Nur wenn man die Qualität jeder Phase des Produktionsprozesses sehen kann, kann man auf die Möbel von Riva 1920 den richtigen Wert legen.*





TAVOLE IN LEGNO MASSELLO PIALATE E INCOLLATE · PLANED AND GLUED SOLID WOOD SLABS ·  
MASSIVHOLZLEISTEN GESCHLIFFEN UND VERLEIMT

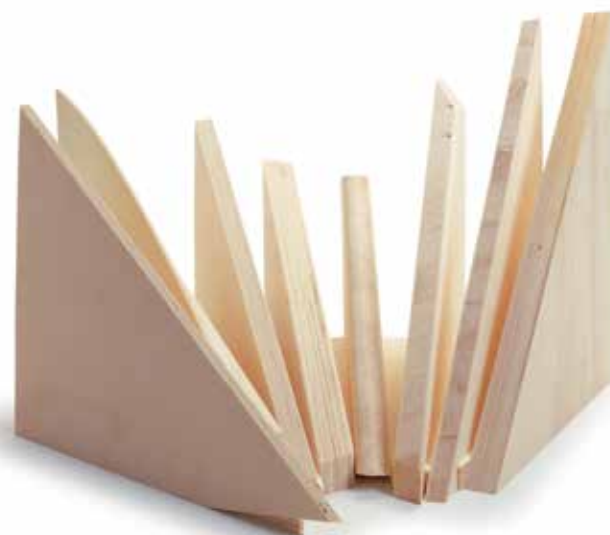

MULTISTRATO UTILIZZATO NELLA PRODUZIONE · MULTILAYER USED IN THE PRODUCTION ·  
IN PRODUKTION VERWENDETES MULTIPLEX



MULTISTRATO MASSELLATO E IMPIALLACCIATO · VENEERED BLOCKBOARD ·  
MULTIPLEX MASSIV GEKANTET UND FURNIERT



ZOCCOLO IN LEGNO MASSELLO · SOLID WOOD PLINTH ·  
SOCKEL AUS MASSIVHOLZ

## QUALITA' DEI MATERIALI

Il legno massello ed il multistrato sono i due materiali fondamentali nella produzione dei mobili a marchio Riva 1920. Il legno massello è l'ingrediente madre e vengono utilizzate essenze provenienti esclusivamente da tagli controllati e programmati. Questo significa che ogni volta che viene tagliato un albero per la produzione di mobili Riva 1920 ne vengono ripiantati degli altri, così il cerchio della vita non s'interrompe e alla natura viene restituito quel che ha donato. I pannelli multistrato (o listellare) sono invece realizzati utilizzando esclusivamente il legno di pioppo italiano proveniente dal Piemonte e dalla bassa Lombardia. Le piantagioni di pioppo crescono rapidamente (ciclo di circa 7/10 anni) ed il legname che si ricava è quindi una materia prima facilmente rinnovabile. Il multistrato utilizzato nella nostra produzione è inoltre certificato PEFC (garanzia che la materia prima legnosa deriva da foreste gestite in maniera sostenibile).

## QUALITY OF MATERIALS

*Solid wood and plywood are the two basic materials in the production of Riva 1920 brand furniture. Solid wood is the main ingredient and the only material used is wood coming exclusively from controlled and programmed cuts. This means that every time a tree is cut for the production of Riva 1920 furniture, others are planted so that the circle of life doesn't stop and nature is given back what it has given. The multilayer (or blockboard) panels are made only using Italian poplar wood from Piedmont and lower Lombardy. Poplar plantations grow rapidly (cycle of about 7/10 years) and the timber obtained is therefore an easily renewable raw material. The multilayer used in our production is also PEFC certified (guarantee that the raw material derives from sustainably managed forests).*

## QUALITÄT DER MATERIALIEN

*Massives und furniertes Holz sind beide Grundmaterialien für die Herstellung von Riva 1920 Möbeln. Massivholz ist das Hauptelement und das verwendete Material ist zertifiziert und stammt aus programmierten Fällen. Dies bedeutet, dass jedes Mal, wenn ein Baum für die Herstellung von Riva 1920-Möbeln gefällt wird, neue Bäume gepflanzt werden, sodass der Kreislauf des Lebens nicht unterbrochen wird. Tischlerplatte und Multiplex werden aus italienischem Pappelholz aus den Regionen Piemont und Lombardei hergestellt. Pappelplantagen wachsen schnell (Zyklus von ca. 7/10 Jahren) und das gewonnene Holz ist daher ein leicht nachwachsender Rohstoff. Das in unserer Produktion verwendete Multiplex ist ebenfalls PEFC-zertifiziert (Garantie, dass die Rohstoffen aus nachhaltig bewirtschafteten Wäldern stammen).*

## TRADIZIONE EBANISTA: L'INCASTRO A CODA DI RONDINE

Il prodotto Riva 1920 si contraddistingue per l'incastro a coda di rondine, tipico elemento della tradizione ebanista, caratterizzato da una serie di elementi maschi e femmine perfettamente complementari che vengono assemblati insieme a pressione. Queste giunzioni ad angolo retto sono particolarmente valide per la realizzazione non solo dei cassetti ma anche di altri elementi costruttivi degli arredi e contribuiscono al valore estetico ed alla robustezza del manufatto.

## CABINET-MAKING TRADITION: DOVETAIL JOINT

*The Riva 1920 product is characterized by the dovetail joint, a typical element of the cabinet-making tradition, characterized by tongue and groove elements, which are perfectly complementary and are fitted together by pressure. These joints are particularly suitable not only to make the drawers but also for other construction elements of the furnishings and contribute to the aesthetic value and strength of the product.*

## TISCHLEREITRADITION: SCHWALBENSCHWANZVERBINDUNG

*Das Produkt Riva 1920 zeichnet sich durch die Schwalbenschwanzverbindungen aus, eine typische Verarbeitung der Tischlereitradition. Eine Technik die sich durch Elemente „Nut und Feder“ gekennzeichnet ist. Diese Verbindungen sind besonders geeignet nicht nur für Schubladen, sondern auch für die Möbelkonstruktion und geben dem Produkt einen ästhetischen Wert.*

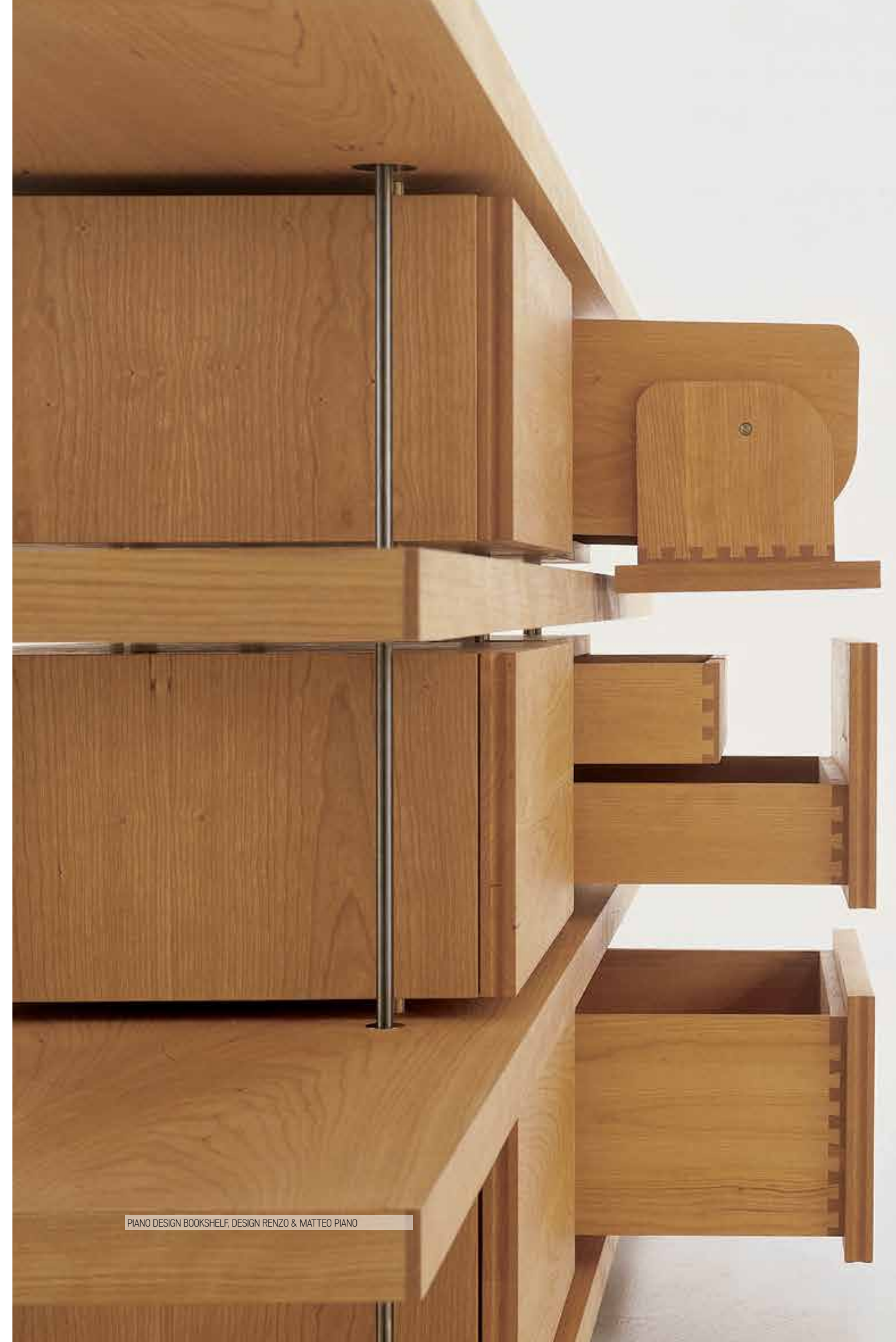

PIANO DESIGN BOOKSHELF, DESIGN RENZO & MATTEO PIANO



## BASSO IMPATTO AMBIENTALE

Nel petto dell'azienda batte un cuore fatto di legno. Riva 1920 ama la natura, ma anche i suoi clienti ed è per questo che offre un prodotto autentico fatto in legno nel pieno rispetto dell'ambiente e delle persone che lo abitano. Ogni elemento è sottoposto a dettagliate verifiche di conformità qualitativa e funzionale alle quali si aggiunge l'impiego di collanti vinilici e finiture ad olio e cera vegetale, garanzia di un prodotto autentico e completamente naturale. Riva 1920 pone particolare attenzione anche alla fase di imballaggio dei propri prodotti, utilizzando esclusivamente imballi in cartone con Certificazione FSC Forest Stewardship Council, realizzati con l'utilizzo di cellulosa proveniente da foreste gestite secondo i criteri della gestione forestale sostenibile.

## ENVIRONMENTALLY FRIENDLY

*A heart made of wood beats in the chest of the company. Riva 1920 loves nature, but also its customers and that is why it offers an authentic product made of real natural wood, in full respect of the environment and the people who live there.*

*Each element is subjected to detailed quality and functional conformity checks, to which is added the use of vinyl glues and finish based on vegetable wax and oil, a guarantee of an authentic and completely natural product.*

## GERINGE UMWELTAUSWIRKUNGEN

*Ein Herz aus Holz schlägt in der Brust des Unternehmens. Fa. Riva 1920 liebt die Natur und achtet auf Kunden, deswegen bietet ein authentisches Produkt, aus Holz und in voller Respekt der Umwelt und der Menschen gefertigt. Es wird sorgfältig geprüft, dass jedes Element den hohen Qualitätsstandards entspricht. Die Verwendung von Vinylklebern und Öl- oder Wachsbehandlungen sind Garantie eines natürlichen Produktes. Riva 1920 legt auch besonderes Augenmerk auf die Verpackungsphase seiner Produkte, wobei ausschließlich Kartonverpackungen mit FSC Forest Stewardship Council-Zertifizierung verwendet werden, die unter Nutzung von Zellulose aus Wäldern hergestellt werden, die nach Kriterien der nachhaltigen Waldbewirtschaftung geregelt werden.*

## COLLEZIONE ZONA GIORNO

Ricca selezione di pezzi iconici per arredare la zona living con grande personalità e carattere all'insegna di una raffinata eleganza e di uno stile autentico. Suggestioni ed emozioni, che scaturiscono dal legno declinato in una molteplicità di forme versatili e funzionali massima espressione dell'artigianalità, dell'esperienza e dell'innovazione. Valori che si sviluppano attraverso soluzioni esclusive che stupiscono per la cura per i dettagli, la qualità delle materie prime utilizzate e la possibilità di personalizzazioni su misura. Un design ecologico e sostenibile, dal grande valore intrinseco, che si fa interprete di uno spazio dell'abitare senza tempo, da tramandare e custodire.

### LIVING AREA COLLECTION

*A rich selection of iconic pieces to furnish the living area with great personality and character, in the pursuit of refined elegance and authentic style. Atmosphere and emotions which arise from the wood declined in a multiplicity of versatile and functional shapes, maximum expression of craftsmanship, experience and innovation. Values that develop through exclusive solutions that amaze for the attention to detail, the quality of the raw materials used and the possibility of customized furniture. An ecological and sustainable design, of great intrinsic value, which becomes the interpreter of a timeless living space, to be handed down and preserved.*

### WOHNBEREICH KOLLEKTION

*Eine breite Auswahl von ikonischen Produkten, um den Wohnbereich mit Charakter, Eleganz und Stil einzurichten. Gefühle und Emotionen, die das Holz in seinen vielfältigen Formen und Ausführungen weckt. Produkte die sich durch Einzigartigkeit, Achten auf Details, Qualität der Rohstoffen und Flexibilität auszeichnen.*





TAVOLI · TABLES · TISCHE



AMBO 28-29



BEDROCK PLANK C 30-33



BEDROCK PLANK C RESIN 34-35



BOSS BASIC 36-37



BOSS EXECUTIVE 38-41



BREE E ONDA 42-43



BUNGALOW BAR TABLE 44-45



CALLE CULT 46-49



CANAL 50-53



CELERINA 54-55



D.T. TABLE 56-57



DARWIN 58-59



IRON LIGHT 60-61



LIAM 62-65



LIGHT 66-67



MESA 68-69



NATURA 70-73



NEWTON 74-77



OMBRA TABLE 78-79



PANDANUS 80-81



PARLA BIG & SMALL 82-83



PRIME WOOD EXTENDABLE 84-87



PRIME WOOD FIX 88-89



SHANG 90-91



SKY-NATURA 92-95



SLEEK 96-99



FRAME · FRAME RESIN 100-101



FRAME BAR 102-103

**AMBO**

Tavolo con top realizzato a liste incollate con fuga centrale e bordi diritti. Base composta da gambe in lamiera di ferro caratterizzata da linee geometriche, realizzato per la Sala del Cartone di Raffaello, Museo Ambrosiano di Milano.

Qui e nella pagina a sinistra: top rovere con nodi neutro e base in ferro laccato colore iron dust.

*Table with top in glued lists, with middle gap and straight sides. Base in iron plate characterised by geometric lines, designed to furnish a room in Milan's Museo Ambrosiano next to one of Raffaello's masterpieces. In the pictures: top in neutro oak with knots and iron base lacquered iron dust.*

*Tisch mit Platte bestehend aus verleimten Massivholzleisten mit Mittelfuge und geraden Kanten. Gestell mit geometrischem Design aus Eisen gefertigt. Der Tisch wurde für ein Zimmer im Mailänder Museo Ambrosiano neben einem von Raffaellos Meisterwerken entworfen.*

*In den Fotos: Platte aus Eiche mit Knoten neutro und Untergestell aus Eisen lackiert Iron dust.*

CM: L. 200/220/240/260/280/300 · P. 100 · H. 75

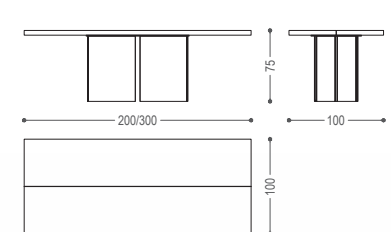



## BEDROCK PLANK C

TERRY DWAN



CM: L. 220/240/260/280/300 · P. 90/100 · H. 76

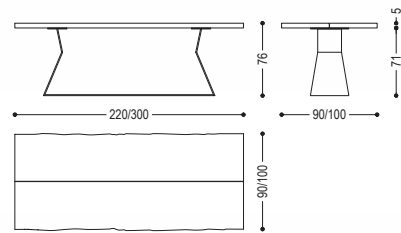

Per maggiori informazioni consultare il Pricelist  
For any further information please refer to the Pricelist  
Weitere Informationen entnehmen Sie bitte der Preisliste



Tavolo con top realizzato in legno massello, composto da due tavole uniche allineate con fuga centrale e bordi naturali. A richiesta disponibile con tavole disallineate di 30 cm (Bedrock Plank B). Base in lamiera di ferro caratterizzata da linee geometriche.

Qui: top noce con nodi, finitura olio e base in ferro laccato trasparente opaco - top rovere con nodi, finitura cera e base in ferro laccato trasparente opaco. A destra e nelle pagine successive: top noce con nodi, finitura olio e base in ferro laccato trasparente opaco.

*Table with top made of solid wood, consisting of two single planks aligned, with middle gap and natural sides. Upon request available with asymmetrical planks, disaligned of 30 cm (Bedrock Plank B). Base in iron plate characterised by geometric lines.*

*On this page: top in walnut with knots, oil finish and iron base matt transparent lacquered - top in oak with knots, wax finish and iron base matt transparent lacquered. On the following pages: top in walnut with knots, oil finish and iron base matt transparent lacquered.*

*Tisch mit Platte aus Massivholz, bestehend aus zwei Planken mit Naturkanten und Mittelfuge. Auf Anfrage Planken um 30 cm verschoben positioniert (Bedrock Plank B). Gestell mit geometrischem Design aus Eisen gefertigt.*

*In den Fotos: Platte aus Nussbaum mit Knoten geölt und Gestell aus Natureisen matt transparent lackiert - Platte aus Eiche mit Knoten gewachst und Gestell aus Natureisen matt transparent lackiert. Auf den folgenden Seiten: Platte aus Nussbaum mit Knoten geölt und Gestell aus Natureisen matt transparent lackiert.*





## BEDROCK PLANK C RESIN

TERRY DWAN



CM: L. 220/240/260/280/300 · P. 90/100 · H. 76

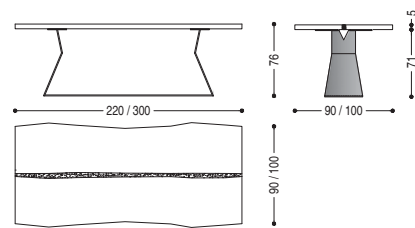

Tavolo con top realizzato in legno massello, composto da due tavole uniche con bordi naturali; al centro una elegante striscia di resina trasparente per la versione in noce e resina nera per la versione in rovere. Base in lamiera di ferro caratterizzata da linee geometriche.

Qui: top noce, finitura olio con resina trasparente e base in ferro laccato trasparente opaco. Particolare del top: noce con resina trasparente - rovere con resina nera. Nella pagina a destra: top rovere finitura cera, con inserto in resina nera, base in ferro laccato trasparente opaco.

*Table with top made of solid wood, consisting of two single planks with natural sides joined through a refined central resin filling. Walnut combined with transparent resin and oak combined with black resin. Base in iron plate characterised by geometric lines.*

*On this page: top in walnut with transparent resin and base in natural iron matt transparent lacquered. Detail of the top: walnut with transparent resin - oak with black resin. On the next page: top in oak with black resin.*

*Tisch mit Platte aus Massivholz, bestehend aus zwei Planken mit Naturkanten. Mittelfuge mit transparentem Kunstharz (bei der Variante Nussbaum) oder mit schwarzem Kunstharz (bei der Variante Eiche) ausgefüllt. Gestell mit geometrischem Design aus Eisen gefertigt.*

*In den Fotos: Platte aus Nussbaum mit transparentem Kunstharz. Details: Nussbaum mit transparentem Kunstharz - Eiche mit schwarzem Kunstharz. Auf der nächsten Seite: Platte aus Eiche mit schwarzem Kunstharz.*



## BOSS BASIC

C.R.&S. RIVA1920



Tavolo realizzato interamente in legno massello, disponibile con top ovale, quadrato e rettangolare, con gambe a liste vuote all'interno con o senza basamento in ferro.

Qui e nella pagina sinistra: top e gamba rovere con nodi neutro e base in ferro laccato trasparente opaco.

*Table made entirely in solid wood, available in oval, squared and rectangular shapes. The legs are composed of glued lists, with or without an iron floor plate.*

*In the pictures: top and leg in neutro oak with knots and natural iron floor plate matt transparent lacquered.*

*Tisch völlig aus Massivholz, mit ovaler, quadratischer oder rechteckiger Platte erhältlich. Beine aus verleimten Leisten, innen leer, mit oder ohne Bodenplatte aus Eisen.*

*In den Fotos: Platte und Bein aus Eiche mit Knoten neutro und Bodenplatte aus Natureisen matt transparent lackiert.*

CM: L. 200/240/260 · P. 100/110 · H. 73,5

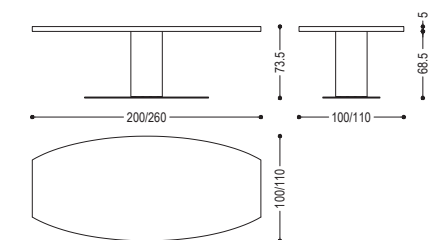

Per maggiori informazioni consultare il Pricelist  
For any further information please refer to the Pricelist  
Weitere Informationen entnehmen Sie bitte der Preisliste



**BOSS EXECUTIVE**

C.R.&S. RIVA1920



CM: L. 240/260/280/300 · P. 100/110 · H. 73,5

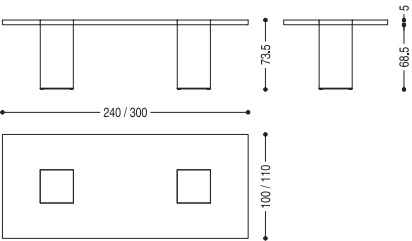

Per maggiori informazioni consultare il Pricelist  
 For any further information please refer to the Pricelist  
 Weitere Informationen entnehmen Sie bitte der Preisliste

Tavolo realizzato in legno massello a liste incollate che si caratterizza per le gambe passanti a vista sul top, ricavate da sezioni di tronchi d'albero. Disponibile nelle varianti: ovale, rotondo, quadrato e rettangolare. Qui, a sinistra e nelle pagine successive: top e gamba rovere con nodi, finitura cera.

*Table with top made of solid wood in glued lists, characterised by legs passing through the top surface, made from sections of tree trunks. Available in oval, round, squared and rectangular shape. In the pictures: top and legs in oak with knots, wax finish.*

*Tisch mit Platte bestehend aus verleimten Massivholzleisten und Beine aus Massivholzblöcken durch die Platte durchstossend. In ovaler, runder, quadratischer oder rechteckiger Form erhältlich. In den Fotos: Platte und Beine aus Eiche mit Knoten gewachst.*





## BREE E ONDA

PASSON & SAVORGNANI



Tavolo con top realizzato in legno massello a liste incollate con lati squadri, abbinato ad una particolare gamba dotata di forma sinuosa che ricorda le onde del mare.

Qui: top noce senza nodi, finitura olio e base ferro laccato irondust. Nella pagina di destra: top rovere con nodi, finitura cera e base ferro laccato irondust.

*Table with top made of solid wood in glued lists and straight sides, combined with a particular leg characterised by a sinuous shape that brings to mind the sea's waves.*

*On this page: top in walnut without knots, oil finish, and iron base lacquered irondust. On the next page: top in oak without knots, wax finish, and iron base lacquered irondust.*

*Tisch mit Platte bestehend aus verleimten Massivholzleisten und Gestell aus Eisen, das an die Meereswellen erinnert.*

*Auf dieser Seite: Platte aus Nussbaum ohne Knoten geölt und Gestell lackiert irondust. Auf der nächsten Seite: Platte aus Eiche ohne Knoten gewachst und Gestell lackiert irondust.*

CM: L. 240/260/280/300 · P. 100 · H. 76

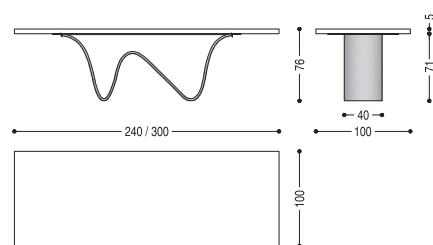

## BUNGALOW BAR TABLE

JAMIE DURIE

Tavolo da bar composto da struttura in legno massello completamente tornita, assemblata e levigata a mano, con base d'appoggio squadrata abbinata ad un top in legno o marmo con lati smussati e sporgenti.

Qui: struttura e top rovere senza nodi, finitura cera - struttura in teak, finitura olio, e top in Marmo Emperador Dark.

*Bar table with structure in solid wood turned, assembled and smoothed by hand, with square-shaped base combined with a wooden or marble top with rounded and protruding edges.*

*In the pictures: structure and top in oak - structure in teak and marble top.*

*Steh Tisch mit Untergestell aus Massivholz mit quadratischer Grundfläche, von Hand gedreht, aufgebaut und geschliffen. Tischplatte aus Holz oder Marmor mit hervorstehenden, abgerundeten Kanten.*

*In den Fotos: Untergestell und Platte aus Eiche - Untergestell aus Teak und Marmorplatte.*

BUNGALOW BAR TABLE WOOD

BUNGALOW BAR TABLE MARBLE

CM: L. 100/120 · P. 100/120 · H. 103,5

CM: L. 100 · P. 100 · H. 103,5

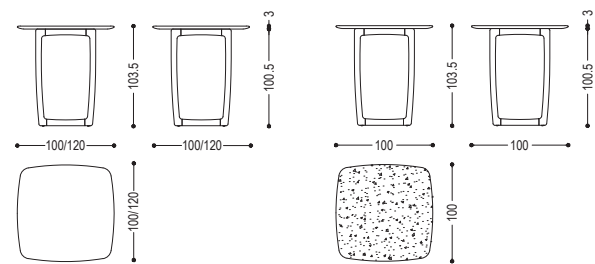

Collezione Bungalow proposta nella versione Outdoor (finiture: legno teak di riforestazione e tessuto Patio).

Bungalow collection proposed in the Outdoor version (finishes: teak wood from reforestation areas and Patio fabric).

Kollektion Bungalow in der Version für den Outdoor (Ausführungen: Teakholz aus Wiederaufforstungsgebieten und Stoff Patio).





## CALLE CULT

ALDO SPINELLI



Tavolo con top realizzato in legno massello a liste accostate con bordi naturali, abbinato ad una struttura in ferro chiaro composta da due gambe a slitta e barra centrale.

Qui: top noce con nodi, finitura olio e base ferro laccato effetto acciaio spazzolato opaco. A sinistra: top noce con nodi, finitura olio e base ferro laccato Ral 1013. Nelle pagine a seguire top finitura rovere tabacco e base ferro laccato effetto acciaio spazzolato opaco.

*Table with top in solid wood planks, not glued, with natural sides combined with an iron base, light colour, consisting of two U-shaped legs and a central bar.*

*On this page: top in walnut with knots, oil finish and iron base lacquered stainless steel matt brushed effect. On the left: top in walnut with knots, oil finish and iron base lacquered RAL 1013. On the following page: top in tobacco oak and iron base lacquered stainless steel matt brushed effect.*

*Tisch mit Platte aus Brettern, nicht verleimt und mit Naturkanten, und Gestell aus Natureisen bestehend aus zwei Beinen und einer Traverse.*

*Auf dieser Seite: Platte aus Nussbaum mit Knoten geölt und Gestell lackiert Edelstahl-Effekt matt gebürstet. Links: Platte aus Nussbaum mit Knoten geölt und Gestell lackiert RAL 1013. Auf der nächsten Seite: Platte aus Eiche Tabacco und Gestell lackiert Edelstahl-Effekt matt gebürstet.*

CM: L. 220/240/260/280/300 · P. 90/100 · H. 73

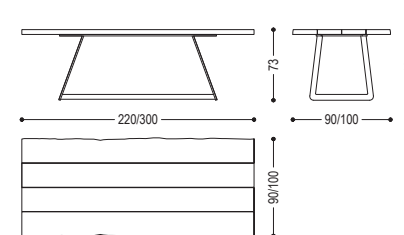



# CANAL

PATRICIA URQUIOLA



CM: L. 220/240/260 · P. 110 · H. 76,8

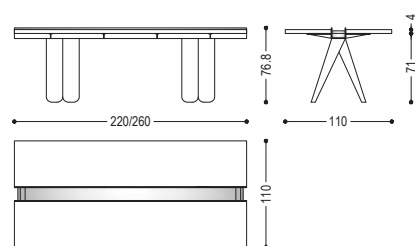

Tavolo con top realizzato in legno massello, a liste incollate e lati squadrati. Dotato di vano centrale in ferro con funzione contenitiva. A sorreggere il piano quattro possenti gambe a sezione geometrica.

Qui: top e struttura noce con nodi, finitura olio e vano centrale in ferro laccato iron dust - ferro laccato effetto rame antico spazzolato opaco. A destra e nelle pagine successive: top e struttura rovere senza nodi, finitura cera e vano centrale in ferro laccato iron dust.

*Table made in solid wood, its top in glued lists and straight sides, with a central iron compartment to store objects. The top is supported by four legs with a geometrical section.*

*On this page: top and legs in walnut with knots, oil finish and iron compartment lacquered iron dust and lacquered aged copper matt brushed effect. On the following pages: top and legs in oak with knots, wax finish and iron compartment lacquered iron dust.*

*Tisch mit Platte bestehend aus verleimten Massivholzleisten, mit geraden Kanten; in der Mitte des Tisches befindet sich eine Einbuchtung in Form eines Eisenbehälters, der sich über die komplette Länge des Tisches erstreckt. Vier massive Beine stützen die Tischplatte.*

*Auf dieser Seite: Platte und Beine aus Nussbaum mit Knoten geölt und Eisenbehälter lackiert iron dust und lackiert Kupfer-Effekt matt gebürstet. Auf den nächsten Seiten: Platte und Beine aus Eiche mit Knoten gewachst und Eisenbehälter lackiert iron dust.*





## CELERINA

MATTEO THUN

Tavolo realizzato interamente in legno massello a liste incollate, con fuga centrale e gambe passanti a vista sul top. Top disponibile con profilo smussato oppure dritto.

Qui e nella pagina destra: top e struttura noce con nodi, finitura olio.

*Table made entirely of solid wood in glued lists, with central gap and with the legs visible on the top surface. Available with top profile rounded or straight.*

*In the pictures: top and legs in walnut, oil finish.*

*Tisch mit Platte bestehend aus verleimten Massivholzleisten, mit einer Mittelfuge. Beine aus Massivholz durch die Platte durchstossend. Mit abgerundeten oder geraden Kanten erhältlich.*

*In den Fotos: Platte und Beine aus Nussbaum geölt.*

CM: L. 180/200/220/240/260/280/300 · P. 100 · H. 75

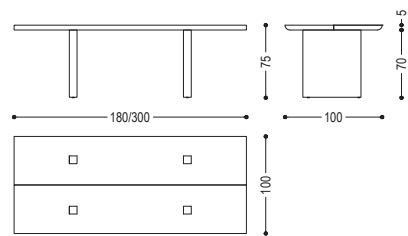

## D.T. TABLE

Tavolo con top in legno massello a liste incollate e bordi naturali o squadri caratterizzato da base in ferro con gambe a slitta assemblate con incastrati a coda di rondine. Disponibile anche nella versione Plank con top in legno massello composto da due tavole uniche con fuga centrale e bordi naturali.

Qui e nella pagina destra: top rovere con nodi tabacco e base ferro laccato irondust.

*Table with solid wood top in glued lists and natural or straight sides, characterized by an iron base with legs in U-shape assembled with dove tail joints. Also available with top in two single planks with middle gap and natural sides.*

*In the pictures: tabacco oak with knots and iron base lacquered irondust.*

*Tisch mit Platte bestehend aus verleimten Massivholzleisten, mit geraden oder Naturkanten. Gestell bestehend aus Eisenkufen, deren Einzelteile mit Schwalbenschwanzverbindungen zusammengefügt sind. Auch in der Variante mit Platte bestehend aus zwei Planken mit Naturkanten und Mittelfuge.*

*In den Fotos: Platte aus Eiche mit Knoten Tabacco und Gestell lackiert irondust.*

CM: L. 220/240/260/280/300 · P. 100 · H. 76

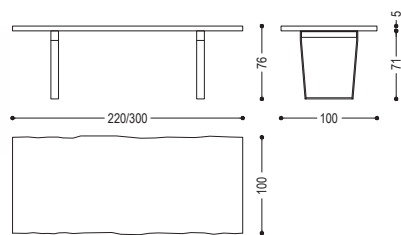

C.R. & S. RIVA1920



## DARWIN

C.R. & S. RIVA1920



Tavolo con top in legno massello a liste incollate con bordi naturali o squadrati, abbinato ad una base in ferro chiaro composta da due gambe piatte.

Qui: top noce senza nodi, finitura olio e base in ferro naturale chiaro spazzolato, finitura trasparente opaco. Nella pagina sinistra: top rovere senza nodi, finitura cera e base ferro laccato Ral 1013.

*Table with solid wood top in glued lists with natural or straight sides, combined with an iron base, light colour, consisting of two flat legs.*

*On this page: top in walnut without knots, oil finish and brushed natural iron base, light colour, matt transparent lacquered. On the left: top in oak with knots, wax finish and iron base lacquered RAL 1013.*

*Tisch mit Platte bestehend aus verleimten Massivholzleisten, mit geraden oder Naturkanten geraden Kanten. Gestell bestehend aus 2 Flachbeinen aus Eisen.*

*Auf dieser Seite: Platte aus Nussbaum mit Knoten geölt und Gestell aus hellem Natureisen, gebürstet und matt transparent lackiert. Links: Platte aus Eiche mit Knoten gewachst und Gestell lackiert RAL 1013.*

CM: L. 160/180/200/220/240/260/280/300 · P. 90/100 · H. 75

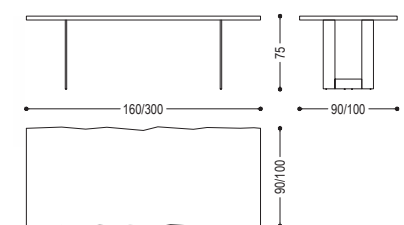

## IRON LIGHT

GIOVANNA AZZARELLO

Tavolo composto da top in legno massello a liste incollate con bordi naturali o squadri, abbinato ad una base essenziale e lineare formata da un tubolare intrecciato in ferro vuoto. Disponibile a richiesta in tubolare intrecciato in ferro pieno e con top in vetro.

Qui: top noce con nodi, finitura olio e base ferro laccato Irondust - top vetro e base ferro laccato irondust. A destra: top rovere con nodi neutro, bordi rovere total black e base ferro laccato irondust.

*Table with top in glued solid wood lists, with natural or straight sides, combined with a basic and linear base made of intertwined tubular iron, empty inside. Upon request available in intertwined full tubular iron and with glass top.*

*On this page: top in walnut and iron base lacquered irondust - glass top and iron base lacquered irondust. On the next page: top in neutro oak with knots, total black pigmented edges and iron base lacquered irondust.*

*Tisch mit Platte bestehend aus verleimten Massivholzleisten, mit geraden oder Naturkanten. Mit essentiellm und linearem Design, besteht das Untergestell aus einem gebogenen hohlen Stahlrohr. Auf Anfrage aus einem gebogenem vollem Stahlrohr und mit Glasplatte erhältlich.*

*Auf dieser Seite: Platte aus Nussbaum und Gestell lackiert irondust - Glasplatte und Gestell lackiert irondust. Auf der nächsten Seite: Platte aus Eiche mit Knoten neutro, mit total black pigmentierten Kanten, und Gestell lackiert irondust.*



CM: L. 200/220/240/260/280/300 · P. 100 · H. 75,5

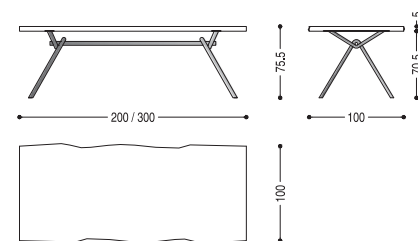

Per maggiori informazioni consultare il Pricelist  
For any further information please refer to the Pricelist  
Weitere Informationen entnehmen Sie bitte der Preisliste







## LIAM

C.R.&S. RIVA1920



CM: L. 200/220/240/260 · P. 100/110 · H. 75

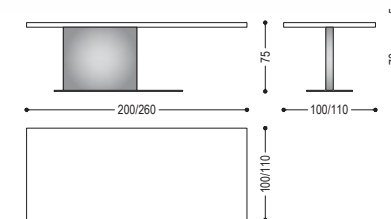

Tavolo con top realizzato in legno massello a liste incollate con lati squadrati, in abbinata ad una gamba asimmetrica posizionata lateralmente. Versione Iron: gamba e piastra a terra in ferro. Versione wood: gamba in legno massello e piastra a terra in ferro.

Qui: noce con nodi, finitura olio e base in ferro laccato colore irondust - rovere con nodi, finitura cera e base in ferro laccato colore irondust. A sinistra: rovere con nodi, finitura cera base in ferro laccato colore irondust. Nelle pagine successive: noce con nodi, finitura olio e base in ferro laccato colore irondust.

*Table with top in solid wood in glued lists and straight sides, combined with a base in iron composed of an asymmetrical leg. Iron model: leg and floor plate made of iron. Wood model: solid wood leg and iron floor plate.*

*On this page: walnut with knots, oil finish and iron base lacquered irondust - oak with knots, wax finish and iron base lacquered irondust. On the left: oak with knots, wax finish and iron base lacquered irondust. On the following pages: walnut with knots, oil finish and iron base lacquered irondust.*

*Tisch mit Platte bestehend aus verleimten Massivholzleisten, mit geraden Kanten. Asymmetrisches Gestell bestehend aus einem seitlich positioniertem Bein. Modell Iron: Fußbein und Bodenplatte aus Eisen. Modell Wood: Fußbein aus Massivholz und Bodenplatte aus Eisen.*

*Auf dieser Seite: Nussbaum mit Knoten geölt und Gestell lackiert irondust - Eiche mit Knoten gewachst und Gestell lackiert irondust. Links: Eiche mit Knoten gewachst und Gestell lackiert irondust. Auf den nächsten Seiten: Nussbaum mit Knoten geölt und Gestell lackiert irondust.*



LIGHT

MATTEO THUN



CM: L. 200/220/240/260/280/300 · P. 90/100 · H. 73

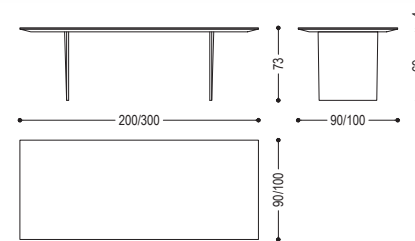

Per maggiori informazioni consultare il Pricelist  
For any further information please refer to the Pricelist  
Weitere Informationen entnehmen Sie bitte der Preisliste

Tavolo interamente realizzato in legno massello a liste incollate con lati squadri, che si caratterizza per gli spessori assottigliati del top e delle gambe. Versione con top di forma rettangolare.

Qui: noce senza nodi, finitura olio. Nella pagina destra: finitura rovere pigmentato total black.

*Table made entirely from solid wood glued lists having straight sides, characterised by thin edges on the top and the legs. Version with rectangular top.*

*On this page: walnut without knots, oil finish. On the right: total black pigmented finish.*

*Tisch völlig aus verleimten Massivholzleisten, mit geraden Kanten. Platte und Beine mit schrägen und dünnen Kanten. Variante mit rechteckiger Platte.*

*Im Foto: Nussbaum ohne Knoten geölt. Rechts: pigmentiert total black.*





## MESA

MOTOMI KAWAKAMI

Tavolo con top in legno massello a liste incollate con bordi stondati, abbinato ad un basamento dalle linee geometriche e rigorose che si esprime attraverso gambe in ferro con sezione trasversale a forma di T.

Qui e nella foto a sinistra: top noce con nodi, finitura olio e base in ferro laccato colore iron dust.

*Table with top in solid wood in glued lists and rounded edges, combined with a base with geometric, rigorous lines made of two legs with a T-shaped cross section.*

*In the pictures: top in walnut with knots, oil finish and iron base lacquered iron dust.*

*Tisch mit Platte bestehend aus verleimten Massivholzleisten mit abgerundeten Kanten. Das geometrische Gestell bestehend aus Eisen hat im Querschnitt ein T-förmiges Profil.*

*In den Fotos: Platte aus Nussbaum mit Knoten geölt und Gestell lackiert iron dust.*

CM: L. 200/220/240/260/280/300 · P. 100 · H. 74

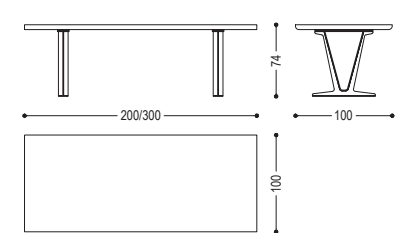

# NATURA

C.R.&S. RIVA1920



CM: L. 160/180/200 · P. 90 · H. 75  
CM: L. 200/220/240/260/280/300 · P. 100 · H. 75

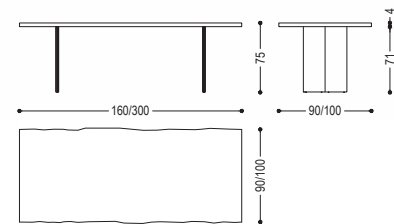

Per maggiori informazioni consultare il Pricelist  
For any further information please refer to the Pricelist  
Weitere Informationen entnehmen Sie bitte der Preisliste

Tavolo realizzato con top in legno massello a liste incollate, con bordi squadri o naturali in abbinata con gambe in ferro dotate di fuga centrale. Disponibile anche nella versione Plank con top realizzato in legno massello, composto da due tavole uniche con bordi naturali e fuga centrale.

Qui: top noce con nodi, finitura olio e base ferro laccato trasparente opaco - rovere con nodi, finitura cera e base ferro laccato Ral 1013. A destra e nelle pagine successive: top noce con nodi, finitura olio e base ferro laccato trasparente opaco.

*Table with solid wood top in glued lists, with natural or straight sides, in combination with iron legs having a central gap. Also available with top in two single planks with natural sides and middle gap.*

*On this page: top in walnut with knots, oil finish and natural iron base matt transparent lacquered - oak with knots, wax finish and iron base lacquered RAL 1013. On the following pages: top in walnut with knots, oil finish and natural iron base matt transparent lacquered.*

*Tisch mit Platte bestehend aus verleimten Massivholzleisten, mit Naturkanten. Gestell bestehend aus zwei Eisenwangen mit Mittelspalt. Auch in der Variante mit Platte bestehend aus zwei Planken mit Naturkanten und Mittelfuge.*

*Auf dieser Seite: Platte aus Nussbaum mit Knoten geölt und Gestell aus Natureisen matt transparent lackiert - Eiche mit Knoten gewachst und Gestell lackiert RAL 1013. Auf den nächsten Seiten: Platte aus Nussbaum mit Knoten geölt und Gestell aus Natureisen matt transparent lackiert.*







## NEWTON

C.R.&S. RIVA1920

Tavolo con top in legno massello a liste incollate con bordi naturali, in abbinata a gambe in ferro con saldature a vista. Disponibile anche nella versione Plank con top in legno massello, composto da due tavole uniche con bordi naturali e fuga centrale.

Qui: top noce senza nodi, finitura olio e base ferro naturale olio. A sinistra e nelle pagine successive: top rovere con nodi tabacco e base ferro naturale olio.

*Table with solid wood top in glued lists, with natural sides, in combination with iron legs with visible weld joints. Also available with top in two single planks with natural sides and middle gap.*

*On this page: top walnut with knots and natural iron base, oil finish. On the following pages: tabacco oak with knots and natural iron base, oil finish.*

*Tisch mit Platte bestehend aus verleimten Massivholzleisten, mit Naturkanten. Gestell aus Eisen mit sichtbaren Schweißnähten. Auch in der Variante mit Platte bestehend aus zwei Planken mit Naturkanten und Mittelfuge.*

*Auf dieser Seite: Platte aus Nussbaum mit Knoten und Gestell aus Natureisen, geölt. Auf den nächsten Seiten: Eiche mit Knoten Tabacco und Gestell aus Natureisen, geölt.*

CM: L. 160/180/200 · P. 90 · H. 75

CM: L. 200/220/240/260/280/300 · P. 100 · H. 75

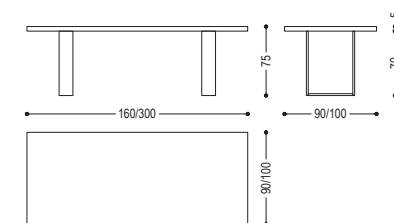

Per maggiori informazioni consultare il Pricelist  
For any further information please refer to the Pricelist  
Weitere Informationen entnehmen Sie bitte der Preisliste







## OMBRA TABLE

HIKARU MORI



Tavolo quadrato realizzato in legno massello, con gamba caratterizzata da due parallelepipedi scomposti e integrati tra loro, come un oggetto e la sua ombra. Unione di legno massello sciolto e una parte in ferro ricavata da una lamiera piegata. Piastra a pavimento in ferro. In alternativa elementi in ferro realizzabili con finitura effetto cemento. Disponibile anche nella versione rettangolare.

Qui e nella pagina destra: rovere con nodi, finitura cera e base in ferro laccato irondust.

*Square table in solid wood, with leg made of two parallelepipeds integrated with each other, like an object and its shadow. Union between solid wood in glued lists and a part made of a bended iron plate. Floor plate in iron. As an alternative, the iron parts can be produced in the concrete effect finish. Rectangular version also available.*

*In the pictures: oak with knots, wax finish and iron base lacquered irondust.*

*Quadratischer Tisch aus Massivholz, mit Bein bestehend aus zwei integrierten Quadern, wie ein Gegenstand und sein Schatten. Verbindung zwischen Massivholz, aus verleimten Leisten, und einem Teil aus Eisen. Bodenplatte aus Eisen. Als Alternative können die Eisenteile in Betonausführung sein. Rechteckige Variante auch erhältlich.*

*In den Fotos: Eiche mit Knoten gewachst und Gestell lackiert irondust.*

CM: L. 120/140/160 - P. 120/140/160 - H. 75

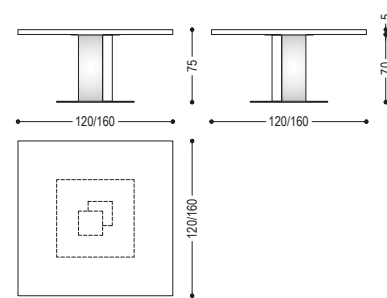

Per maggiori informazioni consultare il Pricelist  
For any further information please refer to the Pricelist  
Weitere Informationen entnehmen Sie bitte der Preisliste

## PANDANUS

JAMIE DURIE

Tavolo tondo interamente realizzato in legno massello con top a liste incollate e gamba centrale tornita in cedro finitura vulcano. Disponibile anche con piano in marmo.

Qui: top in Marmo Emperador Dark e gamba in cedro vulcano - top in noce con nodi, finitura olio e gamba in cedro vulcano. Nella pagina destra: top in noce con nodi, finitura olio e gamba in cedro vulcano.

*Round table made entirely of solid wood, with top in glued lists and central turned leg in vulcano cedar. Also available with marble top.*

*On this page: Emperador Dark marble top and leg in vulcano cedar - top in walnut with knots, oil finish and leg in vulcano cedar. On the right: top in walnut with knots, oil finish and leg in vulcano cedar.*

*Tisch mit runder Platte bestehend aus verleimten Massivholzleisten und mittlerem gedrechseltem Bein aus Zeder, Vulcano Ausführung. Auch mit Platte aus Marmor erhältlich.*

*Im Foto: Emperador Dark Marmorplatte und Bein aus Zeder, Vulcano Ausführung - Platte aus Nussbaum mit Knoten geölt und Bein aus Zeder, Vulcano Ausführung. Rechts: Platte aus Nussbaum mit Knoten geölt und Bein aus Zeder, Vulcano Ausführung.*

CM: Ø 140/160/180 · H. 75

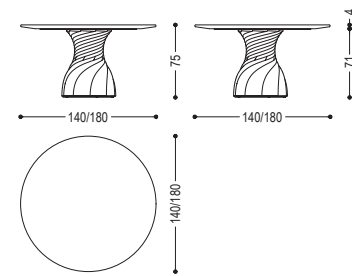

Per maggiori informazioni consultare il Pricelist  
For any further information please refer to the Pricelist  
Weitere Informationen entnehmen Sie bitte der Preisliste





## PARLA BIG & SMALL

KARSTEN SCHMIDT-HOENSDORF



Tavolo snack rotondo, interamente realizzato in legno massello con top a liste incollate, caratterizzato da un basamento a raggiata funzionale come poggiatesta. Disponibile in due diametri e in due diverse altezze. Qui: top e struttura in noce con nodi, finitura olio. Nella pagina sinistra: top e struttura in rovere con nodi, finitura cera.

Round snack table, made entirely of solid wood with top in glued lts, characterised by a radial base that can be used as a footrest. Available in two different diameters and two different heights.

On this page: top and base in walnut, oil finish. On the left: top and base in oak with knots, wax finish.

Stehetisch mit runder Platte bestehend aus verleimten Massivholzleisten. Gestell strahlenförmig aufgebaut, als Fussstutz geeignet. In zwei verschiedenen Durchmessern und zwei verschiedenen Höhen erhältlich. Auf dieser Seite: Platte und Gestell aus Nussbaum mit Knoten geölt. Links: Platte und Gestell aus Eiche mit Knoten gewachst.

PARLA BIG  
CM: Ø. 80 · H. 113

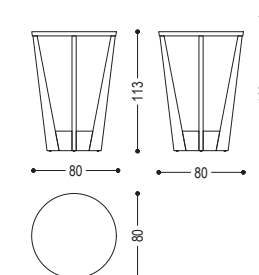

PARLA SMALL  
CM: Ø. 80 · H. 108

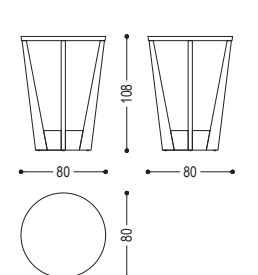

## PRIME WOOD EXTENDIBLE

C.R.&S. RIVA1920

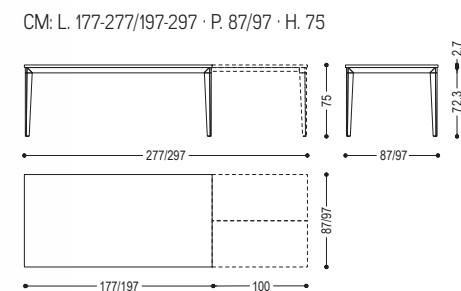

Tavolo allungabile con top realizzato in legno massello a liste incollate con lati squadrati e base in ferro. La versione allungabile si distingue per un innovativo e tecnologico sistema, con binari in alluminio perfettamente integrati nella struttura a garantire una prolunga di 100 cm.

Qui, a destra e nelle pagine successive: top noce con nodi, finitura olio e base ferro laccato irondust.

*Extendable table with top made of solid wood in glued lists, with straight sides and base in iron. The extendable version stands out for an innovative and technological system, with an aluminium frame equipped with sliding device perfectly integrated in the structure that allows an extension of 100 cm.*

*In the pictures: top in walnut with knots, oil finish and iron base lacquered irondust.*

*Ausziehtisch mit Platte bestehend aus verleimten Massivholzleisten, mit geraden Kanten. Gestell aus Eisen. Mit integriertem Mechanismus aus Aluminium und Auszugsplatte aus Holz 100 cm lang.*

*In den Fotos: Platte aus Nussbaum mit Knoten geölt und Gestell lackiert irondust.*

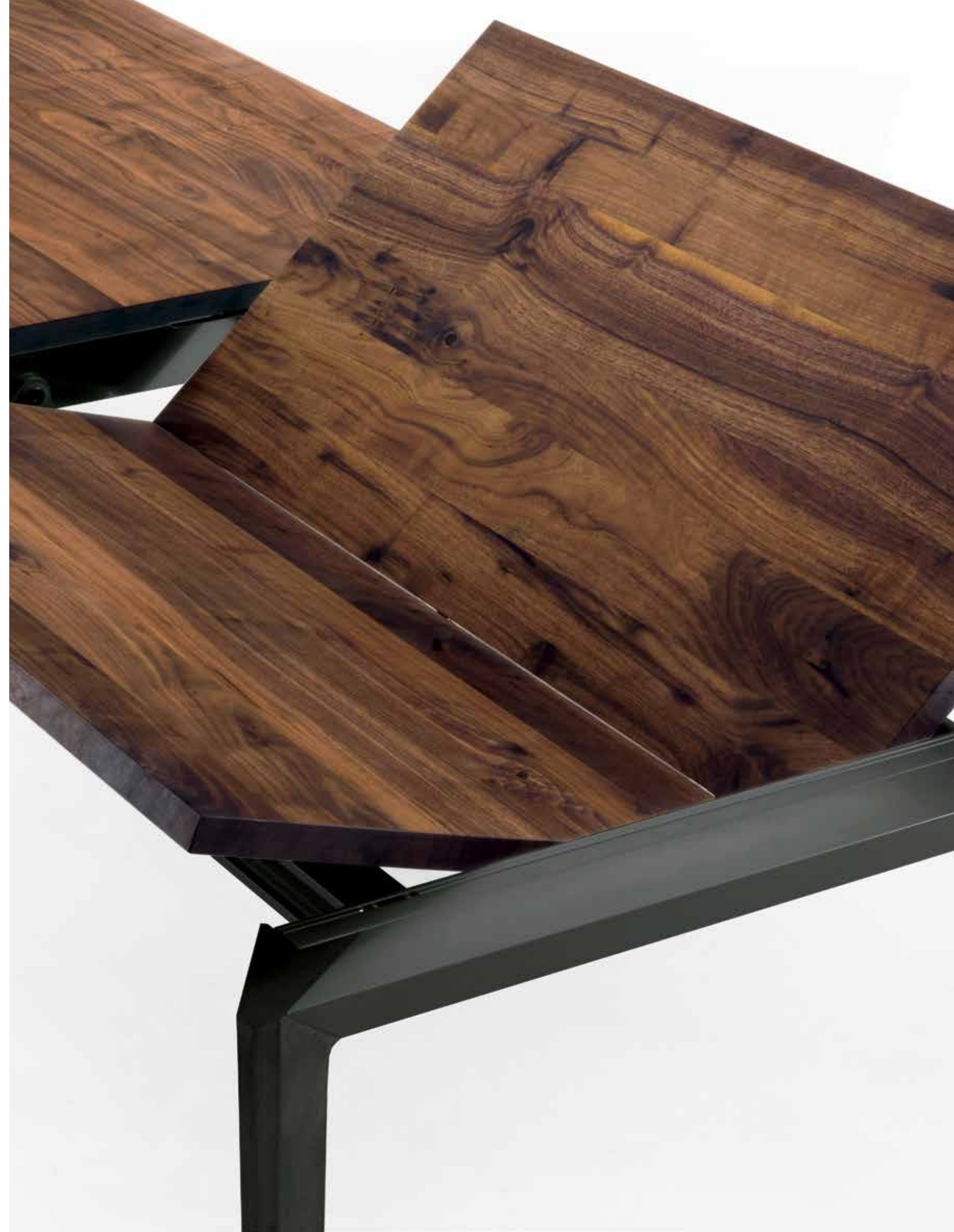



## PRIME WOOD FIX

C.R.&S. RIVA1920



CM: L. 180/200/220/240 · P. 100 · H. 75

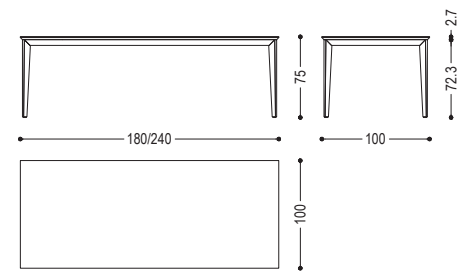

Tavolo allungabile con top realizzato in legno massello a liste incollate con lati squadrati e base in ferro.

Qui e nella pagina destra: top noce con nodi, finitura olio e base ferro laccato irondust.

*Extendable table with top made of solid wood in glued lists, with straight sides and base in iron.*

*In the pictures: top in walnut with knots, oil finish and iron base lacquered irondust.*

*Ausziehtisch mit Platte bestehend aus verleimten Massivholzleisten, mit geraden Kanten. Gestell aus Eisen.*

*In den Fotos: Platte aus Nussbaum mit Knoten geölt und Gestell lackiert irondust.*



## SHANG

GIULIANO & GABRIELE CAPPELLETTI

Tavolo tondo realizzato con top in listellare con bordatura in massello e possibilità di aggiunta di un inserto centrale in legno oppure marmo, dotato di sistema girevole Lazy Susan. Il basamento, composto da listelli in legno massello, richiama il simbolo dell'infinito. Disponibile anche nella versione con top in marmo.

Qui e nella pagina sinistra: top noce con nodi, finitura olio e Gres Sahara Noir; basamento in noce, finitura olio.

*Round table with top in veneered blockboard and edges in solid wood, with the possibility to add a middle insert in wood or marble, equipped with rotating system Lazy Susan. The base, made of solid wood lists, represents the infinity symbol. Also available with marble top.*

*In the pictures: top in walnut with knots, oil finish and Stoneware Sahara Noir; base in walnut, oil finish.*

*Runder Tisch mit Platte aus Tischlerplatte mit Massivholzkanten mit der Möglichkeit, in der Mitte einen Drehteller Lazy Susan aus Holz oder Marmor zu haben. Das Gestell, bestehend aus Massivholzleisten, symbolisiert das Unendlichzeichen. Auch in der Variante mit Platte aus Marmor erhältlich.*

*In den Fotos: Platte aus Nussbaum mit Knoten geölt und Feinsteinzeug Sahara Noir; Gestell aus Nussbaum geölt.*

CM: Ø. 180/220/240 · H. 75,3

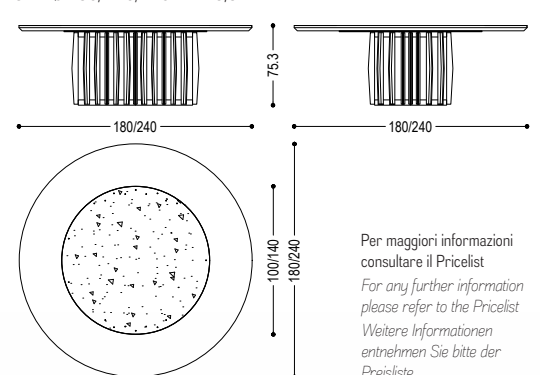

## SKY-NATURA

C.R.&S. RIVA1920



CM: L. 160/180/200 · P. 90 · H. 75  
CM: L. 200/220/240/260/280/300 · P. 100 · H. 75

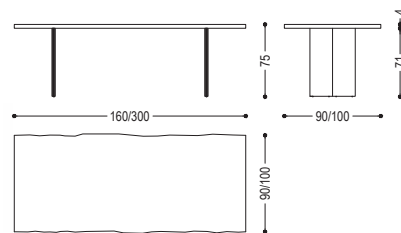

Per maggiori informazioni consultare il Pricelist  
For any further information please refer to the Pricelist  
Weitere Informationen entnehmen Sie bitte der Preisliste

Tavolo realizzato con top in legno massello a liste incollate, con bordi squadri o naturali in abbinata di gambe in ferro caratterizzate da una doppia lamina semi-piegata dalla forma a rombo.

Qui, a destra e nelle pagine successive: top noce con nodi, finitura olio e base ferro laccato trasparente opaco.

*Table with solid wood top in glued lists, with straight or natural sides, in combination with iron legs characterised by double sheet metal semi-folded in the shape of a rhombus.*

*In the pictures: top in walnut with knots, oil finish and natural iron base matt transparent lacquered.*

*Tisch mit Platte bestehend aus verleimten Massivholzleisten, mit geraden oder Naturkanten. Gestell aus Eisen in charakteristischer Rautenform.*

*In den Fotos: Platte aus Nussbaum mit Knoten geölt und Gestell aus Natureisen matt transparent lackiert.*





SLEEK

KARIM RASHID



CM: L. 180/200/220 · P. 90 · H. 72,5  
CM: L. 180/200/220 · P. 100 · H. 72,5

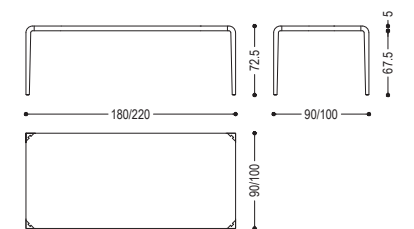

Tavolo interamente realizzato in legno massello con top a liste incollate sul quale, mediante un particolare sistema a coda di rondine, si incastrano le quattro gambe.

Qui e a sinistra: finitura noce senza nodi, finitura olio. Nelle pagine successive: rovere senza nodi, finitura cera.

*Table made entirely in solid wood with top in glued lists to which, by means of a particular dovetail system, the four legs are fixed.  
In these pictures: walnut without knots, oil finish. On the following pages: oak without knots, wax finish.*

*Tisch völlig aus Massivholz gefertigt, mit Platte aus verleimten Leisten. Besondere Schwalbenschwanzverbindungen zwischen der Platte und den vier Beinen.*

*Auf diesen Seiten: Nussbaum mit Knoten geölt. Auf den nächsten Seiten: Eiche ohne Knoten gewachst.*



## FRAME · FRAME RESIN

C.R.&S. RIVA1920

Console interamente realizzata in legno massello a liste incollate con lati squadri, caratterizzata da un incastro a coda di rondine tra top e base. Disponibile anche nella versione Resin: composta da tavole uniche con bordi naturali; nella parte centrale si trova un'elegante striscia di resina trasparente.

Qui: noce con nodi, finitura olio e inserto in resina - rovere senza nodi, finitura cera. Nella pagina destra: noce con nodi, finitura olio e inserto in resina.

*Console made entirely of solid wood in glued lists, with straight sides, characterized by a dovetail joint between the top and the legs. Also available with resin: consisting of planks characterized by natural sides in the middle space, which is filled with transparent resin.*

*On this page: walnut with knots, oil finish and transparent resin - oak without knots, wax finish. On the right: walnut with knots, oil finish and transparent resin.*

*Konsole völlig aus Massivholz gefertigt, mit geraden Kanten und Schwalbenschwanzverbindung zwischen Platte und Gestell. Auch in der Variante mit Kunstharz erhältlich: bestehend aus Planken mit Naturkanten sichtbar in der mittleren Fuge, die mit transparentem Kunstharz ausgefüllt ist. Auf dieser Seite: Nussbaum mit Knoten geölt und transparentes Kunstharz - Eiche mit Knoten gewachst. Rechts: Nussbaum mit Knoten geölt und transparentes Kunstharz.*

### FRAME

CM: L. 180/200/220/240/260 · P. 35 · H. 85

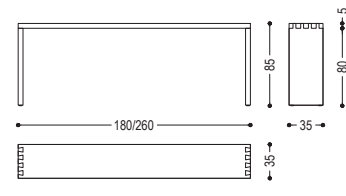

### FRAME RESIN

CM: L. 165/180/195 · P. 49.5 · H.85

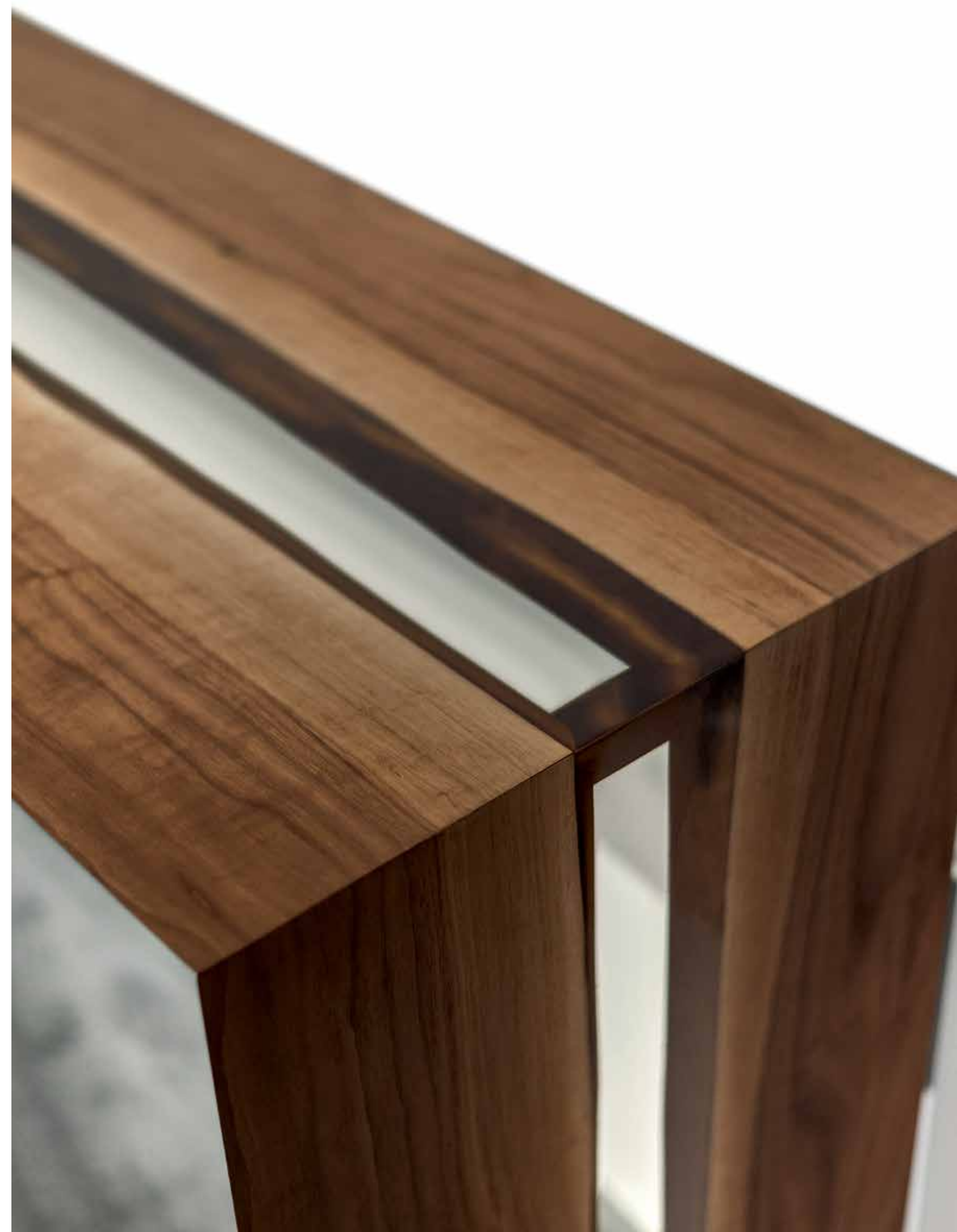
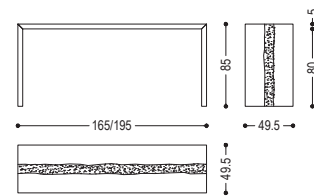

## FRAME BAR

C.R.&S. RIVA1920



CM: L. 210/230/250 · P. 35 · H. 108

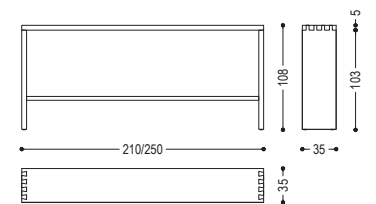

Console interamente realizzata in legno massello a liste incollate con lati squadrati, caratterizzata da un incastro a coda di rondine tra top e base, dotata di barra metallica poggiapiedi.

Qui e nella pagina sinistra: noce con nodi, finitura olio.

*Console made entirely of solid wood in glued lists, with straight sides, characterized by a dovetail joint between the top and the legs. Equipped with a metal bar to be used as footrest.*

*In the pictures: walnut with knots, oil finish.*

*Konsole völlig aus Massivholz gefertigt, mit geraden Kanten und Schwalbenschwanzverbindung zwischen Platte und Gestell. Fußstütze aus Metall.*

*In den Fotos: Nussbaum mit Knoten geölt.*



TAVOLINI · SMALL TABLES · COUCHTISCHE



**BUNGALOW SIDE TABLE** 106-107



**KOHI** 108-109



**SUSY** 110-111



**TAO** 112-113



**YIN & YANG COFFEE TABLE** 114-115





## BUNGALOW SIDE TABLE

JAMIE DURIE

Tavolino composto da struttura in legno massello completamente tornita, assemblata e levigata a mano, abbinata ad un top in marmo incassato.

Qui e nella pagina sinistra: struttura teak, finitura olio e top marmo Emperador Dark.

*Side table with structure made of solid wood, turned, assembled and sanded completely by hand, combined with a recessed marble top.  
In the pictures: structure in teak, oil finish, and Emperador Dark marble top.*

*Couchtisch mit Gestell aus Massiv, von Hand gedrechselt, aufgebaut und geschliffen, und eingelassener Marmorplatte.  
In den Fotos: Gestell aus Teak geölt und Emperador Dark Marmorplatte.*

CM. L. 85 · P.82 · H. 45

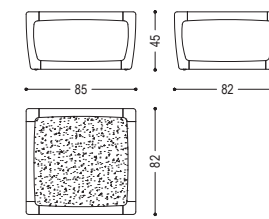



## KOHI

TERRY DWAN

Tavolini rotondi realizzati con top in legno massello a liste incollate o in marmo abbinato ad una base in ferro. Disponibili in diverse altezze e dimensioni, con possibilità di essere inseriti l'uno sotto l'altro.

Qui: top noce con nodi, finitura olio - marmo Emperador Dark, base ferro laccato irondust. Nella pagina sinistra: top rovere senza nodi pigmentato total black - noce con nodi, finitura olio e base ferro laccato effetto rame antico spazzolato opaco.

*Round small table with top made entirely of solid wood or marble, combined with an iron base. Available in different sizes, with possibility of stacking one over the other.*

*On this page: top in walnut with knots, oil finish - Emperador Dark marble, iron base lacquered irondust. On the left: top in total black pigmented oak without knots - walnut with knots, oil finish, and iron base lacquered aged copper matt brushed effect.*

*Runde Couchtische mit Platte aus Massivholz oder aus Marmor und Gestell aus Eisen, in verschiedenen Maßen erhältlich. Sie können ineinander geschoben werden.*

*Auf dieser Seite: Platte aus Nussbaum mit Knoten geölt - Marmor Emperador Dark, Gestell lackiert irondust. Links: Platte aus Eiche ohne Knoten pigmentiert total black - Nussbaum mit Knoten geölt und Gestell lackiert Kupfer-Effekt matt gebürstet.*

KOHI-WOOD1

CM: Ø 65 · H. 22

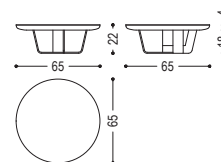

KOHI-WOOD2

CM: Ø 65 · H. 32

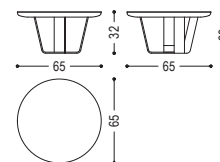

KOHI-WOOD3

CM: Ø 95 · H. 22

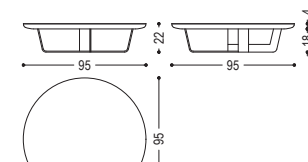

KOHI-WOOD4

CM: Ø 95 · H. 32

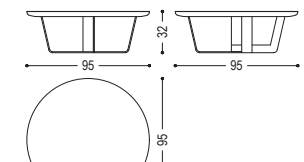

KOHI-MARBLE1

CM: Ø 65 · H. 21,5

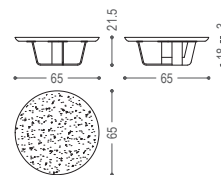

KOHI-MARBLE2

CM: Ø 65 · H. 31,5

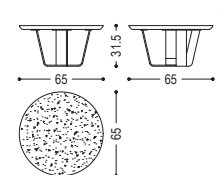

KOHI-MARBLE3

CM: Ø 95 · H. 21,5

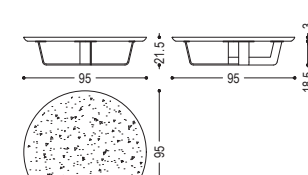

KOHI-MARBLE4

CM: Ø 95 · H. 31,5

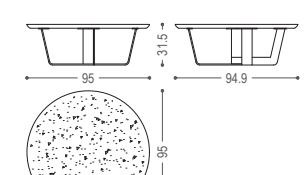





SUSY

MATTEO THUN



SUSY 1

CM: L. 38-41,2 · P. 38-42,5 · H. 42

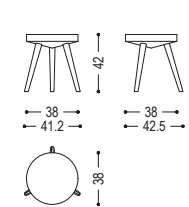

SUSY 2

CM: L. 38-41,2 · P. 38-42,5 · H. 51

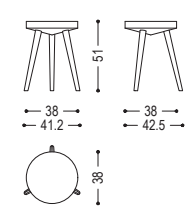

Tavolino tondo in legno massello caratterizzato da un top spesso e da tre gambe d'appoggio.

Qui e nella pagina sinistra: noce senza nodi, finitura olio.

*Round small table in solid wood characterized by a thick top and three legs.*

*In the pictures: walnut without knots, oil finish.*

*Runder Beistelltisch völlig aus Massivholz, bestehend aus einer dicken Tischplatte und drei Beinen.*

*In den Fotos: Nussbaum ohne Knoten geölt.*

TAO

C.R.&S. RIVA1920



TAO SMALL

CM: Ø. 40 · H. 34

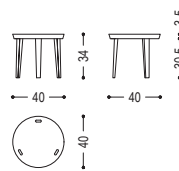

TAO 50

CM: Ø. 50 · H. 39

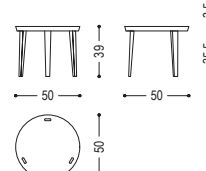

TAO BIG

CM: Ø. 60 · H. 44

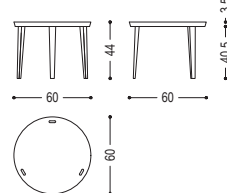

Serie di tavolini interamente realizzati in legno massello disponibili in differenti diametri e altezze con possibilità di essere riposti l'uno sotto l'altro. Le gambe sono a vista sul top. Qui e nella pagina destra: noce con nodi, finitura olio.

*Series of small tables made of solid wood, available in various diameters and heights, with possibility of stacking one over the other. The legs pass through the top and are visible on the surface.*

*In the pictures: walnut with knots, oil finish.*

*3 Satz-Couchtischen in verschiedenen Durchmesser und Höhen erhältlich und völlig aus Massivholz gefertigt. Sie können ineinander geschoben werden. Die Beine sind durch die Platte durchstossend und auf der Oberfläche sichtbar.*

*In den Fotos: Nussbaum mit Knoten geölt.*

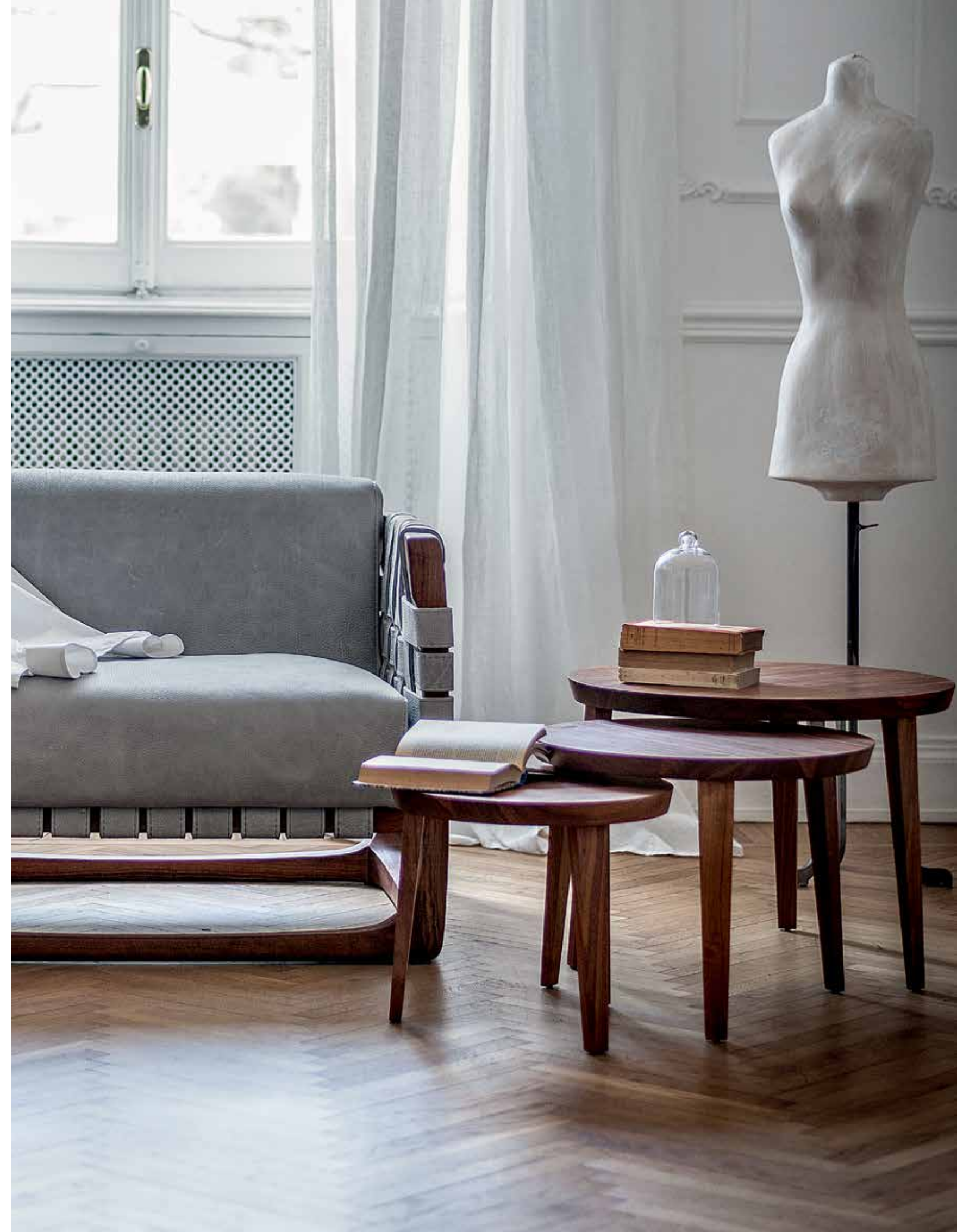



## YIN & YANG COFFEE TABLE

STEVE LEUNG



CM. Ø. 120 · H. 35

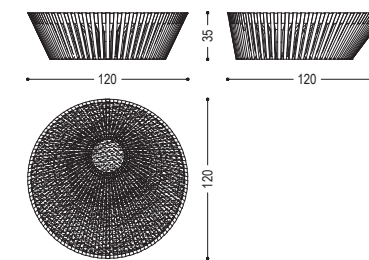

Tavolino dalla forma ellittica, caratterizzato da una serie di elementi in legno massello sagomati e posizionati a raggera che accolgono un top in cristallo trasparente.

Qui e nella pagina sinistra: noce senza nodi, finitura olio.

*Oval side table, made of a series of molded solid wood elements positioned as a fan, which supports a clear glass top.*

*In the pictures: walnut without knots, oil finish.*

*Ovaler Couchtisch bestehend aus einer Reihe von Massivholzstücken, strahlenförmig zusammengestellt, die eine Klarglasplatte stützen.*

*In den Fotos: Nussbaum ohne Knoten geölt.*



SEDIE · CHAIRS · STÜHLE



ARM CHAIR METAL 118-119



ARM CHAIR WOOD  
ARM CHAIR WOOD EVOLUTION 120-121



BUNGALOW DINING CHAIR 122-123



CLOE - CLOE ARM 124-125



KAU 126-127



MATERIA 128-129



MATERIA SOFT  
MATERIA SOFT ARM 130-131



MIA 132-133



NOBLÉ CHAIR · NOBLÉ CHAIR.1 134-35



PIANO DESIGN CHAIR 136-137



PIMPINELLA 138-139



SLEEK 140-141



VOLTRI 142-143



## ARM CHAIR METAL

C.R.&S. RIVA1920

Poltroncina elegante ed avvolgente, con gambe in ferro. Scocca in poliuretano espanso in linea di continuità tra schienale e braccioli, dotata di morbido cuscino d'appoggio integrato nella seduta. Disponibile anche in versione girevole.

Qui: tessuto Divina Melange 2-170, gambe ferro laccato irondust. Nella pagina sinistra: pelle Camoscio 26, gambe ferro laccato irondust.

*Elegant and enveloping armchair with iron legs. Expanded polyurethane structure in a continuous line between the back and the armrests. Soft cushion integrated in the seat. Also available with revolving base.*

*On this page: fabric Divina Melange 2-170, iron legs lacquered irondust. On the left: leather Camoscio 26, iron legs lacquered irondust.*

*Eleganter und umhüllender Armlehnstuhl mit Gestell aus Eisen. Struktur aus Polyurethanschaum, mit weichem Sitzpolster aus Leder oder Stoff bezogen. Auch mit drehbarem Gestell erhältlich.*

*Auf dieser Seite: Stoff Divina Melange 2-170, Eisengestell lackiert irondust. Links: Leder Camoscio 26, Eisengestell lackiert irondust.*

CM: L. 63 · P. 58 · H. 47/81,5

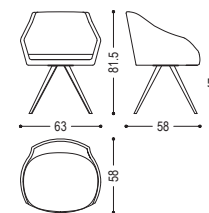

## ARM CHAIR WOOD · ARM CHAIR WOOD EVOLUTION

C.R.&S. RIVA1920



Poltroncina elegante ed avvolgente, con gambe in legno. Scocca in poliuretano espanso in linea di continuità tra schienale e braccioli, dotata di morbido cuscino d'appoggio integrato nella seduta. Disponibile anche in versione girevole.

Qui e destra: base noce senza nodi, finitura olio e pelle Camoscio 27.

*Elegant and enveloping armchair with wooden legs. Expanded polyurethane structure in a continuous line between the back and the armrests. Soft cushion integrated in the seat. Also available with revolving base. In the pictures: base in walnut without knots, oil finish, and leather Camoscio 27.*

*Eleganter und umhüllender Armlehnstuhl mit Gestell aus Holz. Struktur aus Polyurethanschaum, mit weichem Sitzpolster aus Leder oder Stoff bezogen. Auch mit drehbarem Gestell erhältlich.*

*In den Fotos: Gestell aus Nussbaum ohne Knoten geölt und Leder Camoscio 27.*

ARM CHAIR-WOOD

ARM CHAIR-WOOD EVOLUTION

CM: L. 63 · P. 58 · H. 47/81,5

CM: L. 63 · P. 58 · H. 47/81,5

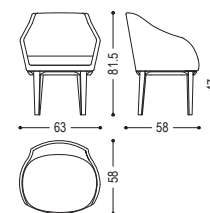
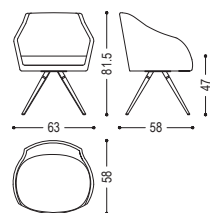

## BUNGALOW DINING CHAIR

JAMIE DURIE



Sedia imbottita con struttura realizzata in legno massello completamente tornita, assemblata e levigata a mano. Un intreccio di stringhe in pelle o tessuto caratterizza la seduta, che si distingue per il grande comfort. Nella versione in tessuto previsto rinforzo strutturale all'interno del rivestimento.

Qui e nella pagina destra: noce senza nodi, finitura olio e pelle Utah 102.

*Padded chair with structure in solid wood turned, assembled and sanded completely by hand. An original detail are the strips of leather or fabric running both under the seat, on the backrest and on the armrests. When in fabric these strips have a structural support inside.*

*In the pictures: walnut without knots, oil finish, and leather Utah 102.*

*Gepolsterter Stuhl mit Gestell aus Massivholz, von Hand gedreht, aufgebaut und geschliffen. Besonderes Detail sind die Streifen in Leder oder Stoff unter dem Sitz, auf der Rückenlehne und auf den Armlehnen.*

*Bei der Variante in Stoff sind diese Streifen innen strukturell verstärkt. In den Fotos: Nussbaum ohne Knoten geölt und Leder Utah 102.*

CM: L. 64,5 · P. 56 · H. 45,5/80

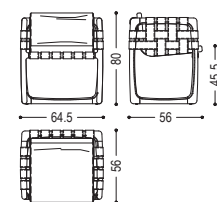



## CLOE · CLOE ARM

C.R.&S. RIVA1920

Elegante sedia con gambe in legno massello e scocca in poliuretano espanso in linea di continuità con seduta e schienale. Versione con e senza braccioli, con rivestimento in pelle o tessuto con retro schienale con cuciture a rombi o liscio.

Qui: noce senza nodi, finitura olio e velluto Harald 792. Nella pagina sinistra: noce senza nodi, finitura olio e velluto Harald 582.

*Elegant chair with legs in solid wood and structure made of polyurethane with back and seat in continuous line. Available with or without armrests, with cover in leather or fabric; the back of the chair cover can be plain or with rhombus stitching.*

*On this page: walnut without knots, oil finish, and velvet Harald 792. On the left: walnut without knots, oil finish, and velvet Harald 582.*

*Eleganter Stuhl mit Beinen aus Massivholz, Sitz und Rückenlehne aus Polyurethanschaum. Mit oder ohne Armlehne, mit Leder- oder Stoffbezug. Die Rückseite des Bezugs kann glatt oder mit Rautennähten sein.*

*Auf dieser Seite: Nussbaum ohne Knoten geölt und Samt Harald 792. Links: Nussbaum ohne Knoten geölt und Samt Harald 582.*



CLOE

CM: L. 53 · P. 59 · H. 48,5/85,5

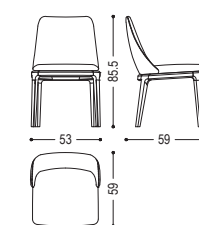

CLOE ARM

CM: L. 53 · P. 59 · H. 48,5/85,5

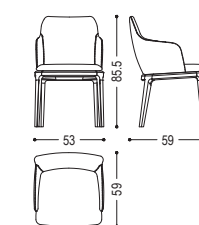



KAU

CLAUDIO BELLINI



Sedia con struttura in metallo completamente rivestita in cuoietto o tessuto cucito a mano.  
Qui: rivestimento cuoio Olimpia 017.  
Nella pagina destra: rivestimento tessuto Maple 742.

CM: L. 50 · P. 48 · H. 46/78,5

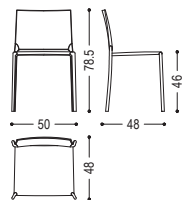

*Chair with metal structure completely covered in decorated and hand-sewn hide leather or fabric.  
On this page: leather Olimpia 017. On the right: fabric Maple 742.*

*Stuhl mit Metallstruktur, völlig aus Kernleder oder Stoff bezogen, per Hand genäht.  
Auf dieser Seite: Leder Olimpia 017. Rechts: Stoff Maple 742.*





## MATERIA

CLAUDIO BELLINI



Sedia con scocca avvolgente realizzata in legno massello con schienale e seduta unite tra loro attraverso una scenografica giunzione a coda di rondine. Dotata di base girevole in alluminio.

Qui e nella pagina sinistra: noce senza nodi, finitura olio e base laccata iron dust.

*Enveloping chair completely in solid wood, with seat and back combined through dovetail joints. Revolving aluminium base.*

*In the pictures: walnut without knots, oil finish, and base lacquered iron dust.*

*Bequemer Stuhl völlig aus Massivholz. Sitzfläche und Rückenlehne mit traditioneller Schwalbenschwanzverbindung. Mit drehbarem Aluminiumgestell.*

*In den Fotos: Nussbaum ohne Knoten geölt und Gestell lackiert iron dust.*

CM: L. 46 · P. 56 · H. 45/80,5

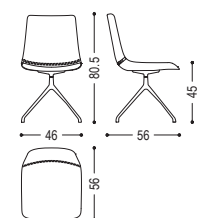

## MATERIA SOFT · MATERIA SOFT ARM

CLAUDIO BELLINI



Sedia con scocca avvolgente realizzata in poliuretano con schienale e seduta rivestiti in pelle o tessuto con cuciture a vista. Dotata di base girevole in alluminio. Disponibile con e senza braccioli.

Qui: rivestimento pelle Nabuk 104 e base laccata irondust. Nella pagina destra: rivestimento pelle Nabuk 104 e base ferro laccato effetto bronzo antico spazzolato opaco.

*Chair with enveloping structure made of polyurethane, backrest and seat covered with leather or fabric with visible stitching. Revolving aluminium base. Available with or without armrests.*

*On this page: leather Nabuk 104 and base lacquered irondust. On the right: leather Nabuk 104 and base lacquered aged bronze matt brushed effect.*

*Bequemer Stuhl mit Struktur aus Polyurethanschaum. Sitzfläche und Rückenlehne mit Bezug aus Leder oder Stoff mit dekorativen Nähten. Mit drehbarem Aluminiumgestell. Mit oder ohne Armlehnen erhältlich.*

*Auf dieser Seite: Leder Nabuk 104 und Gestell lackiert irondust. Rechts: Leder Nabuk 104 und Gestell lackiert Bronze-Effekt matt gebürstet.*

MATERIA SOFT  
CM: L. 46 · P. 53 · H. 46/83

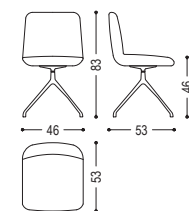

MATERIA SOFT ARM  
CM: L. 55 · P. 53 · H. 46/83

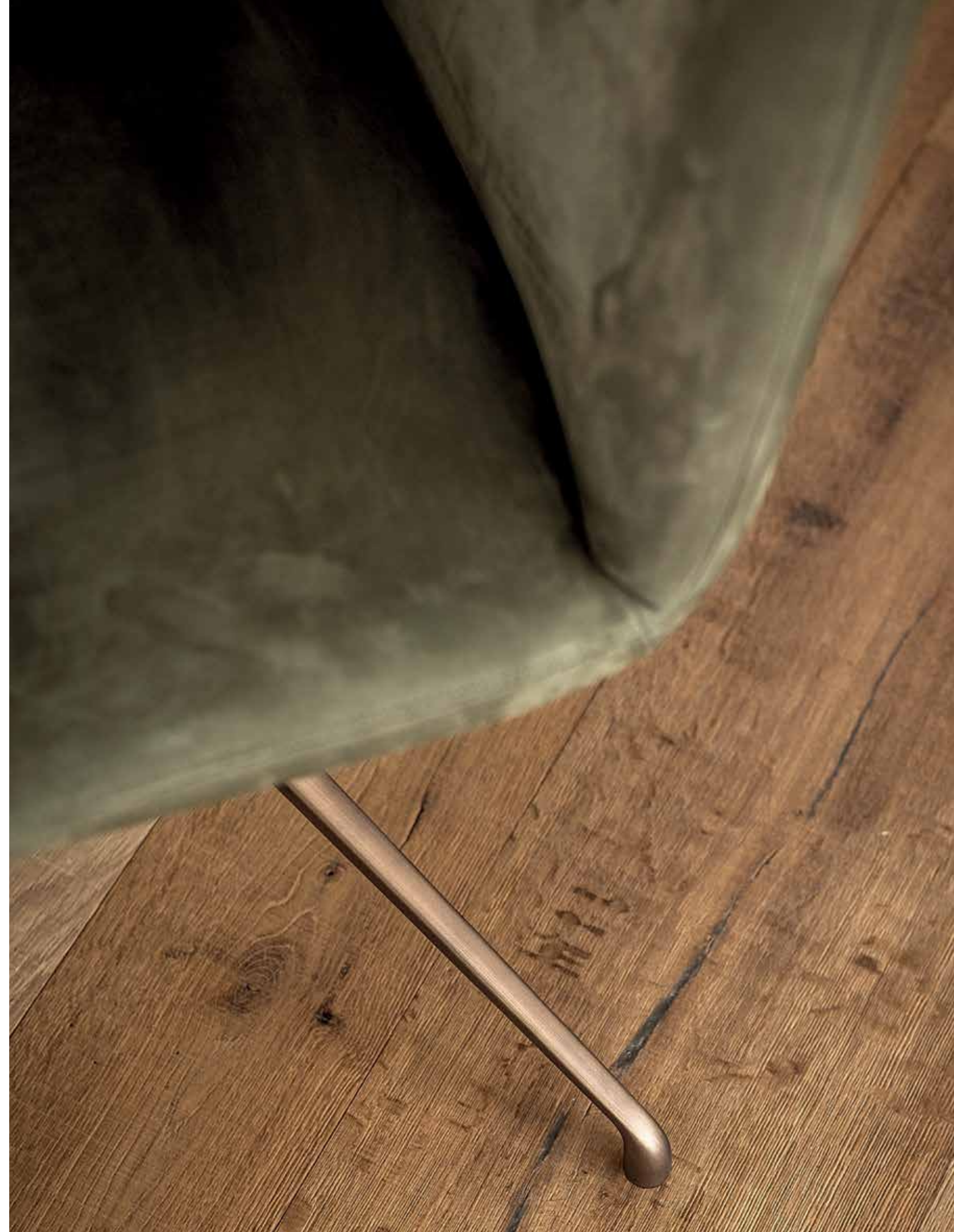
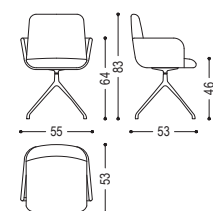



## MIA

C.R.&S. RIVA1920



Sedia realizzata totalmente in legno massello. Disponibile in tre varianti: seduta legno, seduta imbottita e incassata, seduta con cuscino da appoggio.

Qui e nella pagina sinistra: rovere senza nodi, finitura cera.

*Chair entirely made of solid wood. Three models available: wooden seat, padded and built-in seat and seat with decorative cushion.*

*In the pictures: oak without knots, wax finish.*

*Stuhl völlig aus Massivholz. In drei Varianten erhältlich: Sitzfläche aus Holz, fest integriertem gepolstertem Sitzkissen mit Lederbezug, oder mit Dekokissen.*

*In den Fotos: Eiche ohne Knoten gewachst.*

MIA WOOD  
CM: L. 49,5 · P. 48 · H. 46/80

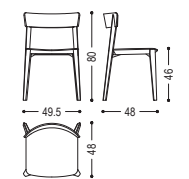

MIA LEATHER  
CM: L. 49,5 · P. 48 · H. 47,5/80

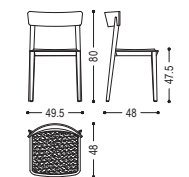

## NOBLÉ CHAIR · NOBLÉ CHAIR.1

GIULIANO & GABRIELE CAPPELLETTI

Sedia caratterizzata da scocca in poliuretano, dotata di schienale e comoda seduta schiumati e rivestiti in pelle o tessuto con cuciture a vista. I braccioli in legno massello, disponibili in due versioni (H. 53 cm oppure H. 64 cm), formano una linea di continuità con le gambe.

Qui: rovere senza nodi, finitura cera e pelle Camoscio 31 - noce senza nodi, finitura olio e pelle Camoscio 26. Nella pagina destra: rovere senza nodi, finitura cera e pelle Camoscio 31.

*Chair characterized by a polyurethane structure, with back and comfortable foamed seat upholstered in leather or fabric, with visible stitching. The solid wood armrests, available in two versions (H. 53 cm or H.64 cm) form a unique line with the legs.*

*On this page: oak without knots, wax finish, and leather Camoscio 31 – walnut without knots, oil finish, and leather Camoscio 26. On the right: oak without knots, wax finish, and leather Camoscio 31.*

*Stuhl Struktur aus Polyurethanschaum, mit Rückenlehne und bequemem gepolsterem Sitz. Bezug aus Leder oder Stoff mit dekorativen Nähten. Die Armlehnen sind aus Massivholz, in zwei Varianten (H. 53 cm oder H. 64 cm) erhältlich.*

*Auf dieser Seite: Eiche ohne Knoten gewachst und Leder Camoscio 31 - Nussbaum ohne Knoten geölt und Leder Camoscio 26. Rechts: Eiche ohne Knoten gewachst und Leder Camoscio 31.*



NOBLÉ CHAIR  
CM: L. 53 · P. 53 · H. 46/80

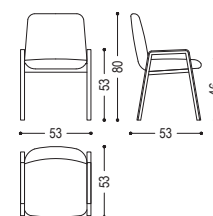

NOBLÉ CHAIR.1  
CM: L. 53 · P. 53 · H. 46/80

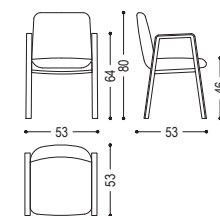



## PIANO DESIGN CHAIR

RENZO & MATTEO PIANO



CM: L. 39 · P. 48,5 · H. 43,5/83

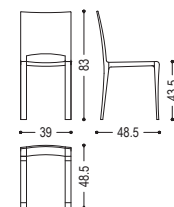

Sedia realizzata totalmente in legno massello.  
Qui: noce senza nodi, finitura olio. Nella pagina  
sinistra: ciliegio, finitura olio.

*Chair entirely made of solid wood.  
On this page: walnut without knots, oil finish. On  
the left: cherry, oil finish.*

*Stuhl völlig aus Massivholz gefertigt.  
Auf dieser Seite: Nussbaum ohne Knoten geölt.  
Links: Kirschbaum geölt.*

## PIMPINELLA

RICCARDO ARBIZZONI



PIMPINELLA WOOD  
CM: L. 45,5 · P. 51 · H. 45/83,5

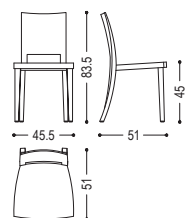

PIMPINELLA LEATHER/FABRIC  
CM: L. 47 · P. 51 · H. 49/83,5

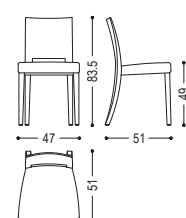

Sedia realizzata in legno massello, disponibile nella versione "total wood" oppure con seduta imbottita rivestita in pelle o in tessuto.  
Qui e nella pagina destra: noce senza nodi, finitura olio e pelle Utah 106 - tessuto Divina Melange 2-170.

*Chair entirely made of solid wood. Available in the "total wood" model or with padded seat covered in leather or fabric.  
In the pictures: walnut without knots, oil finish, and leather Utah 106 - fabric Divina Melange 2-170.*

*Stuhl völlig aus Massivholz. Er ist in 2 Varianten erhältlich: mit Sitzfläche aus Holz oder mit Sitzpolster aus Leder oder Stoff bezogen.  
In den Fotos: Nussbaum ohne Knoten geölt und Leder Utah 106 - Stoff Divina Melange 2-170.*





## SLEEK

KARIM RASHID

Sedia realizzata totalmente in legno massello, dotata di grande leggerezza.  
Qui e nella pagina sinistra: noce senza nodi, finitura olio.

*Chair entirely made of solid wood, characterized by the lightness of its structure.  
In the pictures: walnut without knots, oil finish.*

*Stuhl völlig aus Massivholz, mit leichter Struktur.  
In den Fotos: Nussbaum ohne Knoten geölt.*

CM: L. 44,5 · P. 46 · H. 45/78

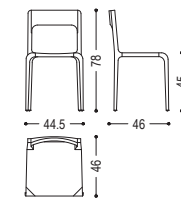





## VOLTRI

RENZO & MATTEO PIANO



Sedia realizzata totalmente in legno massello, si differenzia dal modello Piano Design Chair per lo schienale abbassato e una seduta più ampia. Qui: rovere pigmentato total black - noce senza nodi, finitura olio. Nella pagina sinistra: noce senza nodi, finitura olio.

*Chair entirely made of solid wood, similar to the Piano Design Chair but with lowered back and wider seat.*

*On this page: total black pigmented oak - walnut without knots, oil finish. On the left: walnut without knots, oil finish.*

*Stuhl völlig aus Massivholz. Variante des Modells Piano Design Chair, jedoch mit einer breiteren Sitzfläche und einer niedrigeren Rückenlehne. Auf dieser Seite: Eiche pigmentiert total black - Nussbaum ohne Knoten geölt. Links: Nussbaum ohne Knoten geölt.*

CM: L. 45,5 · P. 51,5 · H. 46/80,5

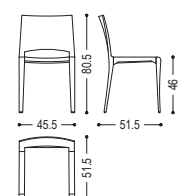

PANCHE · BENCHES · BÄNKE



**BETTY BENCH** 146-147



**BUNGALOW BENCH** 148-149



**IRON LIGHT BENCH** 150-151



**PIAZZA SCALA** 152-153



**SEQUOIA - SEQUOIA 2.0** 154-157



## BETTY BENCH

TERRY DWAN

Panca con struttura realizzata in legno massello, dotata di schienale con bordo naturale e comoda seduta imbottita rivestita in pelle o tessuto con cuciture a vista. Disponibile nella versione lineare o angolare.

Qui e nella pagina destra: struttura noce con nodi, finitura olio e pelle Utah 105.

*Bench with solid wood structure. Back with natural edge and comfortable padded seat upholstered in leather or fabric with exposed stitching. Available both in linear and corner version.*

*In the pictures: structure in walnut with knots, oil finish, and leather Utah 105.*

*Bank mit Massivholzstruktur. Rückenlehne mit Oberkante natur und gepolsterte Sitzfläche, Bezug aus Leder oder Stoff mit dekorativen Nähten. Auch als Eckbank erhältlich.*

*In den Fotos: Struktur aus Nussbaum mit Knoten geölt und Leder Utah 105.*

CM: L. 200/220 · P. 53 · H. 51/83

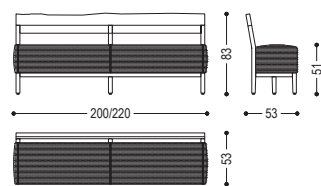

Per maggiori informazioni consultare il Pricelist  
For any further information please refer to the Pricelist  
Weitere Informationen entnehmen Sie bitte der Preisliste



## BUNGALOW BENCH

JAMIE DURIE



Panca con struttura realizzata in legno massello completamente tornita, assemblata e levigata a mano. La seduta si caratterizza per un intreccio di stringhe di pelle o tessuto.  
Qui e nella pagina sinistra: struttura rovere senza nodi, finitura cera e pelle Utah 105.

*Bench with structure in solid wood turned, assembled and sanded completely by hand. The seat is characterized by interwoven strips of leather or fabric.  
In the pictures: structure in oak without knots, wax finish, and leather Utah 105.*

*Bank mit Gestell aus Massivholz, von Hand gedrechselt, aufgebaut undgeschliffen.  
Sitzfläche aus Streifen in Leder oder Stoff.  
In den Fotos: Gestell aus Eiche ohne Knoten gewachst und Leder Utah 105.*

CM: L. 121 · P. 44 · H. 42

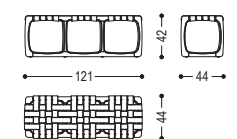

Per maggiori informazioni consultare il Pricelist  
For any further information please refer to the Pricelist  
Weitere Informationen entnehmen Sie bitte der Preisliste

## IRON LIGHT BENCH

GIOVANNA AZZARELLO



Panca con scocca realizzata in listellare con seduta e schienale imbottiti e rivestiti in pelle o tessuto con cuciture a vista, abbinata ad una base essenziale e lineare formata da un tubolare intrecciato in ferro vuoto. Disponibile a richiesta in tubolare intrecciato in ferro pieno.

Qui e nella pagina destra: pelle Camoscio 26 e base in ferro laccato irondust.

*Bench with structure in blockboard and padded seat and backrest, both covered with leather or fabric with exposed stitching, combined with an essential and linear base made of intertwined tubular iron, empty inside. Upon request available in intertwined full tubular iron.*

*In the pictures: leather Camoscio 26 and iron base lacquered irondust.*

*Bank mit Struktur aus Tischlerplatte, gepolstert und mit Leder- oder Stoffbezug mit dekorativen Nähten. Design essentiell und linear, besteht das Untergestell aus einem gebogenen hohlen Stahlrohr. Auf Anfrage aus einem gebogenem vollem Stahlrohr erhältlich.*

*In den Fotos: Leder Camoscio 26 und Gestell lackiert irondust.*

CM: L. 200/220/240/260/280/300 · P. 65,3 · H. 50/83

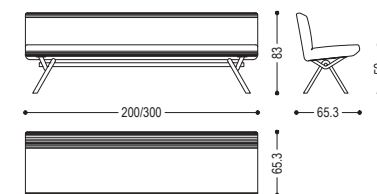



## PIAZZA SCALA

MICHELE DE LUCCHI



CM: L.64,5/125/185,5/246 · P. 40 · H. 46

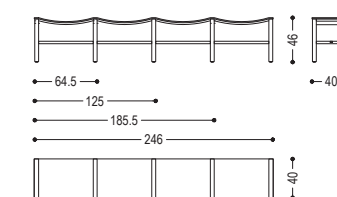

Panca interamente realizzata in legno massello a liste incollate, caratterizzata da un unico piano ergonomico in legno che continua per tutta la lunghezza della seduta e sostenuta da gambe squadrate.

Qui e nella pagina sinistra: noce con nodi, finitura olio.

*Bench completely made of solid wood in glued lists, characterized by a single ergonomic seat on the entire length and square legs.  
In the pictures: walnut with knots, oil finish.*

*Bank mit einer ergonomischer Sitzfläche völlig aus verleimten Massivholzleisten gefertigt und rechteckigen Beinen.  
In den Fotos: Nussbaum mit Knoten geölt.*

## SEQUOIA · SEQUOIA 2.0

CENGIZ CIVAN



CM: L. 240/260 · P. 62 · H. 50/96

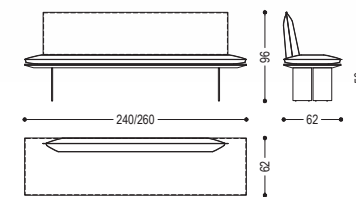

Per maggiori informazioni consultare il Pricelist  
For any further information please refer to the Pricelist  
Weitere Informationen entnehmen Sie bitte der Preisliste

Panca con seduta realizzata in legno massello a liste incollate con lati pantografati, in abbinata a gambe in ferro. Seduta e schienale dotati di maxi cuscini rivestiti in pelle o tessuto con cuciture a vista, in due versioni diverse. Disponibile nella versione lineare o angolare.

Qui, a sinistra e nelle pagine successive: noce senza nodi, finitura olio e pelle Camoscio 10, base ferro laccato irondust.

*Bench with seat made of solid wood in glued lists and legs in iron. The seat and the back are equipped with maxi cushions covered in leather or fabric with exposed stitching, in two different versions. Available both in linear and corner version.*

*In the pictures: walnut without knots, oil finish, and leather Camoscio 10, iron base lacquered irondust.*

*Bank mit Massivholzstruktur und Gestell aus Eisen. Die Sitz- und Rückenkissen sind aus Leder oder Stoff mit dekorativen Nähten bezogen, in zwei verschiedenen Varianten erhältlich. Auch als Eckbank erhältlich. In den Fotos: Nussbaum ohne Knoten geölt und Leder Camoscio 10, Gestell lackiert irondust.*







SGABELLI · *STOOLS* · *HOCKER*



**BARNEY** 160-161



**BETTY POUF · BETTY POUF.1** 162-163



**BUNGALOW - BUNGALOW BAR STOOL** 164-165



**DINO** 166-167



**ROLL** 168-169



**ROPE** 170-171



**TAK** 172-173





## BARNEY

TERRY DWAN



### BARNEY SMALL

CM: L. 50 · P. 34,5 · H. 48

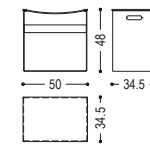

### BARNEY BIG

CM: L. 50 · P. 34,5 · H. 68

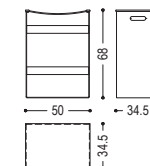

Sgabello caratterizzata da una struttura in ferro sagomata con seduta rivestita in pelle mod. "Utah". Disponibile nelle due versioni Barney Small e Barney Big. Qui e nella pagina sinistra: pelle Utah 107 e ferro laccato trasparente opaco.

*Stool with iron structure with seat upholstered in leather Utah. Available in two different heights: Barney Small and Barney Big.*

*In the pictures: leather Utah 107 and natural iron matt transparent lacquered.*

*Hoher mit Eisengestell und Sitz aus Leder „Utah“. In zwei Höhen erhältlich: Barney Small und Barney Big.*

*In den Fotos: Leder Utah 107 und Natureisen matt transparent lackiert.*



## BETTY POUF · BETTY POUF.1

TERRY DWAN



Sgabello con imbottitura morbida e rivestimento in pelle o tessuto, lavorato e cucito a mano, caratterizzato da doppie cuciture angolari disponibili in due versioni.

Qui: pelle Utah 107 - pelle Utah 102. Nella pagina sinistra: tessuto Divina Melange 2-120 - tessuto Divina Melange 2-170.

*Stool with soft padding, upholstered in leather or fabric that is hand decorated and stitched with double corner stitching. Stiches available in two different versions.*

*On this page: leather Utah 107 - leather Utah 102. On the left: fabric Divina Melange 2-120 - fabric Divina Melange 2-170.*

*Weich gepolsterter Hocker mit Leder oder Stoff bezogen, handgearbeitet und genäht. Durch Doppelnähte an den Ecken charakterisiert, in zwei Varianten erhältlich.*

*Auf dieser Seite: Leder Utah 107 - Leder Utah 102. Links: Stoff Divina Melange 2-120 - Stoff Divina Melange 2-170.*

BETTY POUF SMALL  
CM: L. 36 · P. 36 · H. 42,5

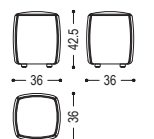

BETTY POUF  
CM: L. 36 · P. 36 · H. 51,5

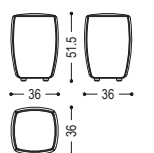

## BUNGALOW · BUNGALOW BAR STOOL

JAMIE DURIE



BUNGALOW

CM: L. 44 · P. 44 · H. 42

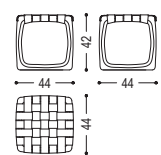

BUNGALOW BS-68

CM: L. 39,5 · P. 39,5 · H. 68

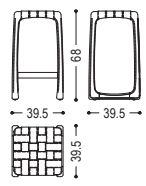

BUNGALOW BS-74

CM: L. 39,5 · P. 39,5 · H. 74

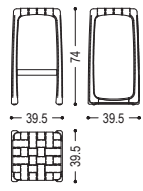

Sgabello con struttura in legno massello completamente tornita, assemblata e levigata a mano. La seduta si caratterizza per un intreccio di stringhe di pelle o tessuto. Nella versione in tessuto previsto rinforzo strutturale all'interno del rivestimento.

Qui: struttura noce senza nodi, finitura olio e pelle Utah 102 - struttura rovere senza nodi, finitura cera e pelle Utah 102. Nella pagina destra: struttura noce senza nodi, finitura olio e pelle Utah 102.

*Stool with structure in solid wood turned, assembled and sanded completely by hand. The seat is characterized by interwoven strips of leather or fabric. When in abric these strips have a structural support inside.*

*On this page: structure in walnut without knots, oil finish, and leather Utah 102 - structure in oak without knots, wax finish, and leather Utah 102. On the right: structure in walnut without knots, oil finish, and leather Utah 102.*

*Hocker mit Gestell aus Massivholz, von Hand gedrechselt, aufgebaut und geschliffen. Sitzfläche aus Streifen in Leder oder Stoff. Bei der Variante in Stoff sind diese Streifen innen strukturell verstärkt.*

*Auf dieser Seite: Gestell aus Nussbaum ohne Knoten geölt und Leder Utah 102 - Gestell aus Eiche ohne Knoten gewachst und Leder Utah 102. Rechts: Gestell aus Nussbaum ohne Knoten geölt und Leder Utah 102.*



# DINO

TERRY DWAN



Sgabello da bar con poggiatesta, caratterizzato da struttura in legno massello con schienale dal bordo naturale e seduta imbottita rivestita in pelle o tessuto. Disponibile in due altezze differenti.

Qui e nella pagina destra: struttura noce senza nodi, finitura olio e pelle Utah 102.

*Bar stool with footrests, characterized by a structure in solid wood with backrest with a natural side. Seat padded and covered in leather or fabric. Available in two different heights.*

*In the pictures: structure in walnut without knots, oil finish, and leather Utah 102.*

*Barhocker mit Fußstützen. Gestell aus Massivholz, Rückenlehne mit naturbelassener Oberkante, gepolsterte Sitzfläche mit Leder oder Stoff bezogen. In zwei verschiedenen Höhen erhältlich.*

*In den Fotos: Gestell aus Nussbaum ohne Knoten geölt und Leder Utah 102.*

DINO 1

CM: L. 40,5 · P. 44,8 · H. 74/88

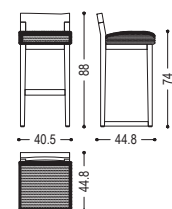

DINO 2

CM: L. 40,5 · P. 44,8 · H. 80/94

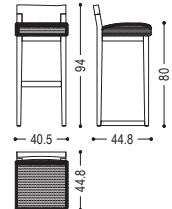



## ROLL

Sgabello composto da una fascia di pelle Utah arrotolata, rappresenta un ceppo sezionato dove gli strati di pelle evocano gli anelli d'invecchiamento dell'albero.

Qui e nella pagina sinistra: pelle Utah 105.

*Stool composed of a band of rolled Utah leather, it represents a sectioned log where the layers of leather evoke the rings of the tree.*

*In the pictures: leather Utah 105.*

*Hocker aus einem gerollten Utah Lederhaut gefertigt. Die Schichte des Leders erinnern an den Baumringen eines geschnittenen Stamms.*

*In den Fotos: Leder Utah 105.*

CM: Ø 35,5 · H. 45

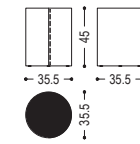

STEFANO LAROTONDA

## ROPE

JAMIE DURIE



CM: Ø 33-36 · H. 43

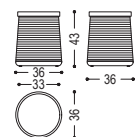

Sgabello realizzato in legno massello, caratterizzato da fili di corda di canapa grezza arrotolati su tutta la struttura.

Qui e nella pagina destra: noce senza nodi, finitura olio.

*Stool made of solid wood, characterised by strings of hemp rope wound over the entire structure.*

*In the pictures: walnut without knots, oil finish.*

*Hocker aus Massivholz, mit Hanfseil um das Gestell gewickelt.*

*In den Fotos: Nussbaum ohne Knoten geölt.*





## TAK

MICHELE TAVANO



CM: L. 38 · P. 38,7 · H. 43,4

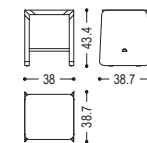

Sgabello interamente realizzato in legno massello composto da tre lati smussati e giuntati tra loro e da poggiapiedi innestato sui fianchi laterali.

Qui e a sinistra: noce senza nodi, finitura olio e rovere senza nodi, finitura cera.

*Stool completely made of solid wood, composed of three pieces with smoothed sides, jointed together and with footrest inserted between the legs.*

*In the pictures: walnut without knots, oil finish, and oak without knots, wax finish.*

*Hocker komplett aus Massivholz aus drei Stücken mit abgerundeten Kanten, zusammengefügt und Fußstütze an den Seiten eingefügt.*

*In den Fotos: Nussbaum ohne Knoten geölt und Eiche ohne Knoten gewachst.*





# CONTENITORI

## PIECES OF FURNITURE · MÖBEL



**ADA 1.0** 176-177



**ADA 2.0** 178-179



**CAMBUSA WINE / JUMBO** 180-183



**CAMBUSA COOK / JUMBO** 184-187



**CAMBUSA WINE GLASS / JUMBO** 188-189



**CAMBUSA COOK GLASS / JUMBO** 190-191



**CAMBUSA EVO / JUMBO** 192-193



**COBLENZA** 194-195



**GASTONIA** 196-197



**KYOTO 2.0** 198-199



**LIGHT** 200-201



**PANDORA** 202-205



**PANDORA GLASS** 206-209



**PANDORA UP SMALL** 210-211



**RIALTO 2013** 212-213



**RIALTO FLY / FLY OPEN** 214-215



**SIPARIO 2011** 216-217



**VITREA** 218-221

ADA 1.0

C.R.&S. RIVA1920



ADA 1.2

CM: L. 198 · P. 48/53 · H. 85

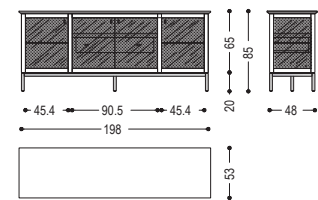

Per maggiori informazioni consultare il Pricelist  
For any further information please refer to the Pricelist  
Weitere Informationen entnehmen Sie bitte der Preisliste



Vetrina bassa con struttura in legno massello caratterizzata da ante e spalle in vetro, utilizzato anche per i ripiani interni. Ripiano centrale fisso in legno. Disponibile in versione a 2 o 4 ante in vetro, con cassetiera interna o esterna, e base in ferro. Innovativo sistema di luci LED con accensione autonoma e ricarica wireless.

Qui e nella pagina destra: struttura in rovere pigmentato total black e base ferro laccato effetto bronzo antico spazzolato opaco.

*Low glass cabinet with solid wood structure characterized by glass doors, sides and internal shelves. Fix middle shelf in wood. Available with 2 or 4 glass doors, with internal or external drawers, and iron base. Innovative LED system with spots, with independent activation and wireless charging.*

*In the pictures: structure in total black pigmented oak and iron base lacquered aged bronze matt brushed effect.*

*Vitrine mit Struktur bestehend aus Massivholz, Türen, Seiten und Einlegeböden aus Glas. Fester Mittelboden aus Holz. Mit 2 oder 4 Türen, mit inneren Schubladen und Außenschubladen erhältlich, und Untergestell aus Eisen. Innovatives LED-System durch Spotlights mit unabhängiger Einschaltung und kabellosem Laden.*

*In den Fotos: Struktur aus Eiche pigmentiert total black und Eisengestell lackiert Bronze-Effekt matt gebürstet.*

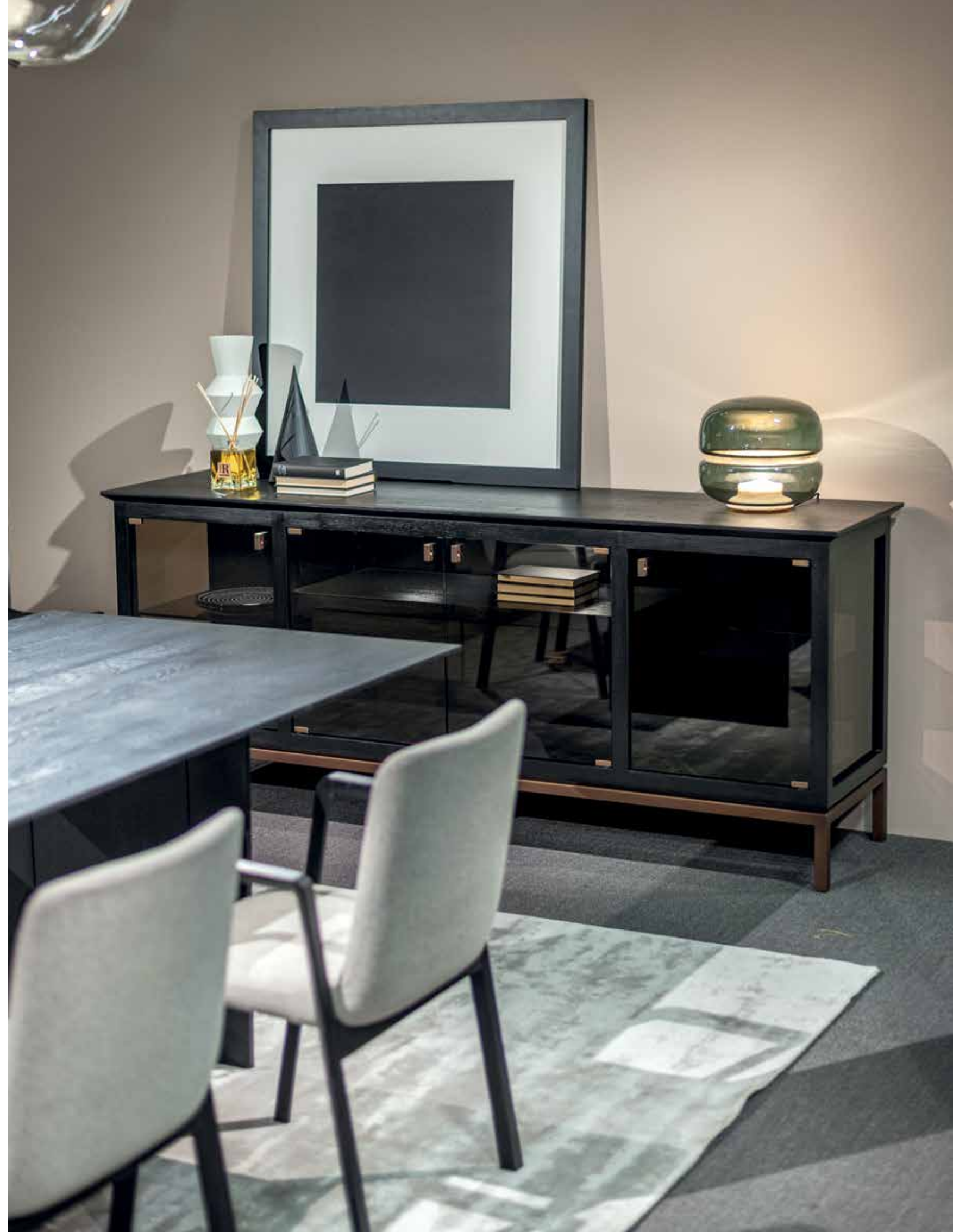



## ADA 2.0

C.R. & S. RIVA1920

Vetrina alta con struttura in legno massello caratterizzata da ante e spalle in vetro, utilizzato anche per i ripiani interni. Ripiano centrale fisso in legno. Disponibile in versione a 2 ante in vetro, con cassetteria interna o esterna, e base in ferro. Innovativo sistema di luci LED con accensione autonoma e ricarica wireless.

Qui: rovere pigmentato total black, vetro bronzato, schienale rivestito in pelle Cristal 65 e base ferro laccato effetto bronzo antico spazzolato opaco - noce senza nodi, finitura olio, vetro fumé e base ferro laccato effetto rame antico spazzolato opaco. A sinistra: rovere pigmentato total black, vetro bronzato, schienale rivestito in pelle Cristal 65 e base ferro laccato effetto bronzo antico spazzolato opaco.

*Tall glass cabinet with solid wood structure characterized by glass doors, sides and internal shelves. Fix middle shelf in wood. Available with 2 glass doors, with internal or external drawers, and iron base. Innovative LED system with spots, with independent activation and wireless charging.*

*On this page: total black pigmented oak, bronzed glass, back covered in leather Cristal 65 and iron base lacquered aged bronze matt brushed effect - walnut without knots, oil finish, smoked glass and iron base lacquered aged copper matt brushed effect. On the left: total black pigmented oak, bronzed glass, back covered in leather Cristal 65 and iron base lacquered aged bronze matt brushed effect.*

*Vitrine mit Struktur bestehend aus Massivholz, Türen, Seiten und Einlegeböden aus Glas. Fester Mittelboden aus Holz. Mit 2 Türen, mit inneren Schubladen und Außenschubladen erhältlich, und Untergestell aus Eisen. Innovatives LED-System durch Spotlights mit unabhängiger Einschaltung und kabellosem Laden.*

*Auf dieser Seite: Eiche pigmentiert total black, bronziertes Glas, Rückwand mit Leder Cristal 65 bezogen und Eisengestell lackiert Bronze-Effekt matt gebürstet - Nussbaum ohne Knoten geölt, Rauchglas und Eisengestell lackiert Kupfer-Effekt matt gebürstet. Links: Eiche pigmentiert total black, bronziertes Glas, Rückwand mit Leder Cristal 65 bezogen und Eisengestell lackiert Bronze-Effekt matt gebürstet.*



ADA 2.2  
CM: L. 118 · P. 48/53 · H. 184,4

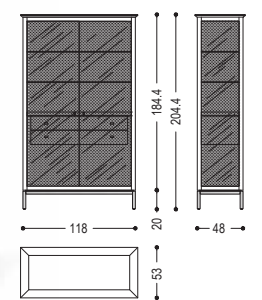

Per maggiori informazioni consultare il Pricelist  
For any further information please refer to the Pricelist  
Weitere Informationen entnehmen Sie bitte der Preisliste

## CAMBUSA WINE / JUMBO

GIULIANO CAPPELLETTI

Mobile contenitore multifunzione in listellare e massello dotato di doppia anta con angolo di apertura a 180°. L'allestimento interno prevede vani contenitori porta bottiglie e bicchieri, con possibilità di inserire piccoli elettrodomestici (nella versione Jumbo). Le ante sono contenitive e al loro interno è possibile sistemare bicchieri e accessori. L'interno del mobile è illuminato per mezzo di strisce a LED posizionate sulla spalla centrale, la cui accensione risulta automatica tramite sensori che si attivano all'apertura delle ante.

Qui e nelle pagine successive: rovere senza nodi, finitura cera. A destra: noce senza nodi, finitura olio.

*Multifunctional storage unit in blockboard and solid wood, with double doors opening to 180°. Designed as a wine-storage unit, inside there are grids and containers for bottles and glasses, with the possibility to insert small electrical appliances (Jumbo version). The doors' inner structure allows to organise glasses and accessories. The inside is illuminated by LED strips along the inner side, activated automatically via sensors when the doors are opened.*

*On this and the following pages: oak without knots, wax finish. On the right: walnut without knots, oil finish.*

*Mehrzweckschrank aus Massiv- und Furnierschichtholz, mit zwei um 180 Grad drehbaren Türen versehen. Innen ist der Schrank mit Flaschen- und Gläserhaltern ausgestattet. Es besteht die Möglichkeit, in der Version Jumbo, kleine Geräte einzubauen. Die Regale an der Inneseite der Türen sind dafür gedacht, um Gläser und Sonstiges zu verstauen. In der Schrank-Mittelseitenwand sind Led-Lichtleisten montiert und dank eines Sensors geht das Licht beim Öffnen der Türen automatisch an.*

*Auf dieser und auf den nächsten Seiten: Eiche ohne Knoten gewachst. Rechts: Nussbaum ohne Knoten geölt.*

CM: L. 127/254,6 · P. 78,7 · H. 201

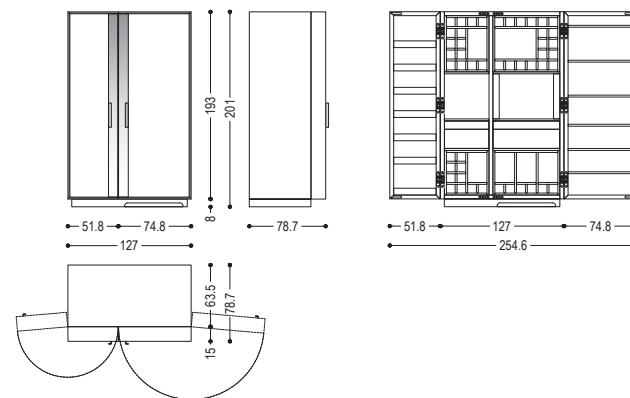

Per maggiori informazioni consultare il Pricelist  
For any further information please refer to the Pricelist  
Weitere Informationen entnehmen Sie bitte der Preisliste

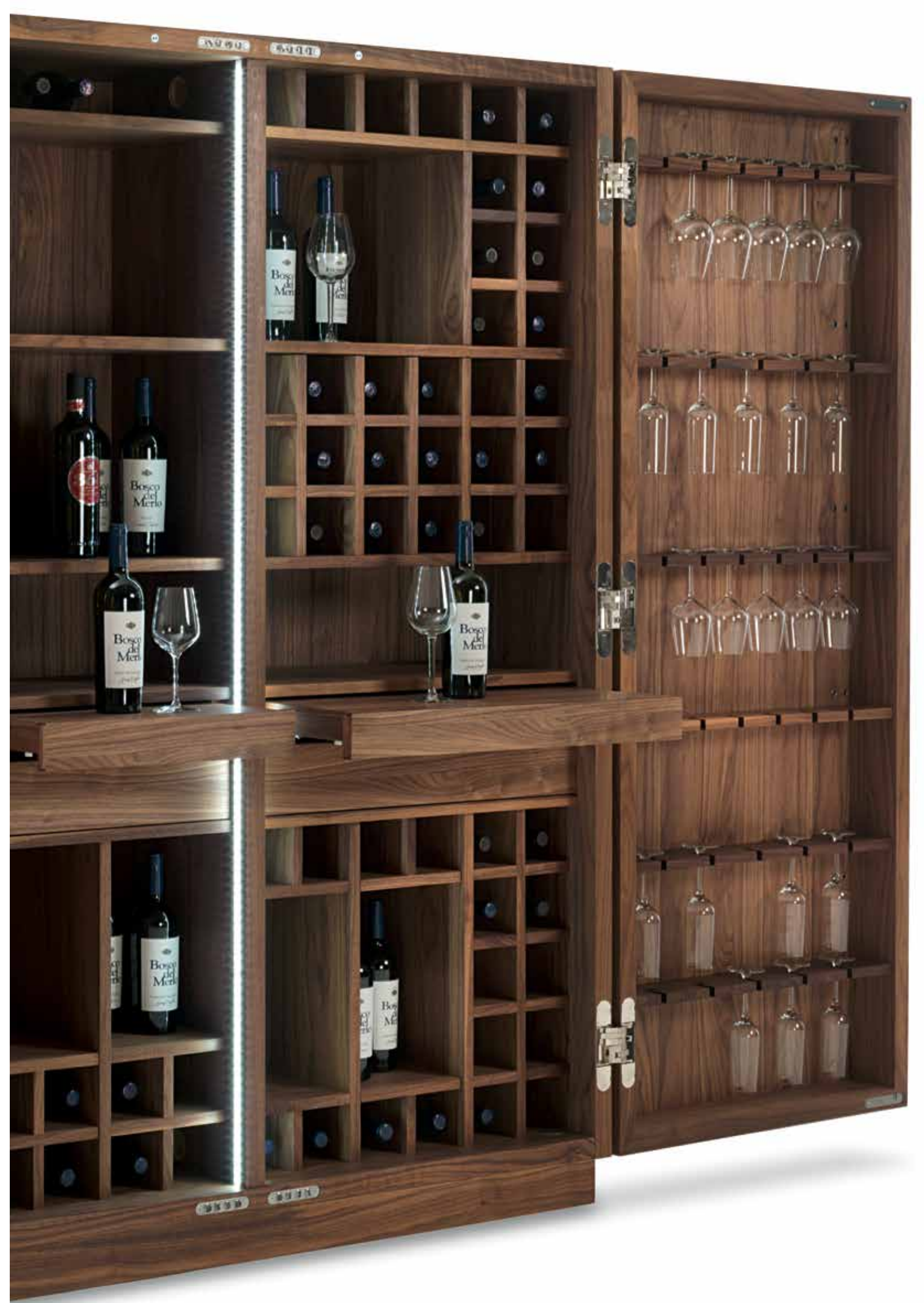

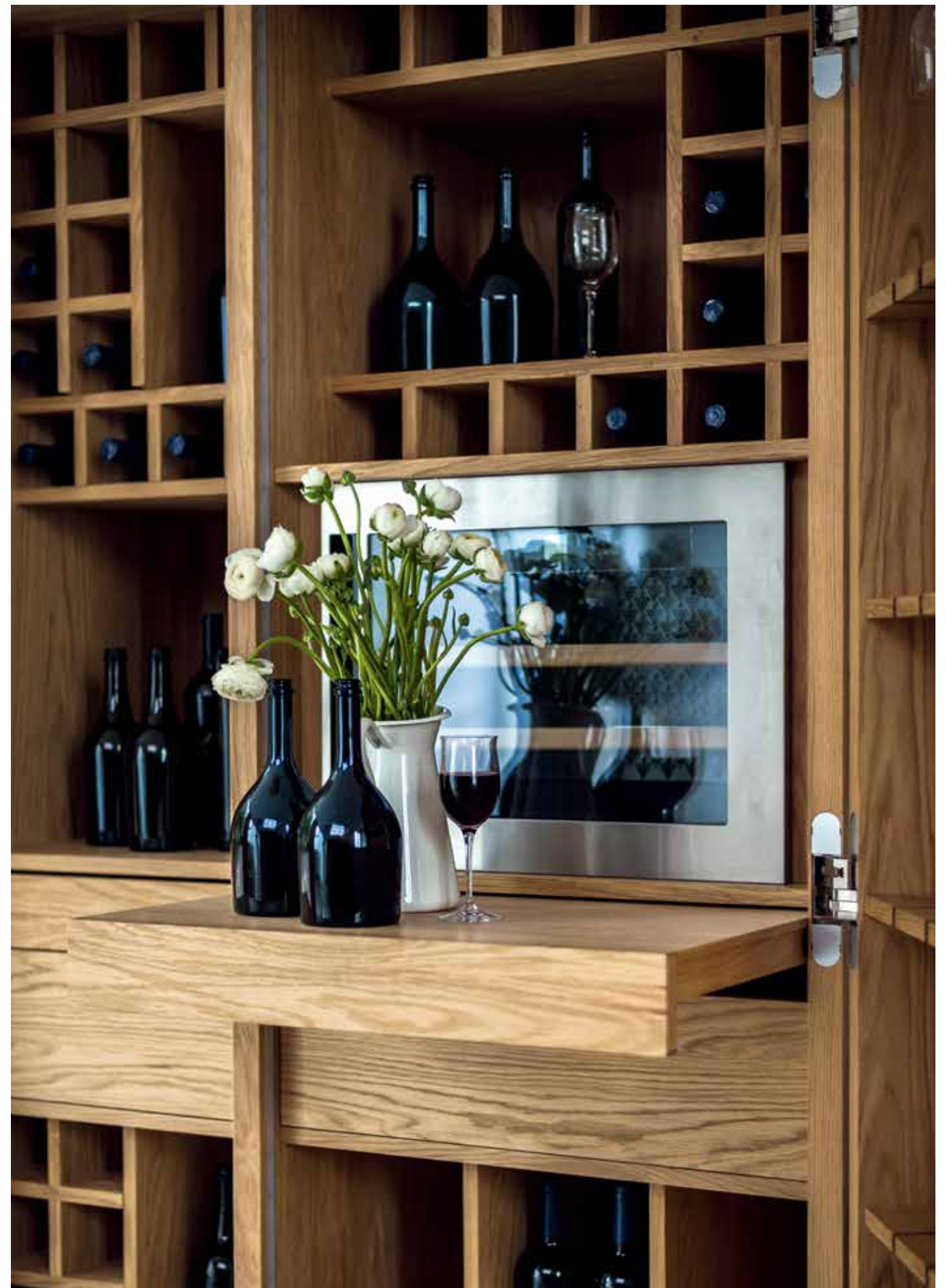

## CAMBUSA COOK / JUMBO

GIULIANO CAPPELLETTI



Mobile contenitore multifunzione in listellare e massello dotato di doppia anta con angolo di apertura a 180°. L'allestimento prevede vani contenitori di varie dimensioni, con possibilità di inserire piccoli elettrodomestici (nella versione Jumbo). Le ante sono contenitive e al loro interno è possibile sistemare bicchieri, stoviglie e accessori. L'interno del mobile è illuminato per mezzo di strisce a LED posizionate sulla spalla centrale, la cui accensione risulta automatica tramite sensori che si attivano all'apertura delle ante.

Qui, a sinistra e nelle pagine successive: rovere senza nodi, finitura cera.

*Multifunctional storage unit in blockboard and solid wood, with double doors opening to 180°. Designed as a kitchen unit, inside there are containers in various dimensions, with the possibility to insert small electrical appliances (Jumbo version). The doors' inner structure allows to organise glasses, dishes and accessories. The inside is illuminated by LED strips along the inner side, activated automatically via sensors when the doors are opened.*

*In the pictures: oak without knots, wax finish.*

*Mehrzweckschrank aus Massiv- und Furnierschichtholz, mit zwei um 180 Grad drehbaren Türen versehen. Innen ist der Schrank in Fächern verschiedener Größe unterteilt. Es besteht die Möglichkeit, in der Version Jumbo, kleine Geräte einzubauen. Die Regale an der Inneseite der Türen sind dafür gedacht, um Gläser, Geschirr und Sonstiges zu verstauen. In der Schrank-Mittelseitenwand sind Led-Lichtleisten montiert und dank eines Sensors geht das Licht beim Öffnen der Türen automatisch an. In den Fotos: Eiche ohne Knoten gewachst.*

CM: L. 127/254,6 · P. 78,7 · H. 201

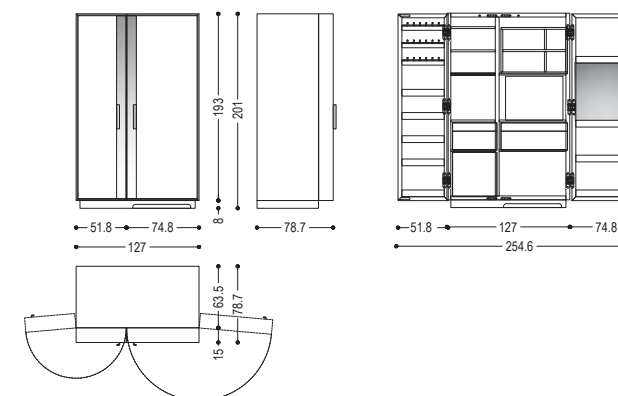

Per maggiori informazioni consultare il Pricelist  
For any further information please refer to the Pricelist  
Weitere Informationen entnehmen Sie bitte der Preisliste



ci pane in pane

TOAST

## CAMBUSA WINE GLASS / JUMBO

GIULIANO & GABRIELE CAPPELLETTI

Mobile contenitore multifunzione in listellare e massello dotato di doppia anta in vetro con angolo di apertura a 180°. L'allestimento prevede vani contenitori porta bottiglie e bicchieri, con possibilità di inserire piccoli elettrodomestici (nella versione Jumbo). L'interno del mobile è illuminato per mezzo di strisce a LED posizionate sulla spalla centrale, la cui accensione risulta automatica tramite sensori che si attivano all'apertura delle ante.

Qui e nella pagina destra: noce senza nodi, finitura olio e anta in vetro fumè.

*Multifunctional storage unit in blockboard and solid wood, with double glass doors opening to 180°. Designed as a wine-storage unit, inside there are grids and containers for bottles and glasses, with the possibility to insert small electrical appliances (Jumbo version). The inside is illuminated by LED strips along the inner side, activated automatically via sensors when the doors are opened.*

*In the pictures: walnut without knots, oil finish, and door in smoked glass.*

*Mehrzweckschrank aus Massiv- und Furnierschichtholz, mit zwei um 180 Grad drehbaren Glastüren versehen. Innen ist der Schrank mit Flaschen- und Gläserhaltern ausgestattet. Es besteht die Möglichkeit, in der Version Jumbo, kleine Geräte einzubauen. In der Schrank-Mittelseitenwand sind Led-Lichtleisten montiert und dank eines Sensors geht das Licht beim Öffnen der Türen automatisch an.*

*In den Fotos: Nussbaum ohne Knoten geölt und Tür aus Rauchglas.*



CM: L. 127/254,6 · P. 78,9 · H. 201

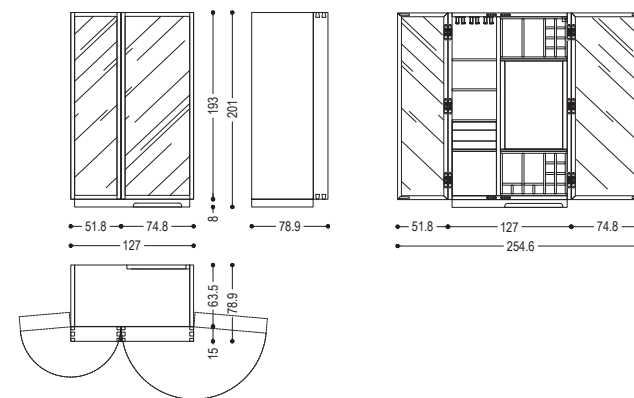

Per maggiori informazioni consultare il Pricelist  
For any further information please refer to the Pricelist  
Weitere Informationen entnehmen Sie bitte der Preisliste





## CAMBUSA COOK GLASS / JUMBO

GIULIANO & GABRIELE CAPPELLETTI

Mobile contenitore multifunzione in listellare e massello dotato di doppia anta in vetro con angolo di apertura a 180°. L'allestimento prevede vani contenitori di varie dimensioni, con possibilità di inserire piccoli elettrodomestici (nella versione Jumbo). L'interno del mobile è illuminato per mezzo di strisce a LED posizionate sulla spalla centrale, la cui accensione risulta automatica tramite sensori che si attivano all'apertura delle ante. Qui: rovere senza nodi, finitura cera e anta in vetro fumè. Nella pagina sinistra: rovere con nodi tabacco e anta in vetro trasparente.

Multifunctional storage unit in blockboard and solid wood, with double glass doors opening to 180°. Designed as a kitchen unit, inside there are containers in various dimensions, with the possibility to insert small electrical appliances (Jumbo version). The inside is illuminated by LED strips along the inner side, activated automatically via sensors when the doors are opened.

On this page: oak without knots, wax finish, and door in smoked glass. On the left: oak without knots tabacco and door in clear glass.

Mehrzweckschrank aus Massiv- und Furnierschichtholz, mit zwei um 180 Grad drehbaren Glstüren versehen. Innen ist der Schrank in Fächern verschiedener Größe unterteilt. Es besteht die Möglichkeit, in der Version Jumbo, kleine Geräte einzubauen. In der Schrank-Mittelseitenwand sind Led-Lichtleisten montiert und dank eines Sensors geht das Licht beim Öffnen der Türen automatisch an.

Auf dieser Seite: Eiche ohne Knoten gewachst und Tür aus Rauchglas. Links: Eiche ohne Knoten Tabacco und Tür aus transparentem Glas

CM: L. 127/254,6 · P. 78,9 · H. 201

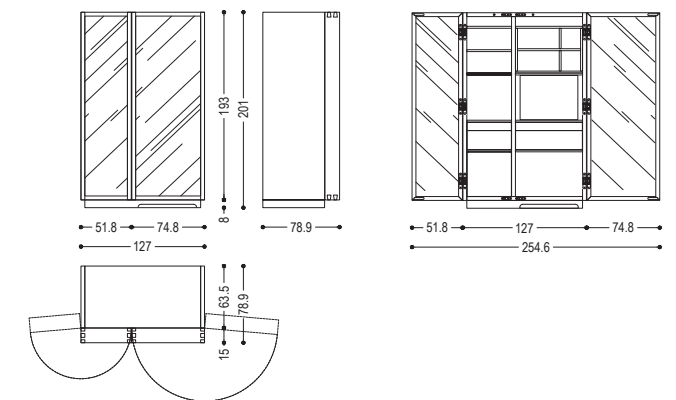

Per maggiori informazioni consultare il Pricelist  
For any further information please refer to the Pricelist  
Weitere Informationen entnehmen Sie bitte der Preisliste





## CAMBUSA EVO / JUMBO

GIULIANO & GABRIELE CAPPELLETTI

Mobile contenitore multifunzione in legno listellare dotato di doppia anta in vetro fumè con angolo di apertura a 180° e maniglia in legno applicata. L'attrezzatura e i complementi interni sono progettati sulla base delle esigenze contenitive e funzionali, con possibilità di inserire piccoli elettrodomestici (nella versione Jumbo). L'interno del mobile è illuminato per mezzo di strisce a LED posizionate sulla spalla centrale, la cui accensione risulta automatica tramite sensori che si attivano con il passaggio della mano.

Qui e nella pagina sinistra: noce senza nodi, finitura olio e anta in vetro fumè.

*Multifunctional storage unit in blockboard, with double doors in smoked glass opening to 180° and with wooden handles. The unit and the accessories are designed to meet storage and functional needs, with the possibility to insert small electrical appliances (Jumbo version). The inside is illuminated by LED strips along the inner side, activated automatically via touch sensors by the passage of the hand.*

*In the pictures: walnut without knots, oil finish, and anta in smoked glass.*

*Mehrzweckschrank aus Massiv- und Furnierschichtholz, mit zwei um 180 Grad drehbaren Türen aus Rauchglas mit Holzgriffen versehen. Innen ist der Schrank funktionsgemäß unterteilt und ausgestattet. Es besteht die Möglichkeit, in der Version Jumbo, kleine Geräte einzubauen. In der Schrank-Mittelseitenwand sind Led-Lichtleisten montiert und dank eines Sensors geht das Licht beim Öffnen der Türen automatisch an. In den Fotos: Nussbaum ohne Knoten geölt und Tür aus Rauchglas.*



CM: L. 127/254,6 · P. 60,2 · H. 201

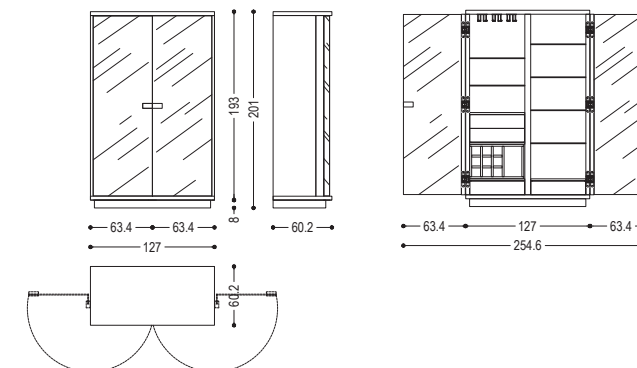

Per maggiori informazioni consultare il Pricelist  
For any further information please refer to the Pricelist  
Weitere Informationen entnehmen Sie bitte der Preisliste

COBLENZA

C.R.&S. RIVA1920



Credenza interamente realizzata in legno massello, dotata di ampio piano lavoro e cassetti assemblati con incastri a coda di rondine. Piedini in massello rialzano il mobile da terra.

Qui e nella pagina destra: noce con nodi, finitura olio.

*Chest of drawers completely made of solid wood, with a wide work surface and drawers assembled with dovetail joints. Solid wood feet raise the unit from the ground.*

*In the pictures: walnut with knots, oil finish.*

*Werkbank völlig aus Massivholz gefertigt, mit breiter Arbeitsplatte und Schubladen mit Schwalbenschwanzverbindungen versehen. Stehend auf Massivholz-Füßen.*

*In den Fotos: Nussbaum mit Knoten geölt.*

CM: L. 239 · P. 75 · H. 91,5

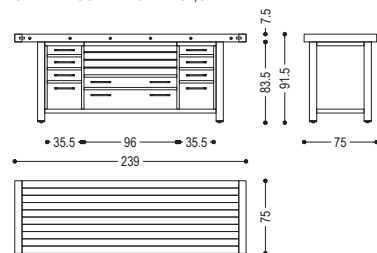

# GASTONIA

C.R.&S. RIVA1920



CM: L. 108 · P. 46,2 · H. 158

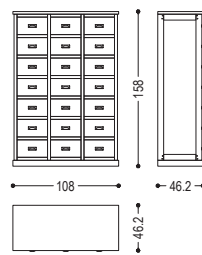

Per maggiori informazioni consultare il Pricelist  
For any further information please refer to the Pricelist  
Weitere Informationen entnehmen Sie bitte der Preisliste

Cassettiera dalle linee classiche nello stile shaker americano, caratterizzata da struttura in legno massello e multistrato. Dotata di cassetti assemblati con incastri a coda di rondine, e sistema di scorrimento a scatola, tipico dei canterani del 1700.

Qui: noce senza nodi, finitura olio. Nella pagina destra: rovere senza nodi, finitura cera.

*Dresser featuring the classic line of the American Shaker style, in solid wood and veneered blockboard. Drawers assembled with dovetail joints and traditional wooden rails, typical of the 1700s cabinets.*

*On this page: walnut without knots, oil finish. On the right: oak without knots, wax finish.*

*Kommode mit klassischen Linien im amerikanischen Shaker-Stil, deren Besonderheit der Rahmen aus Massiv- und Sperrholz ist. Schubladen auf Holzführungen mit Schwalbenschwanzverbindungen wie bei den Möbeln des 18. Jahrhunderts.*

*Auf dieser Seite: Nussbaum ohne Knoten geölt. Rechts: Eiche ohne Knoten gewachst.*

## KYOTO 2.0

C.R.&S. RIVA1920



CM: L. 233,4 · P. 45 · H. 75

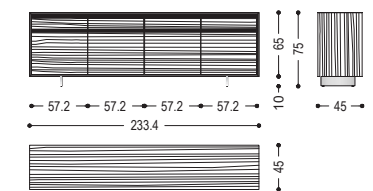

Credenza in legno massello e listellare, dotata di struttura fine, cassetti assemblati con incastri a coda di rondine e ante con maniglie fresate nei frontali. Basamento in ferro.  
Qui e a sinistra: struttura in rovere pigmentato total black e frontali in rovere senza nodi neutro.

*Sideboard in solid wood and blockboard, with thin structure. Drawers assembled with dovetail joints and doors, with grooved handles. Thin iron legs.*

*In the pictures: structure in total black pigmented oak and fronts in neutro oak without knots.*

*Sideboard aus Massiv- und Furnierschichtholz, verfügt über Drehtüren, Schubladen mit Schwabenschwanzverbindungen und Griffmulden. Fußwangen aus Eisen.*

*In den Fotos: Struktur aus Eiche pigmentiert total black und Fronten aus Eiche ohne Knoten neutro.*

# LIGHT

MATTEO THUN



Vetrina caratterizzata da struttura in legno massello e listellare con ante in vetro trasparente dotate di pomoli, disponibile nella versione anta doppia o singola. I cassetti interni sono assemblati con incastri a coda di rondine. Quattro sottili piedini sospendono l'elemento da terra.

Qui: noce senza nodi, finitura olio. Nella pagina destra: rovere senza nodi, finitura cera.

*Glass cabinet made of solid wood and blockboard, with doors in clear glass with wooden knobs, available with double or single door. The inner drawers are assembled with dovetail joints. Four thin feet raise the unit from the ground.*

*On this page: walnut without knots, oil finish. On the right: oak without knots, wax finish.*

*Vitrine mit Korpus aus Massiv- und Furnierschichtholz und Klarglastüren mit Holzknöpfen, verfügt über Innenschubladen mit Schwalbenschwanzverbindungen und steht auf dünnen Holzfüßchen. In zwei Versionen verfügbar: mit einer Tür oder mit zwei Türen.*

*Auf dieser Seite: Nussbaum ohne Knoten geölt. Rechts: Eiche ohne Knoten gewachst.*

LIGHT-VETRINA  
CM: L. 140 · P. 48 · H. 177

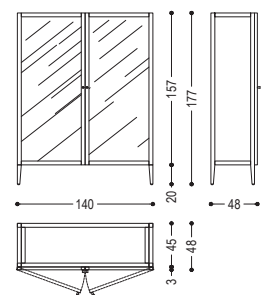

LIGHT SMALL  
CM: L. 70 · P. 48 · H. 177

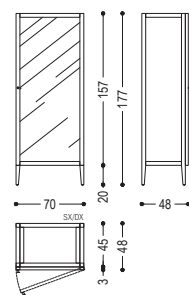

# PANDORA

GIULIANO & GABRIELE CAPPELLETTI



Mobile contenitore multifunzione in legno listellare dotato di ante laterali contenitive, con angolo di apertura a 180°, attrezzate con piccoli ripiani per contenere o appendere i bicchieri. Il vano centrale ospita una serie di cassetti costruiti con incastri a coda di rondine. I due vani laterali sono illuminati per mezzo di strisce a LED posizionate sulle spalle centrali, la cui accensione risulta automatica tramite sensori che si attivano all'apertura delle ante. Qui, a destra e nelle pagine a seguire: noce con nodi.

*Multifunctional sideboard in blockboard with lateral doors opening to 180°, containing small shelves that allow to store or hang glasses. The central space contains a series of drawers assembled with dove tail joints. The two lateral spaces are illuminated by LED strips along the inner sides, activated automatically via sensors when the doors are opened. In the pictures: walnut with knots, oil finish.*

*Mehrzwecksideboard aus Furnierschichtholz mit zwei seitlichen Türen, die an der Innenseite mit Regalen bzw. mit Weinglas Hängeleisten bestückt sind und einen Öffnungswinkel von 180 Grad haben. In der Mitte befinden sich drei Auszüge. Die zwei seitlichen Fächer sind mittels eingelassener LED-Lichtleisten beleuchtet und dank eines Sensors geht das Licht beim Öffnen der Türen automatisch an. In den Fotos: Nussbaum mit Knoten geölt.*

CM: L. 247/368 · P. 51,5 · H. 90,5

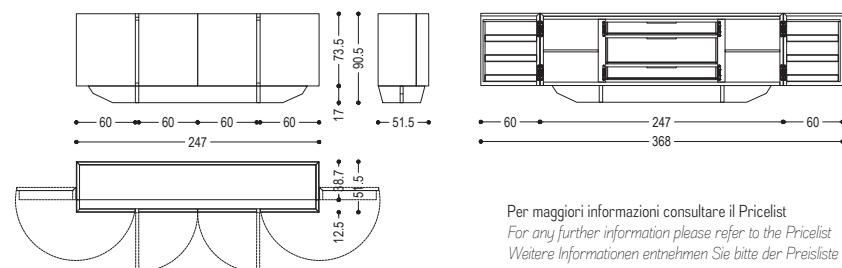







## PANDORA GLASS

GIULIANO & GABRIELE CAPPELLETTI



CM: L. 245,9 · P. 50,5 · H. 92

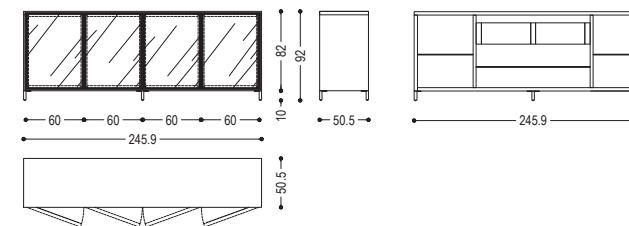

Per maggiori informazioni consultare il Pricelist  
 For any further information please refer to the Pricelist  
 Weitere Informationen entnehmen Sie bitte der Preisliste

Mobile contenitore multifunzione in legno listellare dotato di ante in vetro con struttura in alluminio. L'attrezzatura interna è progettata sulla base delle esigenze contenitive e funzionali, costituita da soli ripiani in vetro oppure con l'aggiunta di due cassetti interni in legno massello con maniglia incassata, assemblati con incastri a coda di rondine. L'interno del mobile è illuminato per mezzo di strisce a LED posizionate sulle spalle centrali, la cui accensione risulta automatica tramite sensori che si attivano all'apertura delle ante.

Qui, a sinistra e nelle pagine a seguire: noce senza nodi, finitura olio e ante vetro trasparente.

*Multifunctional storage unit in blockboard, with four glass doors with aluminum frame. Internal fittings, designed to meet storage and functional needs, include glass shelves only or, in addition, two drawers in solid wood with grooved handle, assembled with traditional dovetail joints. The inside is illuminated by LED strips along the inner sides, activated automatically via sensors when the doors are opened.*

*In the pictures: walnut without knots, oil finish, and doors in clear glass.*

*Mehrzwecksideboard aus Furnierschichtholz, mit Glastüren und Türrahmen aus Aluminium versehen. Innen ist das Sideboard funktionsbedingt mit Glasböden bzw. mit Schubladen aus Massivholz, mit Schwalbenschwanzverbindungen und Griffnuten eingerichtet. Der Innenraum ist mittels eingelassener LED-Lichtleisten beleuchtet und dank eines Sensors geht das Licht beim Öffnen der Türen automatisch an.*

*In den Fotos: Nussbaum ohne Knoten geölt und Türen aus transparentem Glas.*





## PANDORA UP SMALL

GIULIANO & GABRIELE CAPPELLETTI



CM: L. 187 · P. 51,5 · H. 75

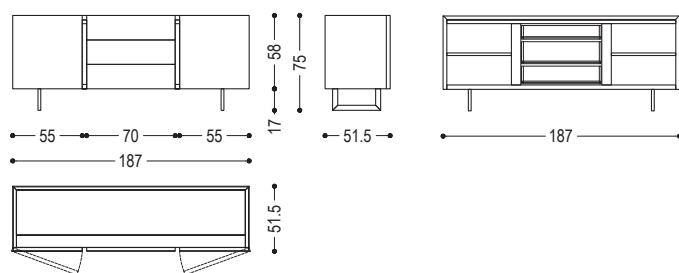

Mobile contenitore multifunzione in legno listellare con due ante laterali, disponibile anche nella versione con inserto sul top in metallo, marmo o vetro. Restyling della versione originale, prevede l'inserimento di un basamento in ferro caratterizzato da due gambe a slitta. Ante attrezzate con piccoli ripiani per contenere i bicchieri. Il vano centrale ospita una serie di cassetti assemblati con incastri a coda di rondine. I vani laterali sono illuminati per mezzo di strisce a LED posizionate sulle spalle centrali, la cui accensione risulta automatica tramite sensori che si attivano all'apertura delle ante.

Qui e a destra: noce senza nodi, finitura olio, top gres Sahara Noir e basamento ferro laccato iron dust.

*Multifunctional storage unit in blockboard with two lateral doors, available also with metal, marble or glass insert on the top. Restyling of the original version, it has an iron base characterized by two U-shaped legs. The doors contain small shelves to store glasses. The central compartment has a series of drawers assembled with dovetail joints. The two lateral spaces are illuminated by LED strips along the inner sides, activated automatically via sensors when the doors are opened.*

*In the pictures: walnut without knots, oil finish, top in stoneware Sahara Noir and iron base lacquered iron dust.*

*Mehrzwecksideboard aus Furnierschichtholz, mit zwei seitlichen Türen, optional mit Deko an der Abdeckplatte wahlweise aus Metall, Glas oder Marmor erhältlich. Eine Entwicklung der ersten Version, verfügt das Sideboard über zwei Fuß-Kufen aus Eisen. Die Türen sind an der Innenseite mit Regalen bestückt. In der Mitte befindet sich eine Reihe von Schubladen aus Massivholz, mit Schwalbenschwanzverbindungen. Die zwei seitlichen Fächern sind mittels eingelassener LED-Lichtleisten beleuchtet und dank eines Sensors geht das Licht beim Öffnen der Türen automatisch an.*

*In den Fotos: Nussbaum ohne Knoten geölt, Platte aus Feinsteinzeug Sahara Noir und Eisengestell lackiert iron dust.*

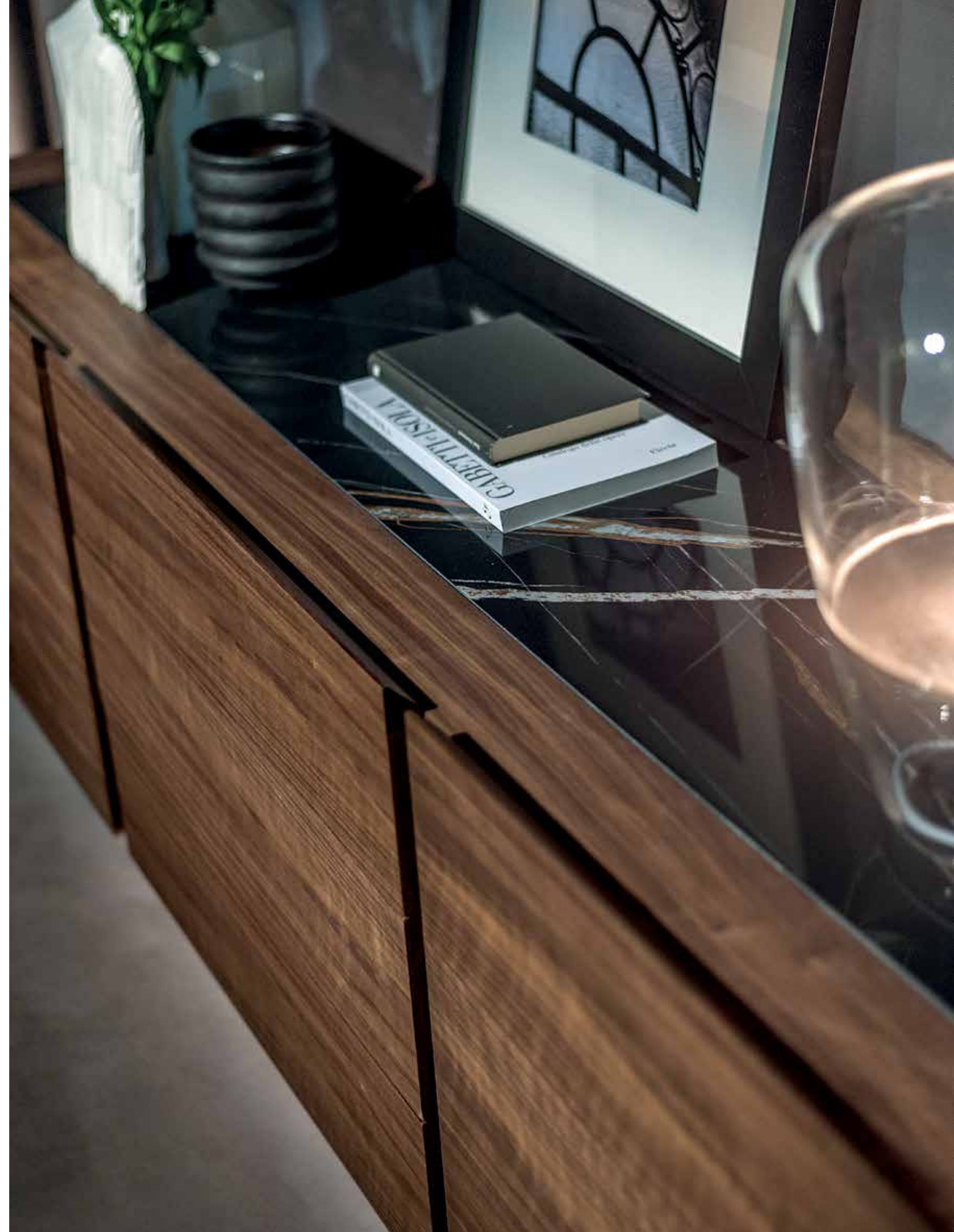



## RIALTO 2013

GIULIANO CAPPELLETTI



"FICUS" OAK +  
NATURAL IRON MATT TRANSPARENT LACQUERED



PRINTED GLASS (SAHARA NOIR) +  
WALNUT



TOTAL BLACK PIGMENTED OAK +  
NATURAL IRON MATT TRANSPARENT LACQUERED



VINTAGE OAK + AGED COPPER IRON EFFECT



WALNUT VENEER +  
NATURAL IRON MATT TRANSPARENT LACQUERED

CM: L. 64,8 · P. 46,3 · H. 138,5

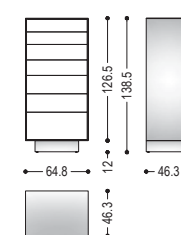

Cassettiera in legno massello e listellare, racchiusa da cornice in ferro o legno, caratterizzata da cassetti assemblati con incastrati a coda di rondine.

Nella pagina sinistra: struttura in ferro laccato trasparente opaco e frontali in rovere senza nodi vintage.

*Chest of drawers in solid wood and blockboard, with iron or wooden frame, characterized by drawers assembled with dovetail joints.*

*On the left: natural iron structure matt transparent lacquered and fronts in vintage oak without knots.*

*Schubkastenkommode aus Massiv- und Furnierschichtholz, mit Außenrahmen wahlweise aus Holz oder Metall erhältlich. Die Kommode verfügt über Schubladen mit Schwalbenschwanzverbindungen.*

*Links: Struktur aus Natureisen matt transparent lackiert und Fronten aus Eiche ohne Knoten Vintage.*



## RIALTO FLY · RIALTO FLY OPEN

GIULIANO CAPPELLETTI

Credenza in legno massello e multistrato, racchiusa da cornice in ferro o legno, caratterizzata da cassetti assemblati con incastri a coda di rondine e ante. Due sottili gambe in ferro rialzano il mobile da terra. La versione Rialto Fly Open è caratterizzata da un vano a giorno. L'interno dei vani laterali è illuminato per mezzo di strisce a LED posizionate sulle spalle centrali, la cui accensione risulta automatica tramite sensori che si attivano all'apertura delle ante; nel vano a giorno la striscia a LED è invece attivata tramite un sensore a sfioro a vista.

Qui: frontali rovere senza nodi vintage - noce senza nodi, finitura olio e struttura ferro laccato irondust. A sinistra: noce senza nodi, finitura olio e struttura ferro laccato irondust.

*Sideboard in solid wood and blockboard, with iron or wooden frame, characterized by drawers assembled with dovetail joints and doors. Two fine iron legs raise it from the ground. The version Rialto Fly Open is characterized by an open module combined with doors and a drawer with dovetail joints. Inside the doors the spaces are illuminated LED strips along the sides, activated when the doors are opened sensor, while inside the open module the LED strips are activated via a touch sensor.*

*On this page: vintage oak without knots - walnut with knots, oil finish and iron structure lacquered irondust. On the left: walnut with knots, oil finish and iron structure lacquered irondust.*

*Sideboard aus Massiv- und Furnierschichtholz, mit Außenrahmen wahlweise aus Holz oder Metall erhältlich. Dies Sideboard verfügt über Drehtüren und Schubladen mit Schwalbenschwanzverbindungen. Der Möbelkorpus steht auf dünnen Eisen-Fußwangen. Die Version Rialto Fly Open hat ein offenes Modul neben Türen und einer Schublade mit Schwalbenschwanzverbindungen. Die seitlichen Fächer sind mittels eingelassener LED-Lichtleisten beleuchtet und dank eines Sensors geht das Licht beim Öffnen der Türen automatisch an. Anders wird das Licht im offenen Fach durch einen Berührsensor ein- und ausgeschaltet.*

*Auf dieser Seite: Eiche ohne Knoten Vintage - Nussbaum mit Knoten geölt und Eisenstruktur lackiert irondust. Links: Nussbaum mit Knoten geölt und Eisenstruktur lackiert irondust.*

RIALTO\_FLY METAL  
CM: L. 220 · P. 45 · H. 75

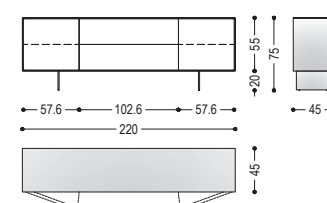

RIALTO\_FLY OPEN METAL  
CM: L. 220 · P. 45 · H. 75

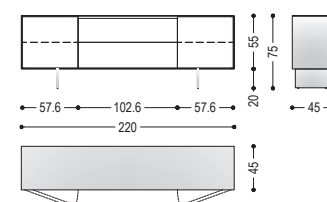



## SIPARIO 2011

C.R.&S. RIVA1920

Sistema componibile realizzato in legno massello e multistrato, caratterizzato da vari moduli componibili tra loro.

Qui: moduli base noce senza nodi, finitura olio. Nella pagina sinistra: moduli base rovere senza nodi, finitura cera.

*Modular system in solid wood and blockboard, characterized by different modules to be combined with each other.*

*On this page: base units in walnut without knots, oil finish. On the left: base units in oak without knots, wax finish.*

*Baukastensystem aus Massiv-und Furnierschichtholz, das sich durch die Zusammenstellung von mehreren Elementen charakterisiert.*

*Auf dieser Seite: Module in Nussbaum ohne Knoten geölt. Links: Module in Eiche ohne Knoten gewachst.*

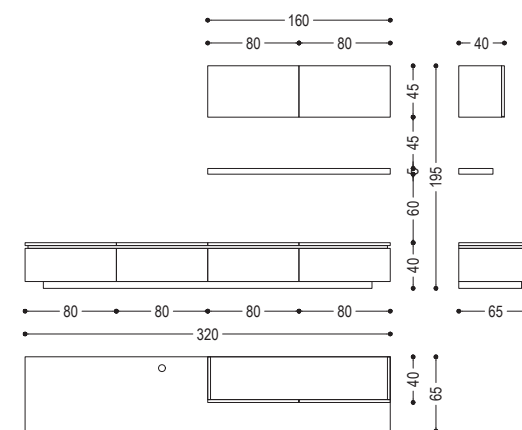

Per maggiori informazioni consultare il Pricelist  
 For any further information please refer to the Pricelist  
 Weitere Informationen entnehmen Sie bitte der Preisliste





## VITREA

GIULIANO & GABRIELE CAPPELLETTI

Mobile contenitore multifunzione in legno listellare dotato di ante in vetro con struttura in legno, con angolo di apertura a 180°, in abbinata ad un basamento in ferro caratterizzato da due gambe a slitta. L'attrezzatura e i complementi interni sono progettati sulla base delle esigenze contenitive e funzionali. L'interno del mobile è illuminato per mezzo di strisce a LED posizionate sulle spalle nel modello VITREA 1 e nello schienale sul retro dei ripiani nel modello VITREA 2; l'accensione risulta automatica tramite sensori che si attivano con il passaggio della mano.

Qui: noce senza nodi, finitura olio. A sinistra e a seguire: rovere con nodi tabacco.

*Multifunctional storage unit in blockboard, with glass doors with wooden frame, opening to 180°, and iron base with U-shaped legs. The unit and the interior accessories are designed to meet storage and functional needs. The inside is illuminated by LED strips along the inner sides in the model VITREA 1 and placed on the back behind the shelves in the model VITREA 2; they are activated automatically via touch sensors by the passage of the hand.*

*On this page: walnut without knots, oil finish. On the left and the following pages: tobacco oak with knots.*

*Mehrzweckschrank aus Furnierschichtholz, mit um 180 Grad drehbaren Glastüren und Türrahmen aus Holz versehen. Der Schrankkorpus steht auf Fuß-Kufen aus Eisen. Der Innenraum ist mittels in der Schrank-Seitenwänden (VITREA 1) bzw. in der Rückwand (VITREA 2) eingelassener LED-Lichtleisten beleuchtet und das Licht wird durch einen Berührungssensor in der Außenseitenwand ein- und ausgeschaltet.*

*Auf dieser Seite: Nussbaum ohne Knoten geölt. Links und auf den nächsten Seiten: Eiche mit Knoten Tabacco.*

CM: L. 120/240,4 · P. 53,2 · H. 180

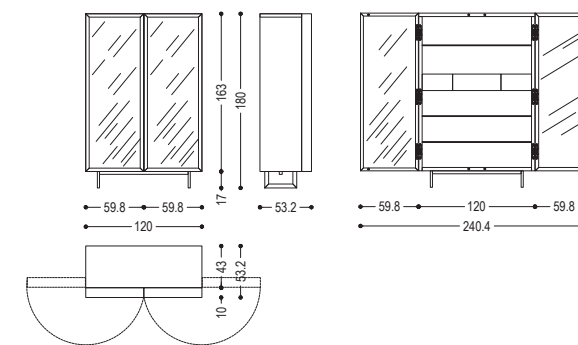







LIBRERIE · BOOKSHELVES · REGALSYSTEME



**BIBLIO** 224-225



**BOOKSHELF** 226-227



**CRAZY** 228-229



**FREEDOM** 230-233



**PASSWORD** 234-235



**PIANO DESIGN BOOKSHELF** 236-237



**PILLAR** 238-239



**TRITOK** 240-241



**WALLSTREET** 242-243

# BIBLIO

MICHELE DE LUCCHI



CM: L. 256 · P. 41,5 · H. 239

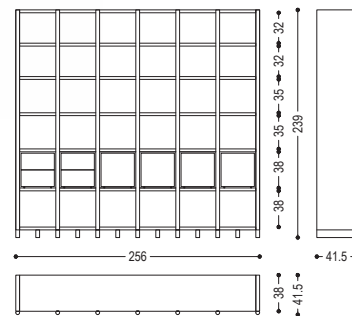

Per maggiori informazioni consultare il Pricelist  
For any further information please refer to the Pricelist  
Weitere Informationen entnehmen Sie bitte der Preisliste

Libreria realizzata in legno massello e listellare, caratterizzata da un sistema di spalle e ripiani modulari con zoccolo d'appoggio. Flessibile sulla base delle esigenze d'arredo vede la possibilità di inserimento di ante a battente e cassetti assemblati con incastri a coda di rondine e dotati di sistema di apertura push-pull.

Qui e nella pagina di destra: noce senza nodi, finitura olio.

*Bookshelf in solid wood and multilayer, characterized by a system of sides and modular shelves with plinth. It can be fitted according to different furnishing needs and can be also supplied with double doors and drawers assembled with dovetail joints, equipped with push-pull opening system.*

*In the pictures: walnut without knots, oil finish.*

*Bücherregal aus Massiv- und Furnierschichtholz, gekennzeichnet durch ein System von Seiten und Einlegeböden mit Sockel. Es kann an verschiedene Einrichtungsbedürfnisse angepasst werden und kann mit Doppeltüren und Schubladen mit Schwalbenschwanzverbindung und mit Push-Pull-Öffnungssystem geliefert werden.*

*In den Fotos: Nussbaum ohne Knoten geölt.*



# BOOKSHELF

DAVID CHIPPERFIELD

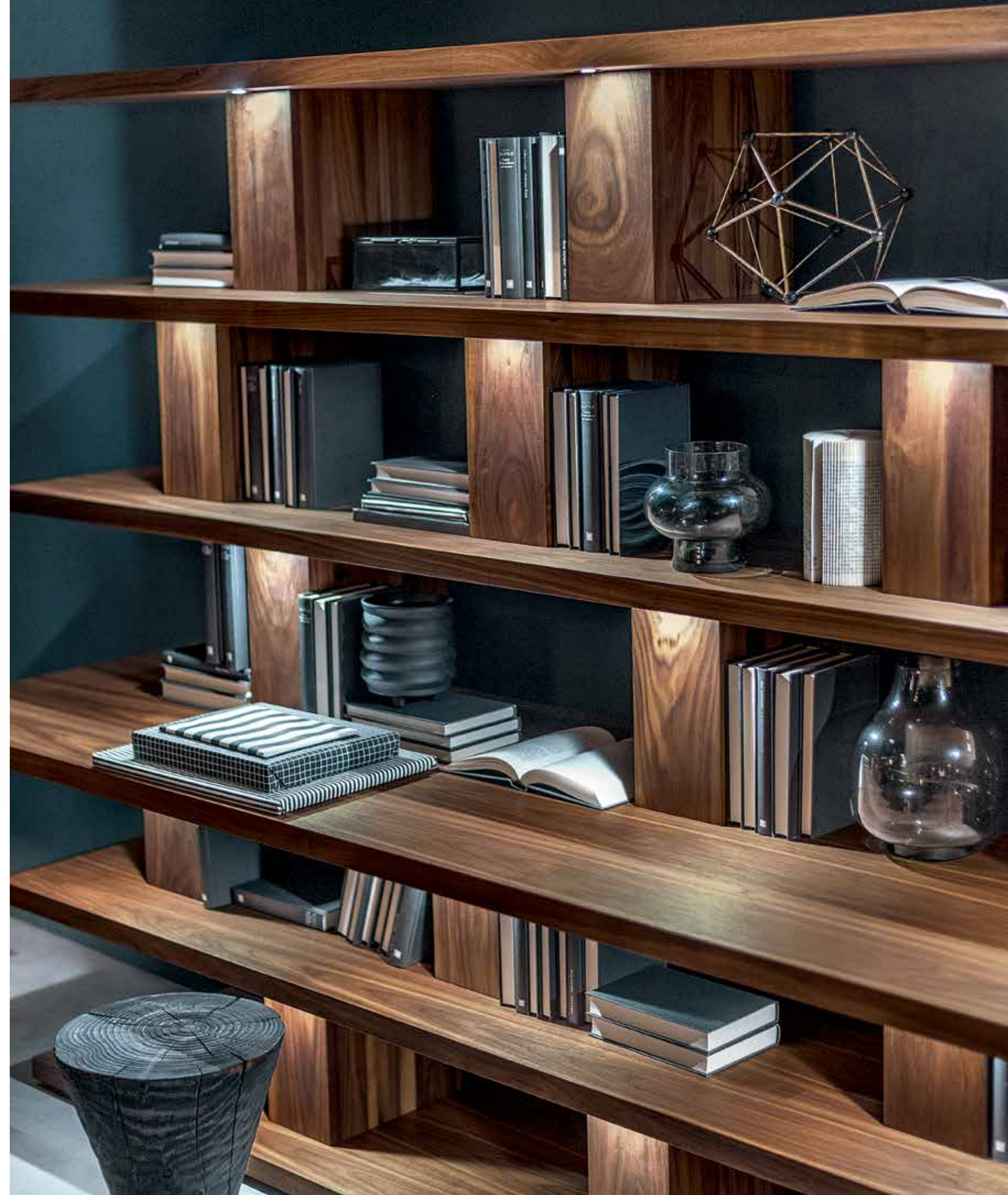

Libreria realizzata interamente in legno massello, si caratterizza per le differenti profondità delle mensole e per il posizionamento asimmetrico dei distanziali. Il terzo ripiano, più sporgente rispetto agli altri, si presta ad essere utilizzato come piano d'appoggio/scrivitoio. Possibilità di utilizzo come elemento divisorio all'interno dell'ambiente. A richiesta realizzabile con ripiani e distanziali in listellare impiallacciato (Bookshelf 2019).

Qui e nella pagina destra: noce senza nodi, finitura olio.

*Bookshelf completely in solid wood. Shelving with different depths and asymmetrical positioning of the spacers. The third shelf protrudes more than the others and can be used as a support surface/writing desk. It can be used as room divider in open spaces. Upon request it can be produced in multilayer veneered (Bookshelf 2019).*

*In the pictures: walnut without knots, oil finish.*

*Regalsystem völlig aus Massivholz. Regalböden mit unterschiedlichen Tiefen und Abständen asymmetrisch gestellt. Das dritte Regalboden ist tiefer und kann als Schreibtisch verwendet werden. Das Regalsystem kann auch als Raumteiler dienen. Auf Anfrage mit Regalböden und Abständen aus Furnierschichtholz erhältlich (Bookshelf 2019).*

*In den Fotos: Nussbaum ohne Knoten geölt.*

CM: L. 240/280/320 · P. 80 · H. 175,5

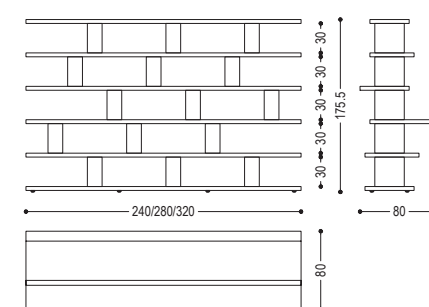



## CRAZY

C.R.&S. RIVA1920



Libreria realizzata in legno massello, caratterizzata da una sottile cornice in ferro e mensole con bordi anteriori naturali che si intersecano e fuoriescono dalla struttura.  
 Qui: mensole rovere senza nodi, finitura cera e cornice in ferro laccato irondust. Nella pagina sinistra: mensole noce con nodi, finitura olio e cornice in ferro laccato irondust.

*Bookshelf in solid wood with a fine iron frame and shelving with natural edges that intersect and protrude from the structure.*

*On this page: shelves in oak without knots, wax finish, and iron frame lacquered irondust. On the left: shelves in walnut with knots, oil finish, and iron frame lacquered irondust.*

*Regalsystem aus Massivholz mit einem dünnen Rahmen aus Eisen und Einlegeböden mit Naturkanten. Wandbefestigung der Einlegeböden und der Struktur notwendig.*

*Auf dieser Seite: Regalböden aus Eiche ohne Knoten gewachst und Rahmen aus Eisen lackiert irondust. Links: Regalböden aus Nussbaum mit Knoten geölt und Rahmen aus Eisen lackiert irondust.*

CM: L. 120/160/180/200/220/240/280 · P. 37 · H. 200

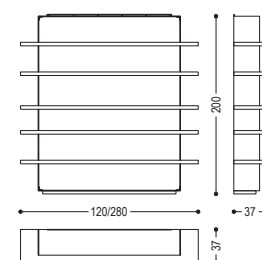



## FREEDOM

C.R.&S. RIVA1920



Libreria realizzata in legno massello, costituita da moduli componibili impilabili ed accostabili tra loro attraverso specifica ferramenta di montaggio. Incastri a coda di rondine caratterizzano ogni elemento. Flessibile sulla base delle esigenze d'arredo vede la possibilità di inserimento di schienali, ante e cassetti assemblati con incastri a coda di rondine e dotati di sistema di apertura push-pull. Disponibile con vano porta TV fisso o girevole, dotato di sistema passacavi. A richiesta è disponibile con elementi "bifacciali" e può essere utilizzata come elemento divisorio all'interno dell'ambiente.

Qui e nella pagina sinistra: noce senza nodi, finitura olio.

*Bookshelf made of solid wood, made up of modular components that can be stacked and pulled together using special mounting hardware. The dovetail joint of each element is the main feature. Potential for flexible design, including the insertion of backs, doors and drawers assembled with dovetail joints with push-pull opening system. Available with fixed or rotating TV panel, with cable housing. Available with "double face" elements, can be used as a divisor inside the space.*

*In the pictures: walnut without knots, oil finish.*

*Regalsystem aus Massivholz mit unabhängigen Modulen, die gestapelt und nebeneinander mittels Sonderbeschläge gestellt werden. Elemente mit Schwalbenschwanzverbindung. Auf Anfrage können Rückwände, Türen und Schubladen mit Push-Pull System eingefügt werden. Tv-Element mit drehbarer oder festiger Rückwand und Kabelführung erhältlich. Das Regalsystem kann auch als Raumteiler mit zweiseitigen Elementen dienen.*

*In den Fotos: Nussbaum ohne Knoten geölt.*

FREEDOM-PROJECT-5  
CM: L. 267,8 · P. 30/38 · H. 192,2

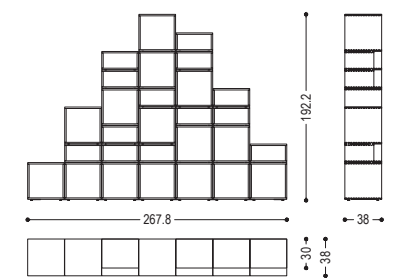

Per maggiori informazioni consultare il Pricelist  
For any further information please refer to the Pricelist  
Weitere Informationen entnehmen Sie bitte der Preisliste

Qui: noce senza nodi, finitura olio.  
 A destra: rovere senza nodi, finitura  
 cera e rovere senza nodi pigmentato  
 total black.

*On this page: walnut without knots,  
 oil finish.*

*On the right: oak without knots, wax  
 finish, and total black pigmented oak  
 without knots.*

*Auf dieser Seite: Nussbaum ohne  
 Knoten geölt.*

*Rechts: Eiche ohne Knoten gewachst  
 und Eiche ohne Knoten pigmentiert  
 total black.*



FREEDOM-PROJECT-2  
 CM: L. 191,2 · P. 30/38 · H. 96,4

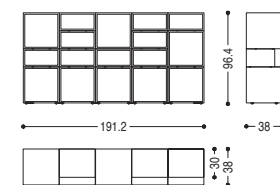

FREEDOM-PROJECT-4  
 CM: L. 152,9 · P. 30/38 · H. 230,5

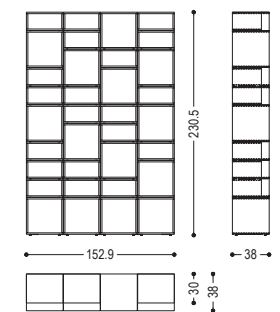

CM: L. 306,1 · P. 30/38 · H. 192,2

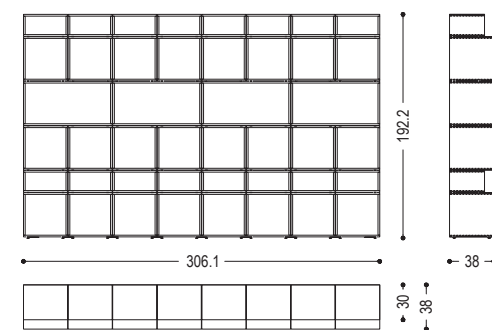

Per maggiori informazioni consultare il Pricelist  
 For any further information please refer to the Pricelist  
 Weitere Informationen entnehmen Sie bitte der Preisliste

# PASSWORD

C.R.&S. RIVA1920



CM: L. 372 · P. 38 · H. 244,5

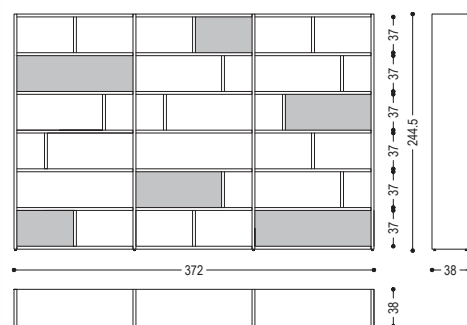

Per maggiori informazioni consultare il Pricelist  
 For any further information please refer to the Pricelist  
 Weitere Informationen entnehmen Sie bitte der Preisliste

Libreria realizzata in massello e listellare impiallacciato, caratterizzata da un sistema di spalle e ripiani modulari ed asimmetrici. Flessibile sulla base delle esigenze d'arredo vede la possibilità di inserimento di schienali, ante a ribalta e cassetti assemblati con incastri a coda di rondine e dotati di sistema di apertura push-pull e guide metalliche. A richiesta è disponibile con elementi "bifacciali" e può essere utilizzata come elemento divisorio all'interno dell'ambiente.

Qui: rovere senza nodi, finitura cera e frontali cemento beige. Nella pagina destra: noce senza nodi, finitura olio e frontali cemento nero.

*Bookshelf in solid wood and multilayer, featuring structural side panels and modular and asymmetrical shelves. It can be fitted according to different furnishing needs by including backs, flap doors and drawers assembled with dovetail joints with push-pull system. Available with "double face" elements, it can be used as room divider.*

*On this page: oak without knots, wax finish, and fronts in beige concrete finish. On the right: walnut without knots, oil finish, and fronts in black concrete finish.*

*Bücherregal aus Massivholz mit unabhängigen Seiten und asymmetrischen Regalböden. Auf Anfrage mit Rückwänden, Klapptüren und Schubladen mit Schwalbenschwanzverbindung und Push-Pull System erhältlich. Das Bücherregal kann als Raumteiler mit zweiseitigen Elementen dienen.*

*Auf dieser Seite: Eiche ohne Knoten gewachst und Fronten Ausführung Beton Farbe beige. Rechts: Nussbaum ohne Knoten geölt und Fronten Ausführung Beton Farbe schwarz.*





## PIANO DESIGN BOOKSHELF

RENZO & MATTEO PIANO



CM: L. 280 · P. 45 · H. 177

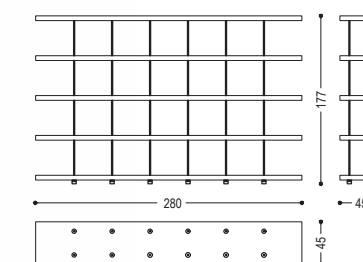

Per maggiori informazioni consultare il Pricelist  
 For any further information please refer to the Pricelist  
 Weitere Informationen entnehmen Sie bitte der Preisliste

Libreria realizzata in legno massello e listellare, caratterizzata da mensole distanziate da sottili elementi in acciaio inossidabile. Flessibile sulla base delle esigenze d'arredo vede la possibilità di inserimento di moduli con anta a battente o cassetti assemblati con incastri a coda di rondine e maniglia ad incasso laterale. A richiesta è disponibile con elementi "bifacciali" e può essere utilizzata come elemento divisorio all'interno dell'ambiente.

Qui: rovere senza nodi pigmentato bianco latte. Nella pagina sinistra: rovere senza nodi, finitura cera.

*Bookshelf in solid wood and multilayer, with shelves separated by thin stainless steel elements. It can be fitted according to different furnishing needs by inserting modules with hinged door or drawers assembled with dovetail joints and laterally recessed handle. Available with "double face" elements, it can be used as room divider.*

*On this page: white milk pigmented oak without knots. On the left: oak without knots, wax finish.*

*Regalsystem aus Massivholz und Furnierschichtholz. Zwischen den Regalböden sind dünne Trägerstangen aus Edelstahl. Auf Anfrage mit Modulen mit Tür oder mit einem oder mehreren Schubladen, mit Schwabenschwanzverbindung und seitlichen Griffmulden erhältlich. Das Regalsystem kann als Raumteiler mit zweiseitigen Elementen dienen.*

*Auf dieser Seite: Eiche ohne Knoten pigmentiert Milchweiß. Links: Eiche ohne Knoten gewachst.*





## PILLAR

C.R.&S. RIVA1920



Libreria realizzata interamente in legno massello, si caratterizza per uno sviluppo lineare a colonna con 5 differenti livelli costituiti da liste verticali spinate che si incastrano nei ripiani circolari. La base è dotata di una piastra girevole per facilità d'uso sui 360°.  
Qui e nella pagina destra: noce senza nodi, finitura olio.

*Bookshelf completely in solid wood. Linear column design with 5 different levels made of pinned vertical slats that slot in the circular shelves. The base has a rotating plate to enable 360° use.  
In the pictures: walnut without knots, oil finish.*

*Bücherregal aus Massivholz. Schlichte Säuleform mit 5 runden Regalbrettern, die sich mit senkrechten Holzleisten überschneiden. Gestell mit 360° drehbarer Bodenplatte.  
In den Fotos: Nussbaum ohne Knoten geölt.*

CM: Ø 80 · H. 218,6

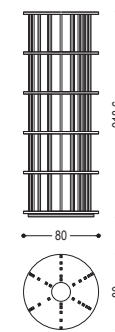

Per maggiori informazioni consultare il Pricelist  
For any further information please refer to the Pricelist  
Weitere Informationen entnehmen Sie bitte der Priceliste



# TRITOK

GIULIANO & GABRIELE CAPPELLETTI



TRITOK-MODULE W/DOORS  
CM: L. 244 · P. 45 · H. 185,5

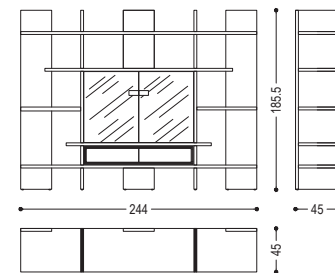

TRITOK-BOOKSHELF  
CM: L. 244 · P. 45 · H. 185,5

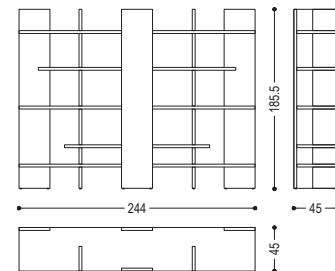

TRITOK-TV  
CM: L. 244 · P. 45 · H. 185,5

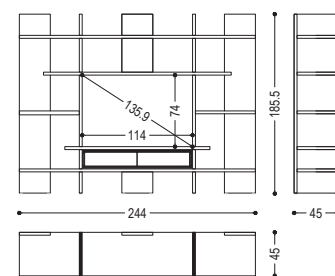

Libreria realizzata in listellare impiallacciato, caratterizzata da schienali verticali che spiccano in altezza e da una serie di ripiani di differenti lunghezze che danno movimento alla struttura. Flessibile sulla base delle esigenze d'arredo vede la possibilità di inserimento di ante, cassetti, vano TV e modulo vetrina.

Qui e a destra: noce senza nodi, finitura olio.

*Bookshelf in multilayer veneered with vertical backs that protrude in height and shelves of different lengths that give movement to the structure. It can be fitted according to different furnishing needs by including doors, drawers, TV module or cabinet version.*

*In the pictures: walnut without knots, oil finish.*

*Bücherregal aus Furnierschichtholz bestehend aus hohen Rückwänden und Einlegeböden in verschiedenen Längen. Auf Anfrage mit Holz- und Glasstüren, Schubläden, TV-Element erhältlich.*

*In den Fotos: Nussbaum ohne Knoten geölt.*





## WALLSTREET

C.R.&S. RIVA1920



CM: L. 257,5 · P. 38 · H. 248

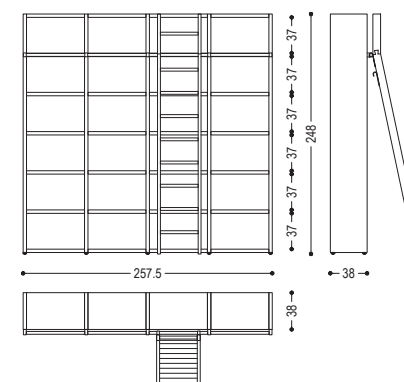

Per maggiori informazioni consultare il Pricelist  
 For any further information please refer to the Pricelist  
 Weitere Informationen entnehmen Sie bitte der Priceliste

Libreria realizzata in legno massello e listellare, caratterizzata da un sistema di spalle e ripiani modulari. Possibilità di inserimento schienali, ante e cassetti assemblati con incastri a coda di rondine.

Qui e nella pagina sinistra: rovere senza nodi, finitura cera.

*Bookshelf in solid wood and multilayer, featuring structural side panels and modular shelves. Possibility of inserting backs, doors and drawers assembled with dovetail joints.*

*In the pictures: oak without knots, wax finish.*

*Bücherregal aus Massivholz und Furnierschichtholz mit unabhängigen Seiten und Einlegeböden. Rückwände, Türen und Schubladen mit Schwalbenschwanzverbindung können eingefügt werden.*

*In den Fotos: Eiche ohne Knoten gewachst.*



SCRITTOI · *WRITING DESKS* · *SCHREIBTISCHE*



**ELLE ECRIT** 246-249



**NAVARRA** 250-251

ELLE ECRIT

JAMIE DURIE



CM: L. 180 · P. 70 · H. 76

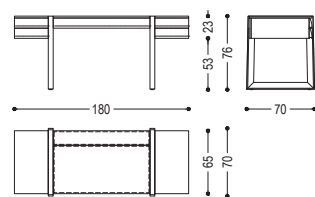

Per maggiori informazioni consultare il Pricelist  
For any further information please refer to the Pricelist  
Weitere Informationen entnehmen Sie bitte der Preisliste

Scrittoio dalle linee squadrate realizzato in multistrato impiallacciato, con cassetti assemblati con incastri a coda di rondine e gambe a slitta in legno massello. Qui, a destra e nelle pagine a seguire: noce senza nodi, finitura olio.

*Writing desk with geometric design made of veneered blockboard, drawers assembled with dovetail joints and legs in solid wood. Available in two different versions. In the pictures: walnut without knots, oil finish.*

*Schreibtisch mit geometrischem Design aus furnierter Tischlerplatte. Schubladen mit traditioneller Schwalbenschwanzverbindung. Kufengestell aus Massivholz. In zwei Varianten erhältlich.*

*In den Fotos: Nussbaum ohne Knoten geölt.*







## NAVARRA

C.R.&S. RIVA1920



Scrittoio realizzato completamente in legno massello, dotato di cassetti assemblati con incastri a coda di rondine. Disponibile con e senza alzatina, si caratterizza per l'incastro ad "X" delle gambe.

Qui e a sinistra: noce senza nodi, finitura olio.

*Writing desk made completely from solid wood. Drawers assembled with dovetail joints. Available with or without upstand with an "X" joint for the legs.*

*In the pictures: walnut without knots, oil finish.*

*Schreibtisch komplett aus Massivholz gefertigt. Schubladen mit traditioneller Schwabenschwanzverbindung. Mit oder ohne Aufsatz erhältlich. Kennzeichen dieses Produkts ist das besondere X-Gestell.*

*In den Fotos: Nussbaum ohne Knoten geölt.*

NAVARRA 4.073  
CM: L. 130 · P. 70 · H. 75

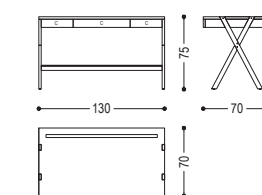

NAVARRA 4.071  
CM: L. 130 · P. 70 · H. 75/96

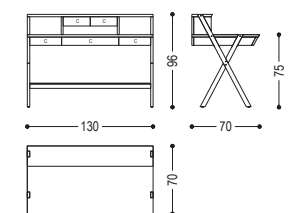

Per maggiori informazioni consultare il Pricelist  
For any further information please refer to the Pricelist  
Weitere Informationen entnehmen Sie bitte der Preisliste



POLTRONE · ARMCHAIRS · SESSEL



**BERBENA** 254-255



**BUNGALOW ARMCHAIR** 256-259



**LEA** 260-261



**MAUI SOFT** 262-263



**NOBLÉ ARMCHAIR** 264-267



**WILMA** 268-269



**YIN & YANG LOUNGE CHAIR** 270-273



## BERBENA

Poltrona imbottita con rivestimento in tessuto o pelle con cuciture a vista, caratterizzata da braccioli in legno massello che costituiscono la struttura portante della seduta.

Qui: struttura noce senza nodi, finitura olio e pelle Cristal 17. Nella pagina destra: struttura rovere senza nodi, finitura cera e pelle Utah 106.

*Padded armchair with fabric or leather upholstery and visible stitching. Armrests in solid wood are the supporting structure for the seat.*

*On this page: structure in walnut without knots, oil finish, and leather Cristal 17. On the right: structure in oak without knots, wax finish, and leather Utah 106.*

*Gepolsterter Sessel mit Stoff- oder Lederbezug erhältlich, mit dekorativen Nähten. Die Armlehnen aus Massivholz bilden die Tragstruktur dieses Sessels.*

*Auf dieser Seite: Struktur aus Nussbaum ohne Knoten geölt und Leder Cristal 17. Rechts: Struktur aus Eiche ohne Knoten gewachst und Leder Utah 106.*

CM: L. 81 · P. 100 · H. 40/75

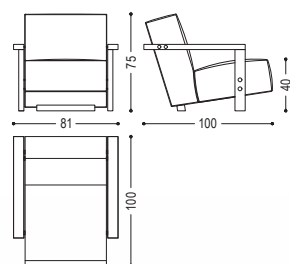

RICCARDO ARBIZZONI





## BUNGALOW ARMCHAIR

JAMIE DURIE



Poltrona imbottita con struttura realizzata in legno massello completamente tornita, assemblata e levigata a mano. Un intreccio di stringhe di pelle o tessuto caratterizza la seduta, lo schienale e i braccioli. Nella versione in tessuto previsto rinforzo strutturale all'interno del rivestimento.

Qui: struttura noce senza nodi, finitura olio e pelle Utah 102. A sinistra e a seguire: struttura noce senza nodi, finitura olio e pelle Utah 104.

*Padded armchair with structure in solid wood, turned, assembled and sanded completely by hand. An original detail are the strips of leather or fabric running both under the seat, on the backrest and on the armrests. When in fabric these strips have a structural support inside.*

*On this page: structure in walnut without knots, oil finish, and leather Utah 102. On the left and the following pages: structure in walnut without knots, oil finish, and leather Utah 104.*

*Gepolsterter Sessel mit Gestell aus Massivholz, von Hand gedrechselt, aufgebaut und geschliffen. Besonderes Detail sind die Streifen in Leder oder Stoff unter dem Sitz, auf der Rückenlehne und auf den Armlehnen. Bei der Variante in Stoff sind diese Streifen innen strukturell verstärkt.*

*Auf dieser Seite: Gestell aus Nussbaum ohne Knoten geölt und Leder Utah 102. Links und auf den nächsten Seiten: Gestell aus Nussbaum ohne Knoten geölt und Leder Utah 104.*

CM: L. 95 · P. 83 · H. 40/77

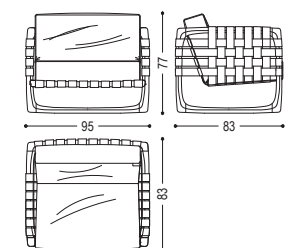





**LEA**

C.R.&S. RIVA1920



Poltrona con scocca avvolgente realizzata in poliuretano con schienale, seduta e braccioli imbottiti e rivestiti in pelle o tessuto con cuciture a vista. Dotata di base girevole in ferro. Disponibile pouf in coordinato. Qui e nella pagina sinistra: pelle Nabuk 103 e base ferro laccato RAL 9005.

*Armchair with structure in polyurethane, with back and seat covered in leather or fabric with visible stitching. With armrests and revolving iron base. Matching pouf available. In the pictures: leather Nabuk 103 and iron base lacquered RAL 9005.*

*Sessel mit umhüllender Struktur aus Polyurethan, Sitz und Rückenlehne mit Lederbezug und dekorativen Nähten. Mit Armlehnen und drehbarem Eisengestell. Mit passendem Hocker erhältlich. In den Fotos: Leder Nabuk 103 und Eisengestell lackiert RAL 9005.*

LEA-ARMCHAIR  
CM: L. 78,4 · P. 78,3 · H. 42,5/112,7

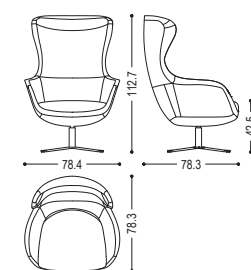

LEA-POUF  
CM: L. 56,3 · P. 51,4 · H. 43,3

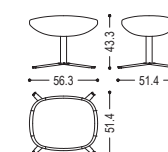

## MAUI SOFT

TERRY DWAN



Poltrona con scocca in legno multistrato imbottita e rivestita in pelle con cuciture a vista che seguono un disegno geometrico regolare. Provvista di basamento e piedi in appoggio in legno massello. Qui e nella pagina sinistra: pelle Utah 103 e basamento in noce senza nodi, finitura olio.

*Armchair with structure in padded multilayer wood and leather cover with visible stitches that trace a geometric pattern. Base composed of small feet in solid wood.*

*In the pictures: leather Utah 103 and base in walnut without knots, oil finish.*

*Sessel mit Struktur aus Multischichtholz, gepolstert und aus Leder mit dekorativen und geometrischen Nähten bezogen. Gestell bestehend aus Füßchen in Massivholz.*

*In den Fotos: Leder Utah 103 und Gestell aus Nussbaum ohne Knoten geölt.*

CM: Ø 74,3 · H. 42/59,5

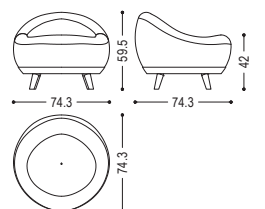

## NOBLÉ ARMCHAIR

GIULIANO & GABRIELE CAPPELLETTI

Poltrona con struttura realizzata in legno massello, dotata di schienale e comoda seduta imbottita, rivestiti in pelle o tessuto con cuciture a vista.

Qui: struttura noce senza nodi, finitura olio, schienale pelle Camoscio 26 e seduta tessuto Hallingdal 65-116. A destra e nelle pagine a seguire: struttura noce senza nodi, finitura olio, schienale pelle Camoscio 26 e seduta tessuto Maple 142.

*Armchair with solid wood structure, with backrest and comfortable padded seat, upholstered in leather or fabric with visible stitching.*

*On this page: structure in walnut without knots, oil finish, back in leather Camoscio 26 and seat in fabric Hallingdal 65-116. On the right and the following pages: structure in walnut without knots, oil finish, back in leather Camoscio 26 and seat in fabric Maple 142.*

*Sessel mit Struktur aus Massivholz, mit Rückenlehne und bequemem gepolstertem Sitz mit Bezug aus Leder oder Stoff und dekorative Nähten.*

*Auf dieser Seite: Struktur aus Nussbaum ohne Knoten geölt, Rückenlehne Camoscio 26 und Sitz Stoff Hallingdal 65-116. Rechts und auf den nächsten Seiten: Struktur aus Nussbaum ohne Knoten geölt, Rückenlehne Camoscio 26 und Sitz Stoff Maple 142.*



CM: L. 73 · P. 76 · H. 44/75

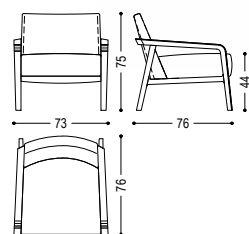





## WILMA

TERRY DWAN



Poltrona con struttura realizzata in legno massello, dotata di schienale con bordo naturale e comoda seduta imbottita e rivestita in pelle o tessuto con cuciture a vista. Disponibile nella versione con o senza braccioli.

Qui: struttura noce senza nodi, finitura olio, e pelle Utah 108. Nella pagina sinistra: struttura noce senza nodi, finitura olio, e pelle Utah 102.

*Armchair with solid wood structure. Back with natural edge and comfortable padded seat upholstered in leather or fabric with visible stitching. Available with or without armrests.*

*On this page: structure in walnut without knots, oil finish, and leather Utah 108. On the left: structure in walnut without knots, oil finish, and leather Utah 102.*

*Sessel mit Gestell aus Massivholz, Rückenlehne mit naturbelassener Oberkante. Gepolsterte Sitzfläche, Bezug aus Leder oder Stoff mit dekorativen Nähten. In den Varianten mit oder ohne Armlehnen erhältlich.*

*Auf dieser Seite: Struktur aus Nussbaum ohne Knoten geölt und Leder Utah 108. Links: Struktur aus Nussbaum ohne Knoten geölt und Leder Utah 102.*

WILMA  
CM: L. 63 · P. 71,5 · H. 41,5/68

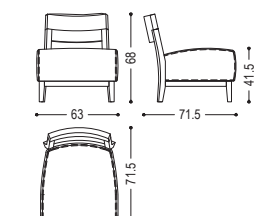

WILMA / B  
CM: L. 68 · P. 71,5 · H. 41,5/68

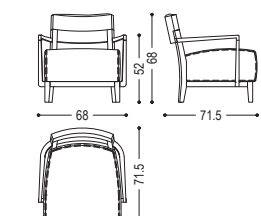





## YIN & YANG LOUNGE CHAIR

STEVE LEUNG



Poltrona dalla forma avvolgente, dotata di telaio in noce massello; completamente tornita, assemblata e levigata a mano. I curvati compongono la struttura seguendo una linea di continuità tra basamento e seduta, ricavata da un multistrato tondo e concavo rivestito in camoscio con cuciture a vista.

Qui, a sinistra e a seguire: struttura noce senza nodi, finitura olio e pelle Camoscio 27.

*Enveloping armchair with structure in solid walnut, turned, assembled and sanded completely by hand. The structure is continuous to join base and seat, which is made of round and concave multilayer, covered with leather Camoscio and with exposed stitching. In the pictures: structure in walnut without knots, oil finish, and leather Camoscio 27.*

*Eleganter bequemer Sessel mit Struktur aus Nussbaum massiv, von Hand gebaut und geschliffen. Die Struktur stützt den Sitz, der aus rundem und konkavem Multischichtholz besteht, mit Leder Camoscio und sichtbaren dekorativen Nähten.*

*In den Fotos: Struktur aus Nussbaum ohne Knoten geölt und Leder Camoscio 27.*

CM: L. 120 · P. 99 · H. 105

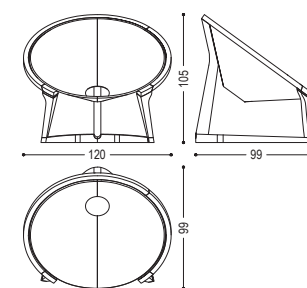



DIVANI · SOFAS · SOFAS



**FUR NATURE** 276-279



**HERITAGE** 280-281



**NUDO** 282-285



**PATMOS SOFA** 286-289



**UTAH SOFA** 290-291





## FUR NATURE

JAMIE DURIE



Divano imbottito con rivestimento in pelle o tessuto con cuciture a vista, dotato di schienale in legno listellare impiallacciato. Si caratterizza per la grande versatilità grazie a moduli componibili che permettono diverse soluzioni.

Qui, a sinistra e nelle pagine a seguire: struttura in noce senza nodi, finitura olio e pelle Utah 102.

*Padded sofa covered in leather or fabric with visible stitching. Back in veneered blockboard. Characterized by great versatility thanks to the various modular elements to create different solutions.*

*In the pictures: structure in walnut without knots, oil finish, and leather Utah 102.*

*Sofa mit Bezug aus Leder oder Stoff mit dekorativen Nähten und Rückenlehne aus furnierter Tischlerplatte. Es besteht aus mehreren Elementen, die zusammen kombiniert werden können.*

*In den Fotos: Struktur aus Nussbaum ohne Knoten geölt und Leder Utah 102.*

CM: L. 200 · P. 125,5 · H. 42/77

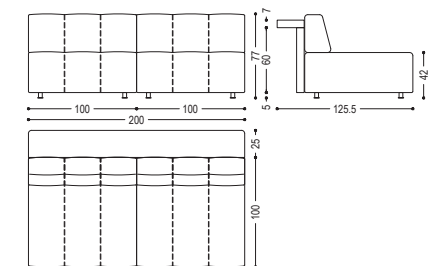

Per maggiori informazioni consultare il Pricelist  
For any further information please refer to the Pricelist  
Weitere Informationen entnehmen Sie bitte der Preisliste





# HERITAGE

GIULIANO & GABRIELE CAPPELLETTI



Programma di sedute flessibile e dinamico, capace di adattarsi ad ogni ambiente. Pianale in legno massello abbinato ad una morbida cuscineria in pelle o tessuto caratterizzata da cuciture a vista. Si caratterizza per la grande versatilità grazie a moduli componibili che permettono diverse soluzioni.

Qui e nella pagina destra: pianale noce senza nodi, finitura olio, tessuto Hallingdal 65-166, modulo senza schienale pelle Nabuk 108.

*A dynamic and flexible program, it can adapt to any environment. Wooden structure combined with soft cushions in leather or fabric with visible stitching. Characterized by great versatility thanks to the various modular elements to create different solutions.*

*In the pictures: structure in walnut without knots, oil finish, fabric Hallingdal 65-166, module without back in leather Nabuk 108.*

*Flexibles und dynamisches Sitzprogramm, das zu jedes Raum passt. Sockel aus Massivholz kombiniert mit weichen Kissen, mit Leder- oder Stoffbezug und dekorativen Nähten. Dieses Modell besteht aus mehreren Elementen, die zusammen kombiniert werden können.*

*In den Fotos: Sockel aus Nussbaum ohne Knoten geölt, Stoff Hallingdal 65-166, Modul ohne Rückenlehne in Leder Nabuk 108.*

CM: L. 400/280 · P. 100 · H. 42/61/82

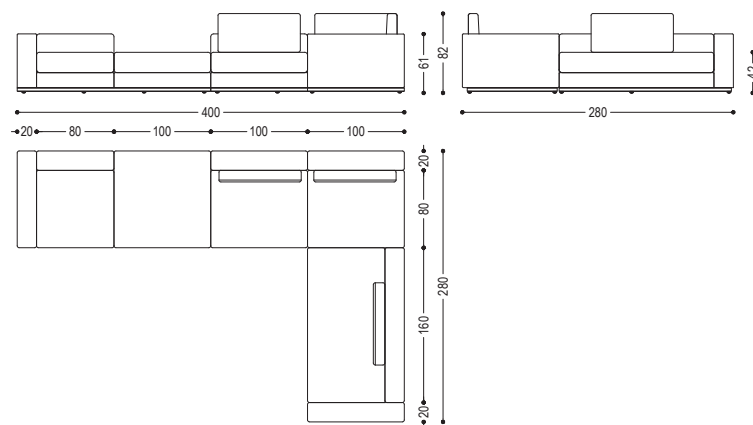

Per maggiori informazioni consultare il Pricelist  
For any further information please refer to the Pricelist  
Weitere Informationen entnehmen Sie bitte der Preisliste



## NUDO

FABRIZIO ZAPPA



Divano dalla scocca scolpita nel legno massello, che prevede l'estroffessione del legno in un moto sinuoso e continuo su schienale e fianchi, giuntati tra loro attraverso uno straordinario gioco di incastri a coda di rondine. Il basamento dalla forma arcuata accoglie grandi e morbidi cuscini in pelle o tessuto con cuciture a vista. Chiaramente ispirato ad un'opera di Amedeo Modigliani da cui prende il nome. Disponibile in due dimensioni. Qui e a sinistra: struttura in noce con nodi, finitura olio e pelle Camoscio 26. A seguire: struttura in noce con nodi, finitura olio, pelle Camoscio 27.

*Sofa with structure carved out of solid wood, with back and sides joined to each other through extraordinary dovetail joints which make the wood protrude outwardly, creating a sinuous and continuous motion. The curved base accommodates big and soft leather or fabric cushions with visible stitching. Clearly inspired by a masterpiece by Amedeo Modigliani and named after it. Available in two sizes.*

*On this page and on the left: structure in walnut with knots, oil finish, and leather Camoscio 26. On the following pages: structure in walnut with knots, oil finish, and leather Camoscio 27.*

*Sofa mit eingeschnittener Struktur aus Massivholz, Rücken- und Armlehnen durch die traditionelle Schwalbenschwanzverbindung miteinander verbunden. Kennzeichnen des Sofas ist ein Bewegungseffekt, das dadurch entsteht. Grosse und weiche Sitzkissen aus Leder oder Stoff mit dekorativen Nähten liegen auf das abgerundete Gestell. Es ist von dem Kunstwerk von Amedeo Modigliani inspiriert worden und so benannt. In zwei Maßen erhältlich.*

*Auf dieser Seite und links: Struktur aus Nussbaum mit Knoten geölt und Leder Camoscio 26. Auf den nächsten Seiten: Struktur aus Nussbaum mit Knoten geölt und Leder Camoscio 27.*



NUDO SOFA  
CM: L. 239 · P. 106 · H. 42/72

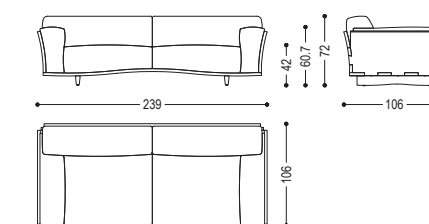

NUDO ARMCHAIR  
CM: L. 116 · P. 106 · H. 42/72

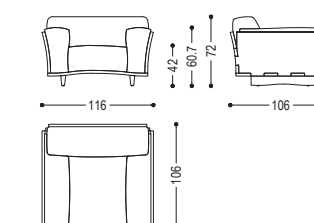





## PATMOS SOFA

TERRY DWAN



CM: L. 245 · P. 98 · H. 42/74,6/92

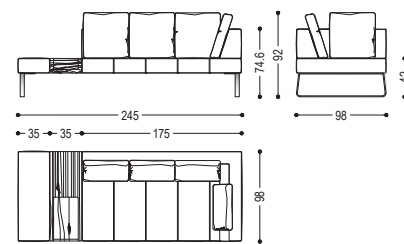

CM: L. 245 · P. 98 · H. 42/74,6

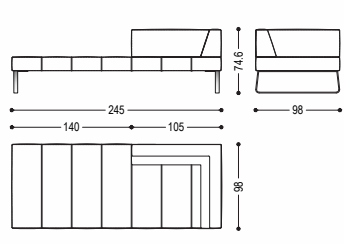

Per maggiori informazioni consultare il Pricelist  
For any further information please refer to the Pricelist  
Weitere Informationen entnehmen Sie bitte der Preisliste



Divano imbottito con rivestimento e cuscini in pelle e tessuto con cuciture a vista. Dotato di gambe a slitta in ferro, è disponibile in diverse composizioni e moduli. Alcuni elementi sono caratterizzati dalla presenza di moduli in legno di noce massello, lavorati da un blocco unico, che diventano piano d'appoggio, tavolino portariviste o portaoggetti.

Qui: pelle Cristal 18, modulo in noce con nodi, finitura olio, e base in ferro laccato iron dust - velluto Harald 792 e base in ferro laccato effetto rame antico spazzolato opaco. A destra: pelle Utah 104 e base in ferro laccato iron dust. Nelle pagine a seguire: finitura velluto Harald 792 e base in ferro laccato effetto rame antico spazzolato opaco.

*Padded sofa with upholstery and leather or fabric cushions with visible stitching. With legs in iron, available in various compositions and modular elements, some of which characterized by elements in solid wood worked from a single block that become a working, magazine or display table.*  
*On this page: leather Cristal 18, tray in walnut with knots oil finish and iron base lacquered iron dust - velvet Harald 792 and iron base lacquered aged copper matt brushed effect. On the right: leather Utah 104 and iron base lacquered iron dust. On the following pages: velvet Harald 792 and iron base lacquered aged copper matt brushed effect.*

*Sofa mit Bezug aus Leder oder Stoff mit dekorativen Nähten. Mit Gestell aus Eisen, erhältlich in verschiedenen Kombinationen, davon einige mit Massivholzablage in Nussbaum aus einem einzigen massiven Block gewonnen.*  
*Auf dieser Seite: Leder Cristal 18, Ablage aus Nussbaum mit Knoten geölt und Gestell lackiert iron dust - Samt Harald 792 und Gestell lackiert Kupfer-Effekt matt gebürstet. Rechts: Leder Utah 104 und Gestell lackiert iron dust. Auf den nächsten Seiten: Samt Harald 792 und Gestell lackiert Kupfer-Effekt matt gebürstet.*





## UTAH SOFA

C.R&S. RIVA1920

Divano con schienale, basamento e piedini d'appoggio in listellare impiallacciato, costituito da diversi moduli componibili. Dotato di rivestimento in pelle o tessuto con cuciture a vista.

Qui e nella pagina destra: noce senza nodi, finitura olio e pelle Utah 103.

*Sofa with backrest, base and feet in veneered blockboard, composed of modular elements. Upholstered with leather or fabric with visible stitching.  
In the pictures: walnut without knots, oil finish, and leather Utah 103.*

*Sofa mit Rückenlehne, Struktur und Füßchen vollständig aus furnierter Tischlerplatte, mit Bezug aus Leder oder Stoff mit dekorativen Nähten.  
Das Modell besteht aus mehreren Elementen die zusammen kombiniert werden können.  
In den Fotos: Nussbaum ohne Knoten geölt und Leder Utah 103.*

CM: L. 280 · P. 93 · H. 42/90

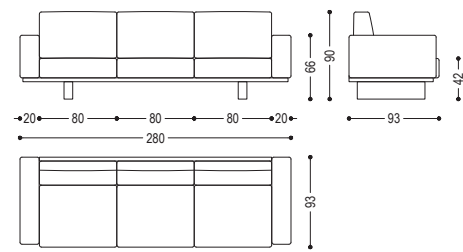

Per maggiori informazioni consultare il Pricelist  
For any further information please refer to the Pricelist  
Weitere Informationen entnehmen Sie bitte der Preisliste





FINITURE  
*FINISHES*  
*AUSFÜHRUNGEN*

# LEGNO · WOOD · HOLZ

CATEGORIE · CATEGORIES · KATEGORIEN

A1



NOCE SENZA NODI  
WALNUT WITHOUT KNOTS  
NUSSBAUM OHNE KNOTEN



NOCE CON NODI  
WALNUT WITH KNOTS  
NUSSBAUM MIT KNOTEN



OLMO  
ELM  
ULME

A2



ROVERE SENZA NODI  
OAK WITHOUT KNOTS  
EICHE OHNE KNOTEN



ROVERE CON NODI  
OAK WITH KNOTS  
EICHE MIT KNOTEN



CILIEGIO  
CHERRY  
KIRSCHBAUM



ACERO  
MAPLE  
AHORN

A3



ROVERE CON/SENZA NODI SBIANCATO \*  
WHITENED OAK WITH/WITHOUT KNOTS \*  
EICHE MIT/OHNE KNOTEN GEWEISST \*



ROVERE CON/SENZA NODI MYSTIC BLACK \*  
MYSTIC BLACK OAK WITH/WITHOUT KNOTS \*  
EICHE MIT/OHNE KNOTEN MYSTIC BLACK \*



ROVERE CON/SENZA NODI VINTAGE \*  
VINTAGE OAK WITH/WITHOUT KNOTS \*  
EICHE MIT/OHNE KNOTEN VINTAGE \*



ROVERE CON/SENZA NODI NEUTRO \*  
NEUTRO OAK WITH/WITHOUT KNOTS \*  
EICHE MIT/OHNE KNOTEN NEUTRO \*

\*N.B.: L'immagine rappresenta la versione senza nodi · N.B.:The picture represents the version without knots · N.B.: im Bild Version ohne Knoten

A4



ROVERE CON/SENZA NODI PIGMENTATO GRIGIO CENERE \*  
ASH GREY PIGMENTED OAK WITH/WITHOUT KNOTS \*  
EICHE MIT/OHNE KNOTEN GRAU ASCHIGE PIGMENTIERT \*



ROVERE SENZA NODI PIGMENTATO BIANCO LATTE \*  
WHITE MILK PIGMENTED OAK WITH/WITHOUT KNOTS \*  
EICHE MIT/OHNE KNOTEN MILCHWEISS PIGMENTIERT \*



ROVERE SENZA NODI PIGMENTATO TOTAL BLACK \*  
TOTAL BLACK PIGMENTED OAK WITH/WITHOUT KNOTS \*  
EICHE MIT/OHNE KNOTEN TOTAL BLACK PIGMENTIERT \*

\*N.B.: L'immagine rappresenta la versione senza nodi · N.B.:The picture represents the version without knots · N.B.: im Bild Version ohne Knoten

A5



ROVERE FIAMMATO LONDON  
FLAMED LONDON OAK  
EICHE LONDON (FLAMMIGE MASERUNG)



ROVERE CON NODI VULCANO  
VULCANO OAK WITH KNOTS  
EICHE MIT KNOTEN VULCANO



ROVERE CON NODI TABACCO  
TABACCO OAK WITH KNOTS  
EICHE MIT KNOTEN TABACCO

A6



BRICCOLA

A7



CEDRO  
CEDAR  
ZEDER

A8

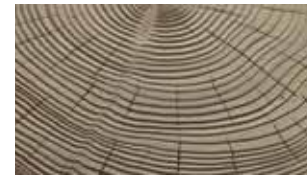

CEDRO SABBBIATO  
SANDBLASTED CEDAR  
ZEDER SANDGESTRAHLT

A9



CEDRO FINITURA CONTRACT  
CEDAR CONTRACT FINISH  
ZEDER CONTRACT



CEDRO VULCANO  
VULCANO CEDAR  
ZEDER VULCANO

A10



KAURI

A11



TEAK

# FERRO · IRON · EISEN

CATEGORIE · CATEGORIES · KATEGORIEN

B1



FERRO NATURALE OLIO  
NATURAL IRON, OILED  
NATUREISEN GEÖLT

B2

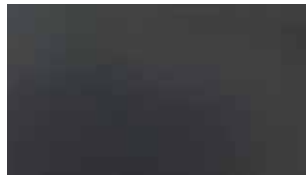

FERRO LACCATO TRASPARENTE OPACO  
NATURAL IRON MATT TRANSPARENT LACQUERED  
EISEN MATT TRANSPARENT LACKIERT



RAL 7037 - GRIGIO POLVERE  
RAL 7037 - DUSTY GREY  
RAL 7037 - STAUBGRAU

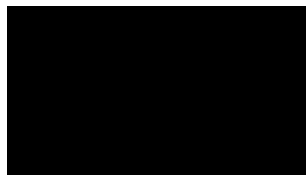

RAL 9005 - NERO INTENSO  
RAL 9005 - JET BLACK  
RAL 9005 - TIEFSCHWARZ

B3



FERRO LACCATO EFFETTO OSSIDATO  
LACQUERED IRON OXIDISED EFFECT  
EISEN LACKIERT, EFFEKT OXIDIERT



FERRO LACCATO EFFETTO TITANIO SPAZZOLATO OPACO  
LACQUERED IRON TITANIUM MATT BRUSHED EFFECT  
EISEN LACKIERT, TITAN-EFFEKT MATT GEBÜRSTET



FERRO LACCATO IRONDUST  
IRONDUST LACQUERED IRON  
EISEN IRONDUST LACKIERT

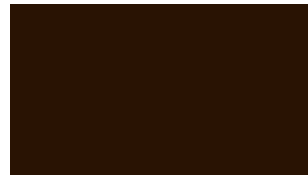

RAL 8019 - MARRONE GRIGIASTRO  
RAL 8019 - GREY BROWN  
RAL 8019 - GRAUBRAUN



RAL 9010 - BIANCO PURO  
RAL 9010 - PURE WHITE  
RAL 9010 - REINWEISS



RAL 3020 - ROSSO TRAFFICO  
RAL 3020 - TRAFFIC RED  
RAL 3020 - VERKEHRSROT

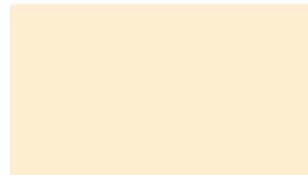

RAL 9001 - BIANCO CREMA  
RAL 9001 - CREAM WHITE  
RAL 9001 - CREMEWEISS

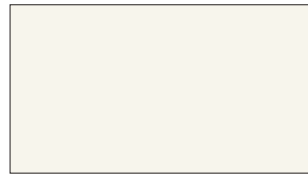

RAL 9016 - BIANCO TRAFFICO  
RAL 9016 - TRAFFIC WHITE  
RAL 9016 - VERKEHRSWEISS



RAL 7035 - GRIGIO LUCE  
RAL 7035 - LIGHT GREY  
RAL 7035 - LICHTGRAU

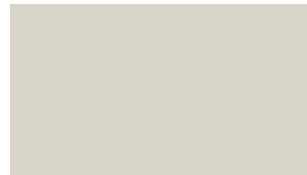

RAL 9002 - BIANCO GRIGIASTRO  
RAL 9002 - GREY WHITE  
RAL 9002 - GRAUWEISS



RAL 1013 - BIANCO PERLA  
RAL 1013 - OYSTER WHITE  
RAL 1013 - PERLWEISS



FERRO LACCATO EFFETTO BRONZO SPAZZOLATO OPACO  
LACQUERED IRON AGED COPPER MATT BRUSHED  
EFFECT  
EISEN LACKIERT, BRONZE-EFFEKT MATT GEBÜRSTET



FERRO LACCATO EFFETTO ACCIAIO SPAZZOLATO OPACO  
LACQUERED IRON STAINLESS STEEL MATT BRUSHED  
EFFECT  
EISEN LACKIERT, EDELSTAHL-EFFEKT MATT GEBÜRSTET

# CEMENTO · CONCRETE · BETON

CATEGORIE · CATEGORIES · KATEGORIEN

C



CEMENTO BEIGE  
CONCRETE BEIGE  
BETON BEIGE



CEMENTO GRIGIO MEDIO  
CONCRETE MEDIUM GREY  
BETON MITTELGRAU



CEMENTO GRIGIO  
CONCRETE GREY  
BETON GRAU



CEMENTO NERO  
CONCRETE BLACK  
BETON SCHWARZ

# PELLE / TESSUTO · LEATHER / FABRIC · LEDER/STOFFE

CATEGORIE · CATEGORIES · KATEGORIEN

TESSUTO CANVAS · FABRIC CANVAS · STOFF CANVAS



114

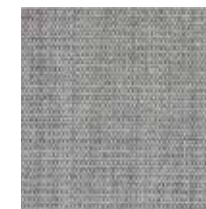

124



134



154

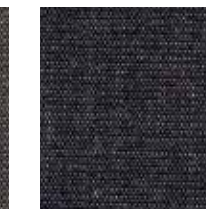

174

TESSUTO DIVINA MELANGE 2 · FABRIC DIVINA MELANGE 2 · STOFF DIVINA MELANGE 2



120

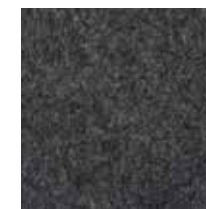

170

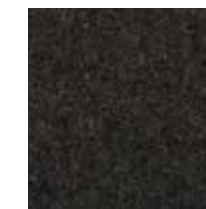

180



220

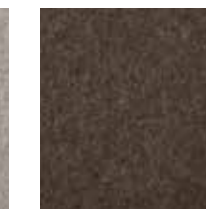

260

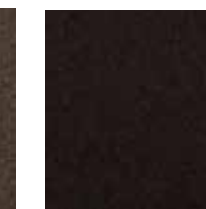

280

TESSUTO HALLINGDAL 65 · FABRIC HALLINGDAL 65 · STOFF HALLINGDAL 65

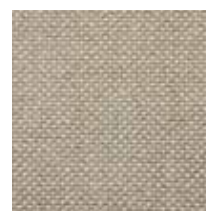

103



116



130

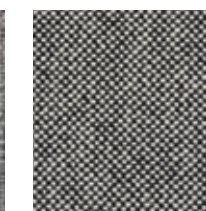

166



180

D1

VELLUTO HARALD · VELVET HARALD · SAMT HARALD

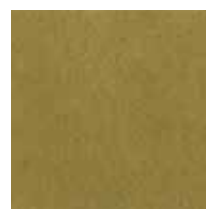

443



512

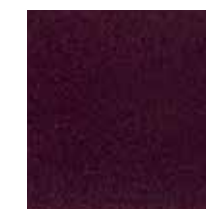

582



552

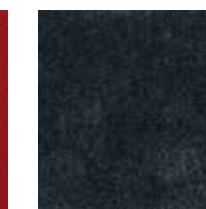

182

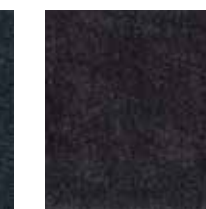

283

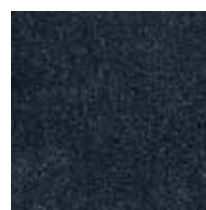

982



242

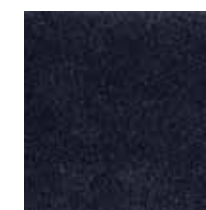

792

TESSUTO MAPLE · FABRIC MAPLE · STOFF MAPLE

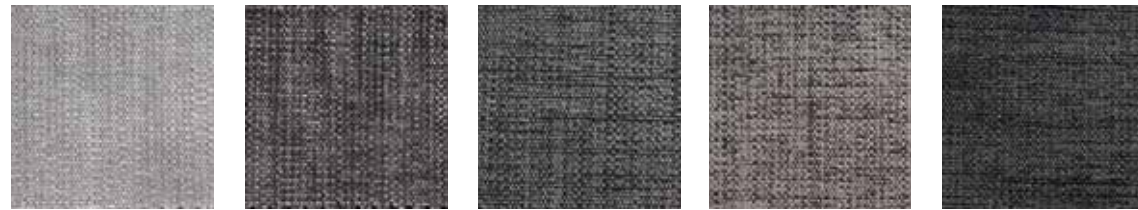

112 132 142 162 192

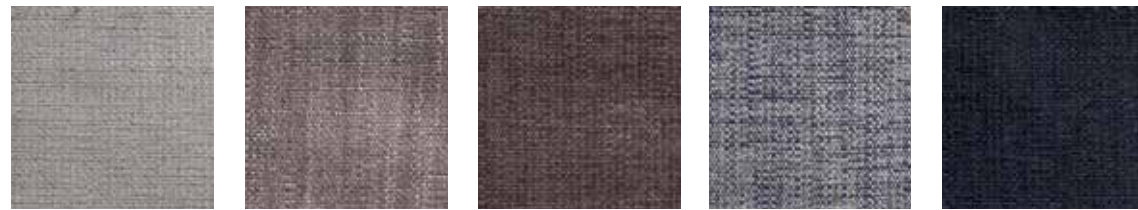

222 232 362 742 792

D2

PELLE CAMOSCIO · LEATHER CAMOSCIO · LEDER CAMOSCIO



1 10 11 26 27



28 31

D3

PELLE CRISTAL · LEATHER CRISTAL · LEDER CRISTAL



18 70 37 13 65

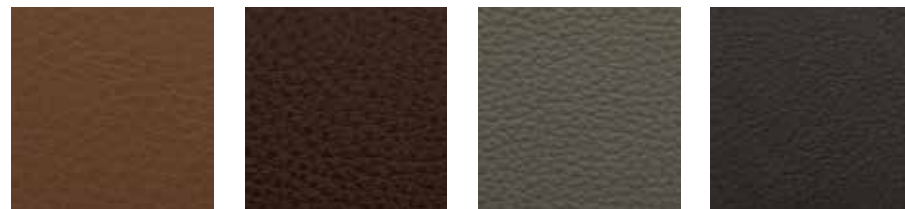

49 17 51 14

PELLE NABUK · LEATHER NABUK · LEDER NABUK



101 102 103 104 105



106 107 108 109

D4

PELLE UTAH · LEATHER UTAH · LEDER UTAH



101 102 103 104 105



106 107 108

CUOIO OLIMPIA · LEATHER OLIMPIA · KERNLEDER OLIMPIA



002 003 008 009 010

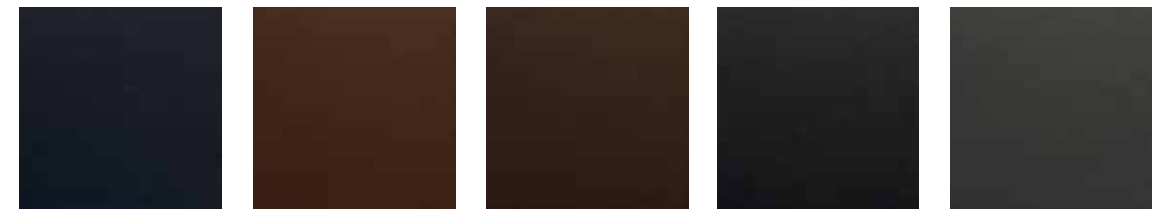

012 013 015 017 018

D5

TESSUTO OUTDOOR PATIO · OUTDOOR FABRIC PATIO · OUTDOOR-STOFF PATIO

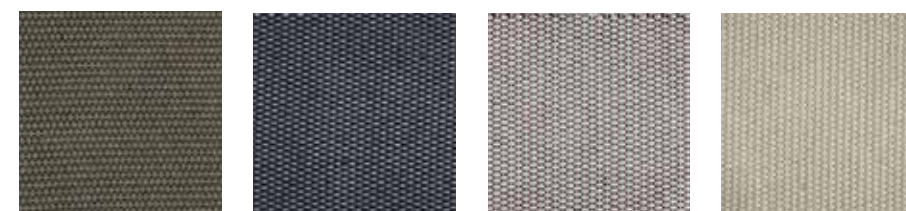

150 170 220 230

## VETRO · GLASS · GLAS

CATEGORIE · CATEGORIES · KATEGORIEN

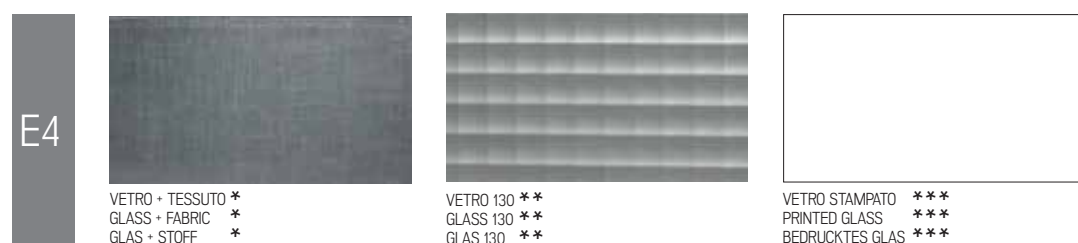
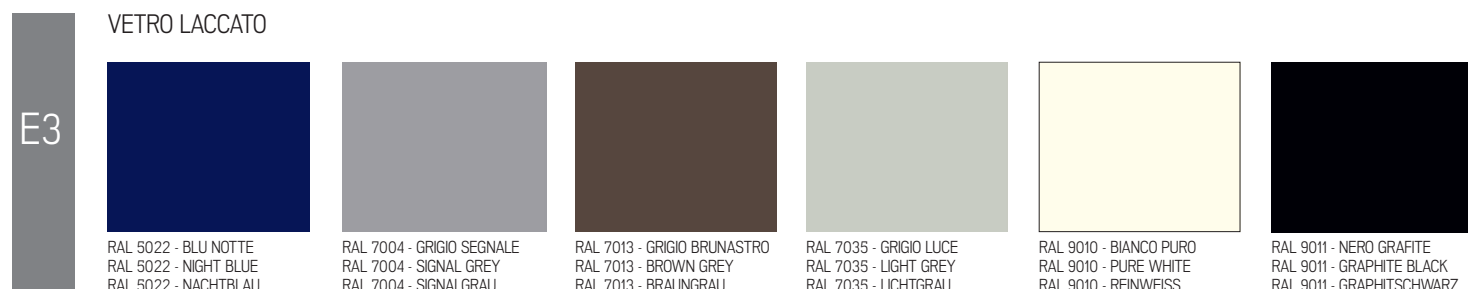
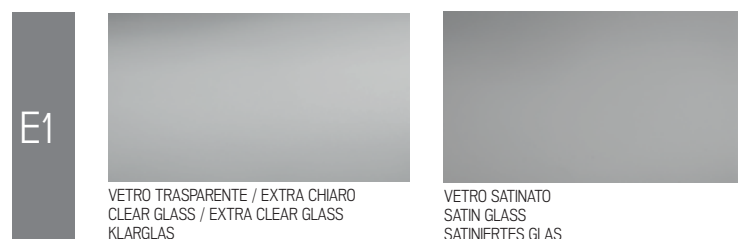

\***N.B.:** Immagine rappresentata è indicativa. Disponibile con i tessuti a campionario Canvas, Divina Melange 2, Hallingdal 65 e Maple.

**N.B.:** the picture is indicative. Available with fabrics of the collection: Canvas, Divina Melange 2, Hallingdal 65 and Maple.

**N.B.:** Abbildung dient lediglich Illustrationszwecken. Mit Stoff Canvas, Divina Melange 2, Hallingdal 65 und Maple erhältlich.

\*\***N.B.:** quadrettato in rilievo e retro laccato.

**N.B.:** sandblasted relief squared pattern and lacquered.

**N.B.:** karirtes Glas, satiniert und hinterlackiert.

\*\*\***N.B.:** la stampa su vetro prevede la possibilità di utilizzare qualsiasi immagine a scelta del cliente, previa approvazione da parte dell'ufficio commerciale in merito a fattibilità e prezzo.

\*\*\***N.B.:** possibility of printing any picture on the glass only after approval of feasibility and pricing by Riva sales department.

\*\*\***N.B.:** Druck auf Glas bietet die Möglichkeit sich selber Motiven auszusuchen (nach vorheriger Prüfung mit unserem Verkaufsabteilung hinsichtlich Machbarkeit und Kosten).

## ALTRI MATERIALI · OTHER MATERIALS · WEITERE MATERIALIEN

CATEGORIE · CATEGORIES · KATEGORIEN

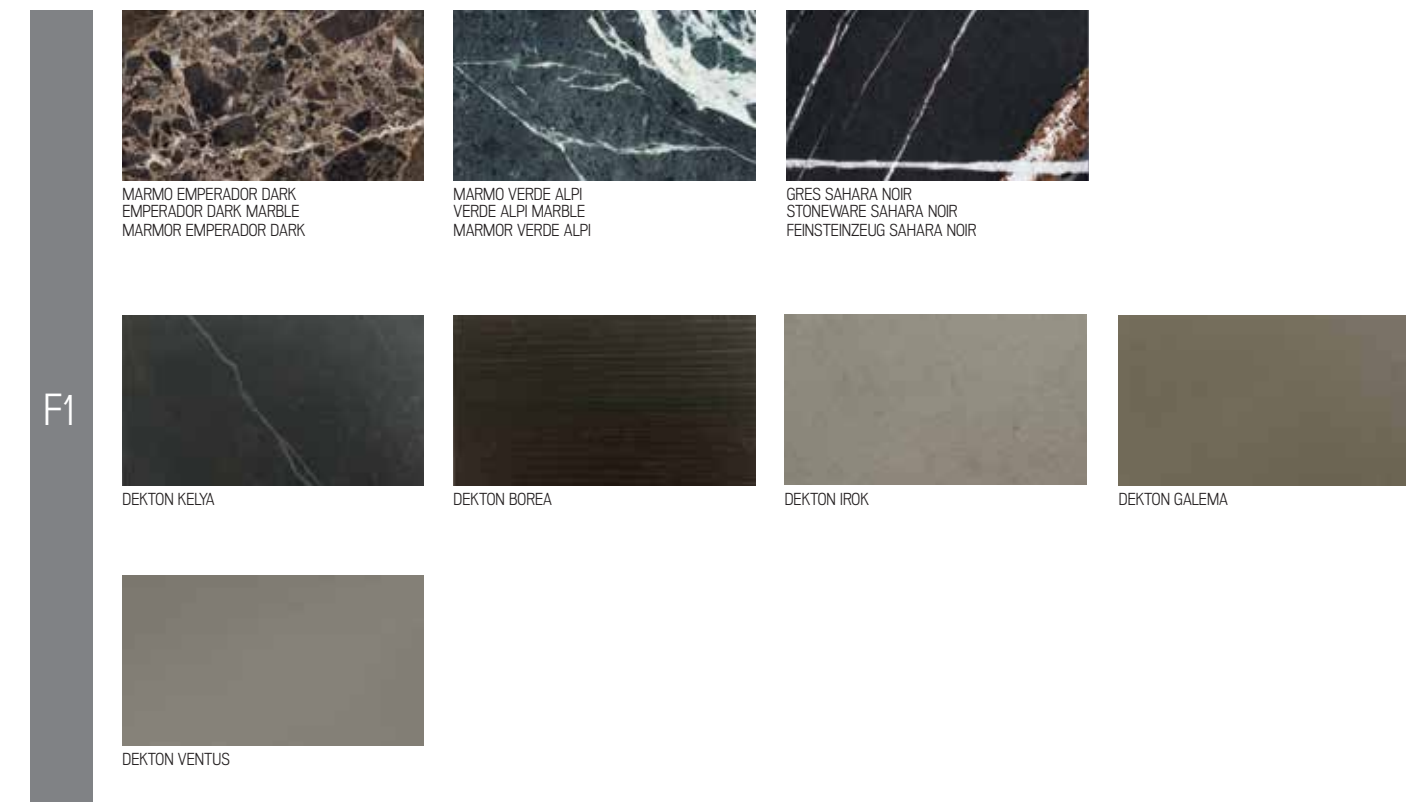

\***N.B.:** Riferimento Dekton classe 2. Altri colori disponibili a richiesta.

\***N.B.:** Reference Dekton class 2. Other colours available upon request.

\***N.B.:** Dekton Kat. 2. Andere Farben erhältlich auf Anfrage.



Tutti i campioni, così come le foto dei vari materiali e delle finiture disponibili, sono da considerarsi puramente indicativi. Eventuali difformità di colore e caratteristiche dei materiali usati per la produzione non potranno essere considerate motivo di contestazione, poiché legate alle loro caratteristiche naturali (es. venatura e nodi del legno, conformità del ferro o di pelli e tessuti etc.) o all'artigianalità della lavorazione (es. colore della finitura cemento, laccatura su ferro etc.).

Per ulteriori informazioni si prega di consultare l'allegato "A" alle nostre Condizioni Generali di Vendita, scaricabile dall'area riservata del nostro sito [www.riva1920.it](http://www.riva1920.it).

All samples, as well as pictures of the available materials and finishes, are to be considered as purely indicative. Possible differences in colour and features of the materials used for production cannot be considered as reason for claim, because linked to their natural characteristics (e.g. wood grain and knots, aspect of the iron or of leather and fabric etc.) or to the handcraft (e.g. concrete finish colour, lacquer on iron etc.).

For any further information you are kindly invited to read the Annex "A" to our General Sales Conditions, that can be downloaded from the reserved area of our website [www.riva1920.it](http://www.riva1920.it).

Alle Muster sowie Abbildungen dienen nur zur Veranschaulichung. Abweichungen bzgl. Farbe und Struktur der verwendeten Stoffe sind natur- und produktionsbedingt und können nicht als Mangel geltend gemacht werden. Für mehr Infos unsere allgemeinen Verkaufsbedingungen und Annex "A" unter LOGIN in unserer Webseite [www.riva1920.it](http://www.riva1920.it) einlesen.



## TARGHETTE DI IDENTIFICAZIONE PERSONALIZZATE

Riva 1920 offre la possibilità di realizzare targhette di identificazione in metallo che verranno apposte sui propri prodotti con laseratura del logo del cliente, previa richiesta specifica al momento dell'invio dell'ordine.

### CUSTOMIZED IDENTIFICATION PLATES

Riva 1920 offers the possibility to have customized metal plaques which will be placed on its products with a personalized customer's logo engraving, upon specific request when placing the order.

### PERSONALISIERTE KENNZEICHNUNGSSCHILDER

Riva 1920 bietet die Möglichkeit, individuelle Plaketten mit Kundenlogo zu bekommen, die auf die Produkte angebracht werden, falls es auf der Bestellung deutlich angegeben wird.

## SET MANUTENZIONE

Ogni prodotto è corredato da un set contenente uno specifico kit di trattamento in base al tipo di legno e alla finitura e le istruzioni per la manutenzione ordinaria.

### MAINTENANCE SET

Each product is always sent along with a maintenance kit specific for the wood and finish of that product, also containing the instructions for ordinary maintenance.

### PLEGESET

Ein Pflegeset und Gebrauchsanleitungen werden immer mit jedem Produkt mitgeliefert.



## NATURAL LIVING

### LA NOSTRA FILOSOFIA DEL "VIVERE NATURALE"

Ogni cliente che acquista un prodotto Riva 1920, riceve in omaggio un piccolo alberello, coltivato a partire dal seme in vivai appositamente creati, da piantare nel giardino di casa, in un bosco oppure in un parco. Per chi non sarà in grado di mettere a dimora la piantina, Riva 1920 ha pensato anche "all'adozione a distanza". Per partecipare al progetto Natural Living è sufficiente compilare il modulo scaricabile dal sito internet [www.riva1920.it](http://www.riva1920.it) e presentarlo al momento dell'acquisto presso il punto vendita autorizzato. Con questo semplice gesto il ciclo della natura non si interrompe, prendersi cura dell'ambiente deve diventare uno stile di vita ed un impegno concreto per la salvaguardia delle prossime generazioni.

### OUR PHILOSOPHY OF "LIVING NATURALLY"

*Upon request those who buy a product of Riva 1920's collection will receive a gift of a little seed-grown tree cultivated in specially created nurseries, to be planted in a garden, in a wood or in a park. For those who, while supporting the initiative, cannot plant this gift because they do not have a suitable space, Riva 1920 will arrange "long-distance adoption". In order to take part to our Natural Living Initiative, please download the form in our web site [www.riva1920.it](http://www.riva1920.it) and take it to the official Riva 1920 authorized retailer when buying a product. With this simple gesture the cycle of nature doesn't stop, taking care of the environment must become a lifestyle and a concrete commitment to preservation for future generations.*

### UNSERE PHILOSOPHIE VON „NATÜRLICH LEBEN“

*Jeder Kunde, der ein Produkt von Riva 1920 erwirbt, erhält als Geschenk einen kleinen Baum, der eigens zu diesem Zweck aus einem Samen in einer Baumschule gezüchtet wurde und im eigenen Garten, in einem Wald oder Park gepflanzt werden kann. Wer das Bäumchen nicht pflanzen kann, hat die Möglichkeit, mit Riva 1920 eine „Patenschaft“ zu vereinbaren. Um am Projekt Natural Living teilzunehmen, einfach das Formular von der Internetseite [www.riva1920.it](http://www.riva1920.it) herunterladen und dieses beim Kauf dem autorisierten Händler vorlegen. Durch diese einfache Geste wird der Naturkreislauf nicht unterbrochen. Die Pflege der Natur muss zu einem Lebensstil und einer konkreten Verpflichtung werden, um die nächsten Generationen zu schützen.*



L'immagine proposta è puramente indicativa - The image is purely for information - Das Bild ist nicht verbindlich

## DESIGN ECO

Abitare secondo natura - Più attenzione all'ambiente nei materiali e nei modi di produrre per non sprecare le potenzialità che ogni prodotto naturale ha in sé.

Nel petto dell'azienda batte un cuore fatto di legno. Riva 1920 ama la natura, ma anche i suoi clienti ed è per questo che offre un prodotto autentico fatto in vero legno naturale nel pieno rispetto dell'ambiente e delle persone che lo abitano. Rivestimenti, colle, vernici, mobili e molti altri elementi e oggetti di uso quotidiano presenti nelle nostre case, sono accomunati dal contenere formaldeide, un gas incolore dai numerosi derivati e dalle mille proprietà: un potente battericida e disinfettante ma anche un fissativo di uso comune, nonché un ottimo conservante. Peccato però che l'esposizione prolungata alla formaldeide, le cui molecole tendono con il tempo ad essere rilasciate nell'ambiente circostante, sia potenzialmente tossica facendone uno dei più diffusi inquinanti di interni; basti pensare che è stata inserita nell'elenco delle sostanze cancerogene per l'uomo. Proprio per questo motivo da oltre 30 anni Riva 1920 si impegna quotidianamente per garantire la naturalità dei suoi prodotti al fine di assicurare la massima qualità dell'aria indoor necessaria per il benessere fisico di tutta la famiglia.

*Living according to the nature - More attention to the environment through the use of materials and methods of production to avoid wasting the potential that every natural product has.*

*In the company's chest beats a wooden heart. Riva 1920 loves nature, and so do its customers; that's why it offers an authentic product in real natural wood, respecting the environment and the people who live in it. Upholstery, glues, paints, furniture and many other elements and everyday things in our homes contain formaldehyde, a colourless gas with various derivatives and with numerous features: a strong bactericide and disinfectant, but also a commonly used fixative and a good preservative.*

*Bad news is, a prolonged exposure to formaldehyde, whose molecules tend with time to be emitted into the surrounding environment, is potentially toxic, making it one of the most common interior pollutants; in fact it has been listed as one of the carcinogenic substances for the human being. That's why since more than 30 years Riva 1920 is daily committed to guarantee a natural product, in order to ensure good indoor air quality for the family well-being.*

*Naturgemäß leben - Der Umwelt bei Herstellungsweisen und Materialien mehr Aufmerksamkeit schenken, um das Potenzial von jedem natürlichen Produkt nicht zu verschwenden.*

*In der Brust des Unternehmens schlägt ein Herz aus Holz. Riva 1920 und auch seine Kunden lieben die Natur und daher wird ein echtes Produkt aus natürlichem Holz angeboten, das sowie die Natur als auch die Personen achtet. Verkleidungen, Klebstoffe, Lacke, Möbel und viele andere Elemente und Gegenstände des täglichen Gebrauchs unserer Häuser enthalten Formaldehyd, ein farbloses Gas zahlreicher Derivate und mit vielen Eigenschaften: ein wirkungsvolles keimtötendes und desinfizierendes Mittel, aber auch ein allgemein gebräuchliches Fixiermittel sowie ein ausgezeichnetes Konservierungsmittel. Es ist nur schade, dass eine langandauernde Formaldehyd-Exposition potentiell giftig ist, da seine Moleküle wieder in die Umgebung abgegeben werden, wodurch es zu einem der verbreitetsten verunreinigten Stoffe in Innenräumen zählt. Formaldehyd steht nämlich auf der Liste jener Substanzen, die für den Menschen krebserregend sind. Aus diesem Grund bemüht sich Riva 1920 seit über 30 Jahren täglich, die Natürlichkeit seiner Produkte zu garantieren, um die höchste Luftqualität in Innenräumen sicherzustellen, die für das Wohlbefinden der ganzen Familie wichtig ist.*



**DESIGN ECO** 

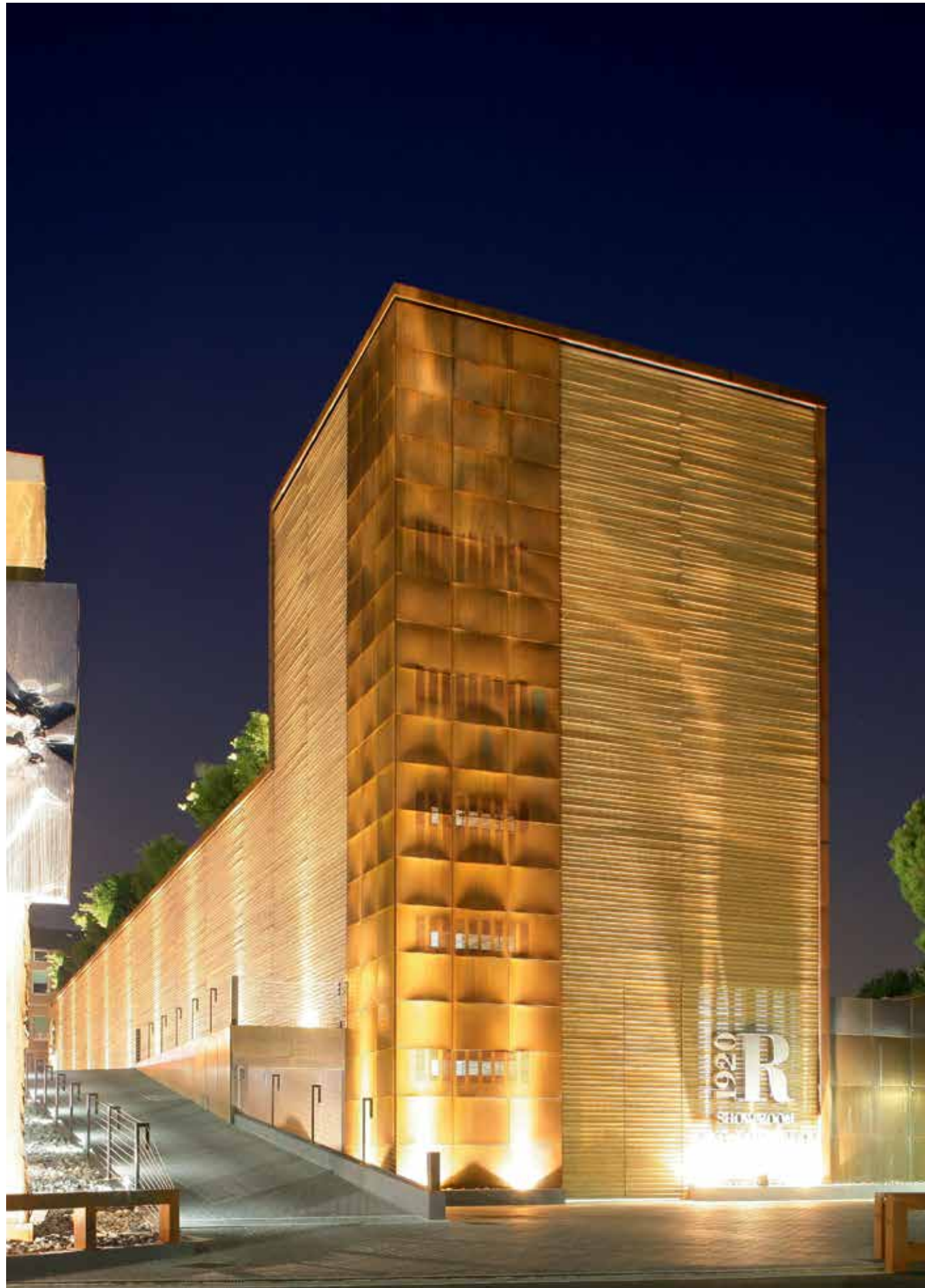

## RIVA CENTER

Il Riva Center è un edificio suggestivo totalmente ricoperto in legno di larice siberiano, inaugurato nel 2010. Il rivestimento è nato da un'idea progettuale dello studio Renzo Piano Building Workshop effettuato per l'università di Harvard.

## RIVA CENTER

*Riva Center is an amazing building completely covered with Siberian larch wood, built in 2010 based on from a project idea of the design studio Renzo Piano Building Workshop carried out for Harvard University.*

## RIVA CENTER

*Riva Center ist ein beeindruckendes Gebäude, das vollkommen mit sibirischem Lärchenholz verkleidet ist und 2010 eröffnet wurde. Die Verkleidung ist eine Projektidee vom Studio Renzo Piano Building Workshop und wurde für die Universität Harvard durchgeführt.*

## SHOWROOM

Al piano terra del Riva Center si trova uno Showroom di circa 1200 mq, che esalta l'essenza e l'unicità della collezione di arredi realizzati in vero legno massello. Lo spazio accoglie altresì una collezione di vecchie biciclette dei mestieri risalenti ai primi del 1900.

## SHOWROOM

*On the ground floor of Riva Center there is a Showroom of about 1200 square meters, which exalts the essence and uniqueness of the collection of solid wood furniture. The space also houses a collection of old bicycles of the crafts dating from the early 1900s.*

## SHOWROOM

*Im Erdgeschoss des Riva Centers befindet sich der Showroom, 1200 Quadratmeter, der die Eigenschaften und die Einmaligkeit der Produkte aus Massivholz betont. Hier ist auch eine Sammlung alter Fahrräder zu sehen, die Beginn des 20. Jahrhunderts als Fahrzeuge für unterschiedliche Berufe dienten.*

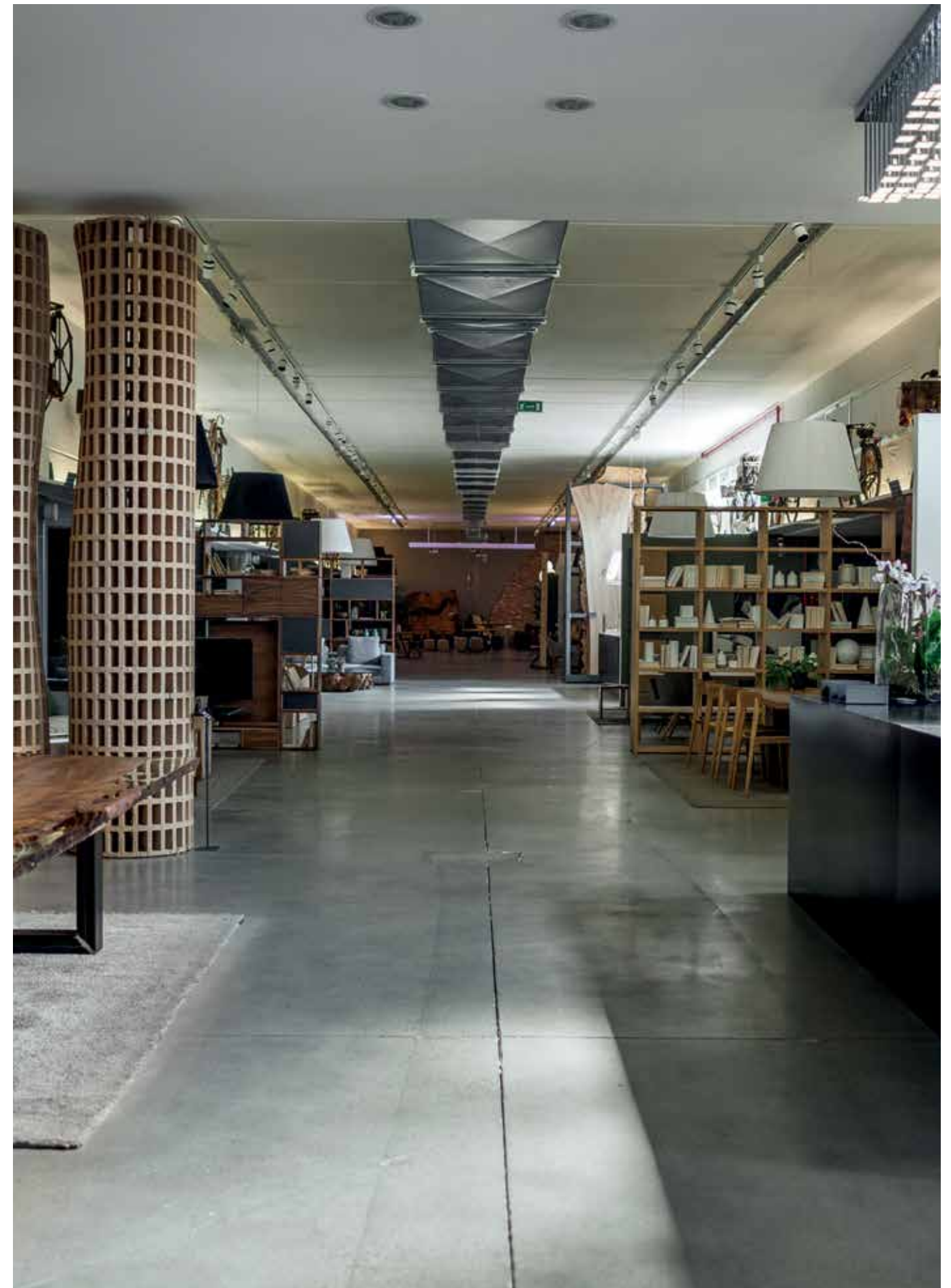



## MUSEO DEL LEGNO

Al primo piano dello stabile si trova il Museo del Legno, con un'esposizione di oltre 5.000 pezzi tra macchine ed utensili per la lavorazione del legno (datazione 1850/1930), collezione unica nel suo genere in Europa per la quantità di pezzi presenti. Obiettivo far riscoprire le origini e le tradizioni tipiche dell'ebanisteria, esponendo molti utensili provenienti da antiche botteghe artigiane italiane. Nell'ampio salone si trovano pialle, banchi da lavoro, torni, combinate, pultrici, seghe a nastro, bindelle: termini tecnici quasi dimenticati. Protagonista indiscusso dello spazio il tavolo "Antico" in legno millenario di Kauri datato 48.000 anni e lungo 12 metri, caratterizzato da una base in ferro disegnata dall'architetto Renzo Piano.

## MUSEUM OF WOOD

*On the first floor of the building there is the Museum of Wood, with an exhibition of over 5.000 pieces including woodworking machines and tools (dating back to 1850/1930), a unique collection of its kind in Europe for the quantity of pieces. The aim is to rediscover the typical origins and traditions of cabinet making, by exhibiting many tools coming from ancient Italian artisan shops. In the large hall there are planes, workbenches, lathes, combined machines, sanding machines, band saws: almost forgotten technical terms. The undisputed protagonist of the space is the "Antico" table made of millennial Kauri wood dated 48,000 years and 12 meters long, characterized by an iron base designed by the architect Renzo Piano.*

## HOLZMUSEUM

*Im ersten Stock des Gebäudes befindet sich das Holzmuseum mit über 5.000 Ausstellungsstücken, Maschinen und Werkzeugen zur Holzbearbeitung aus dem Zeitraum 1850/1930, eine einzigartig große Sammlung dieser Art in Europa. In der Ausstellung können der Ursprung und die typischen Traditionen der Kunstschlerei wiederentdeckt werden, dank der vielen Werkzeugen aus alten italienischen Schreinerwerkstätten. Im geräumigen Raum werden Hobel, Werk- und Drehbänke, Kombimaschinen, Poliermaschinen, Bandsägen gezeigt. Fachausdrücke, die fast in Vergessenheit geraten sind. Unbestrittene Hauptfigur dieses Raumes ist der Tisch "Antico" aus tausendjährigem Kauri-Holz, 48.000 Jahre alt und 12 Meter lang, der sich durch sein Gestell aus Eisenrohren auszeichnet, Design vom Architekten Renzo Piano.*

## PANGEA LAB

Al secondo piano si trova il Pangea Lab, spazio suggestivo realizzato in legno di abete e vetro che ospita il tavolo Pangea, simbolo di Expo 2015 a firma di Michele de Lucchi che si ispira all'unico continente che in origine si ritiene includesse tutte le terre emerse e che durante le successive ere geologiche si è diviso nei vari continenti. La superficie di 80 metri quadrati realizzata in Kauri, legno originario della Nuova Zelanda, è composta da 19 pezzi sagomati ed è sostenuta da 271 gambe realizzate in Briccola, pali di rovere recuperati della laguna di Venezia.

## PANGEA LAB

*On the second floor you find the Pangea Lab, an evocative space made of fir wood and glass that houses the Pangea table, a symbol of Expo 2015 designed by Michele de Lucchi, which is inspired to the supercontinent that consisted of the current continents joined together and that during the following geological eras started breaking up. The 80-square-meter surface made of Kauri, a wood coming from New Zealand, is made up of 19 shaped pieces and is supported by 271 legs made of Briccola, reused oak poles from the Venetian lagoon.*

## PANGEA LAB

*Im zweitem Stock ist Pangea Lab, ein eindrucksvoller Ort aus Fichtenholz und Glas in dem sich der Tisch Pangea befindet, Symbol der Expo 2015, der von Michele de Lucchi entworfen wurde und sich am einzigen Kontinent inspiriert, der zu Beginn das ganze Festland enthielt, welches sich in den nachfolgenden geologischen Epochen in die verschiedenen Kontinente getrennt hat. Er hat eine Oberfläche von 80 Quadratmetern und wurde aus Kauri hergestellt, dem aus Neuseeland stammenden Holz; er besteht aus 19 Formteilen, die durch 271 Tischbeine aus Briccola getragen werden, Eichenholzpfähle aus der Lagune von Venedig.*

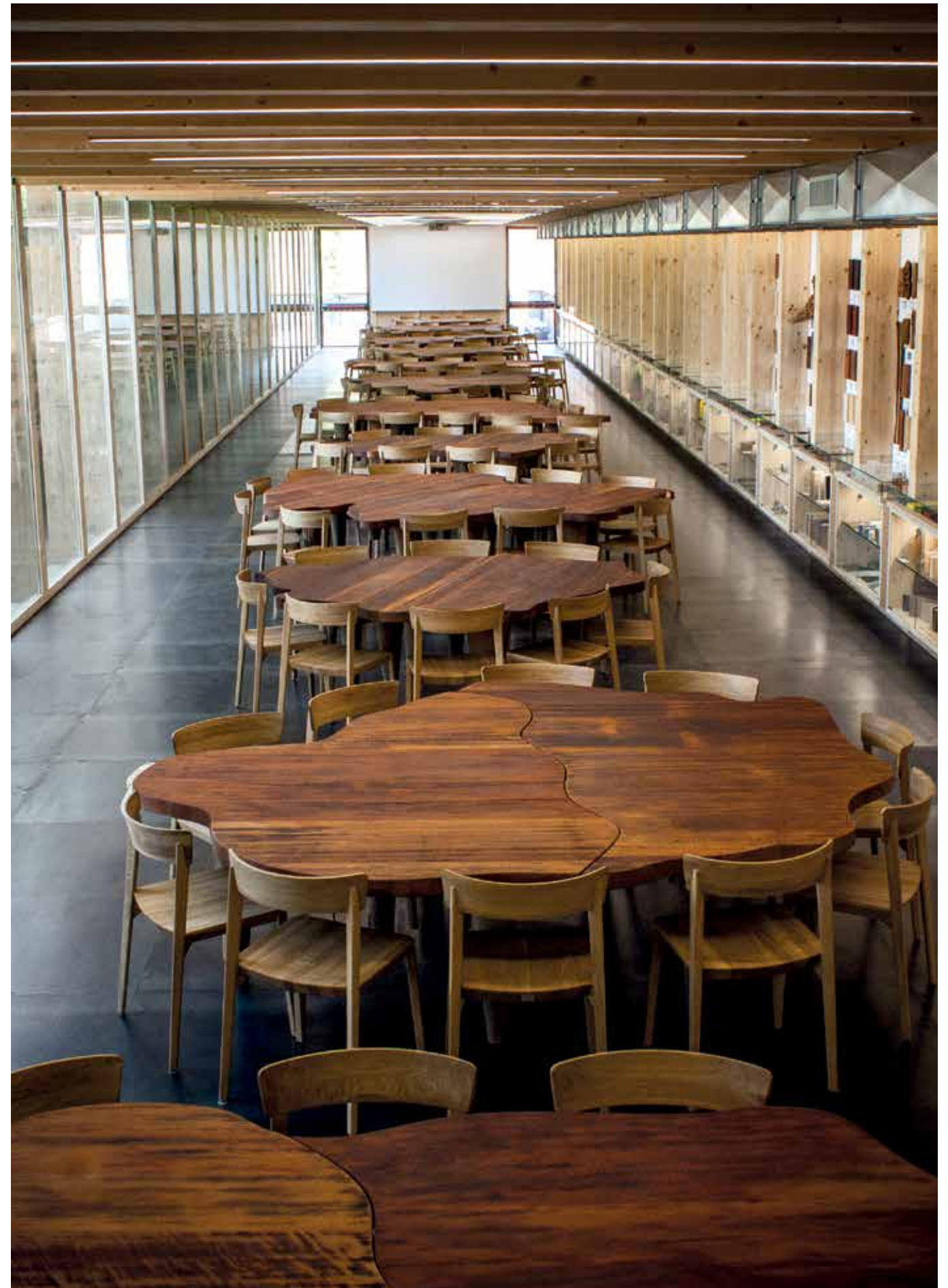

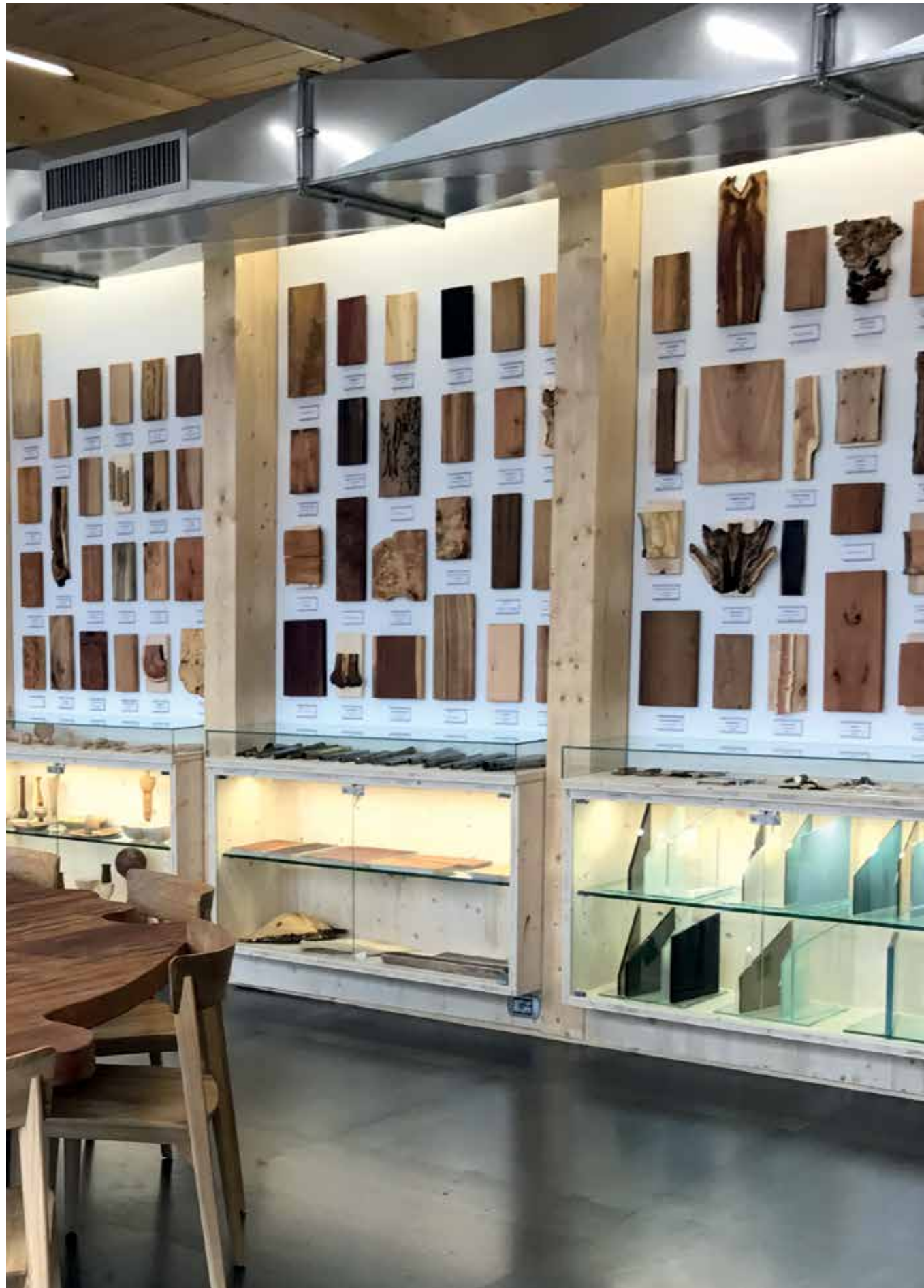

## XILOTECA

Lungo le pareti dello spazio Pangea Lab si trova una xiloteca, una vera e propria seconda installazione museale all'interno del Riva Center, una raccolta minuziosa di circa 900 legni provenienti da tutto il mondo. Nelle sottostanti teche di vetro si trova selezione di materiali naturali, frutto della collaborazione con aziende del territorio. Si tratta di uno spazio didattico e formativo per far conoscere da vicino le lavorazioni ed i materiali attraverso l'organizzazione di workshop dedicati a studenti ed addetti al settore.

## XYLOTHEQUE

*Along the walls of the Pangea Lab space there is a xilothèque, a real second museum inside the Riva Center, a meticulous collection of about 900 woods coming from all over the world. In the underlying glass cases there is a selection of natural materials, the result of collaboration with local companies. It is an educational and training space to make the processes and materials known through the organization of workshops dedicated to students and other companies working in the region.*

## XYLOTHEK

*Entlang der Wände des Pangea Lab befindet sich eine Xylotek, eine echte zweite Museumsinstallation im Riva Center und eine sorgfältige Sammlung von etwa 900 Hölzern aus der ganzen Welt. In den darunter liegenden Glasvitrinen gibt es eine Auswahl natürlicher Materialien, die dank der Zusammenarbeit mit anderen lokalen Unternehmen ausgestellt werden können. Es handelt sich um einen Bildungs- und Trainingsraum, dessen Ziel ist die Materialien und die Prozesse durch Workshops für Studenten und Fachleute bekanntzumachen.*

## UNITÀ PRODUTTIVE

L'unità produttiva 1 è dedicata alla produzione di credenze, armadi, librerie, letti e complementi d'arredo; macchinari tecnologicamente avanzati si alternano a banchi da falegnami e i processi industriali alle lavorazioni artigianali. Taglio, bordatura, incollaggio, impiallacciatura, pressatura, assemblaggio, oliatura, montaggio e controllo qualità: passaggi fondamentali per arrivare al mobile finito, sinonimo di qualità.

L'unità produttiva 2 dedicata alla produzione di tavoli in legno massello, in particolare di Kauri o di Briccola. Rastrelliere in ferro contengono i top pronti per essere lavorati; le tavole a liste incollate vengono fatte "riposare" per prevenire i naturali movimenti, quelle in Kauri vengono fotografate ed inserite in un apposito catalogo per la scelta dell'acquirente. Ciascuno è un pezzo unico.

L'unità produttiva 3, dedicata alla lavorazione del legno di cedro per la realizzazione di sgabelli, panche e tavolini. I tronchi nel piazzale antistante lo stabilimento sprigionano nell'aria un profumo caratteristico ed inebriante. Una ruspa li preleva e li porta all'interno della fabbrica per il taglio longitudinale a cui segue la fase di scortecciamento ed infine di definizione della forma del prodotto tramite una dima. Il blocco viene poi inserito nel centro di lavoro e al termine del processo di lavorazione si passa alla levigatura che rende la superficie liscia.

### PRODUCTION UNITS

*Production unit 1 is dedicated to the production of sideboards, wardrobes, bookcases, beds and accessories; cutting-edge technology together with carpenter's benches, industrial processes and craftsmanship. Cutting, edging, gluing, veneering, pressing, oiling, assembly and final quality control: these are the steps to get to the finished product, symbol of quality.*

*Production unit 2 is instead dedicated to the production of solid wood tables and in particular those in Kauri or Briccola wood. Iron racks contain the tops ready to be worked; tops in glued lists are let to "rest" to prevent natural movements; Kauri slabs are photographed and showed to the customer in a dedicated catalogue. Each piece is unique.*

*Production unit 3 is dedicated to the production of cedar wood products: stools, benches and small tables. The trunks stored in the yard in front of the production unit release a characteristic scent into the air. A bulldozer picks them up and takes them inside the factory for the longitudinal cut and the debarking phase, then the shape of the stool is traced through a template. The block is then put into the CNC machine and it is sanded to make the surface smooth.*

### PRODUKTIONSSTÄTTE

*Die Produktionsstätte 1 stellt Kommoden, Schränke, Regale, Betten und Einrichtungsobjekte her. Technologisch fortschrittliche Maschinen neben traditionellen Tischlerbänken und industrielle Prozesse neben Handwerk. Schneiden, Kleben, Furnieren, Pressen, Montage, Ölen und schließlich Qualitätskontrolle: diese sind die Schritte bis zum fertigen Möbelstück, das zum Synonym für Qualität wird.*

*Die Produktionsstätte 2 stellt Massivholztische her, unter denen auch Tische aus Kauri und Briccole. Hier stehen immer Tischplatten zum Bearbeiten bereit. Tischplatten aus verleimten Leisten werden horizontal gelagert um eventuelle Holzbewegungen zu vermeiden. Kauriplatten werden fotografiert und dank einem speziellen Katalog den potenziellen Käufern angeboten. Jede Platte ist ein Unikat.*

*Schließlich verarbeitet die Produktionsstätte 3 Zedernholz zur Herstellung von Hockern, Bänken und Couchtischen. Die Stämme werden auf dem Vorplatz der Produktionsstätte gelagert und erfüllen die gesamte Umgebung mit einer charakteristischen Duftnote. Ein Bulldozer nimmt sie auf und bringt sie für den Längsschnitt und die Entrindung in die Fabrik, danach wird die Form des Hockers durch eine Schablone auf der Oberfläche gezeichnet. Der Block wird dann in den CNC-Maschinen bearbeitet und per Hand geschliffen, wodurch die Oberfläche glatt wird.*



UNITÀ PRODUTTIVA 1 · PRODUCTION UNIT 1 · PRODUKTIONSSTÄTTE 1



UNITÀ PRODUTTIVA 2 · PRODUCTION UNIT 2 · PRODUKTIONSSTÄTTE 2



UNITÀ PRODUTTIVA 3 · PRODUCTION UNIT 3 · PRODUKTIONSSTÄTTE 3



ALDO CIBIC  
ALDO SPINELLI  
ALESSANDRO GUIDOLIN  
ALESSANDRO MENDINI  
AMEBE DESIGN STUDIO  
ANDREA BRANZI  
ANDREA CASTRIGNANO  
BALDESSARI & BALDESSARI  
BARTOLI DESIGN  
BENNO VINATZER  
BOYAN GRIGOROV  
BRODIE NEILL  
C.R.&S. RIVA 1920  
CARLO COLOMBO  
CENGIZ CIVAN  
CLAUDIO BELLINI  
DANIEL GERMANI  
DAVID CHIPPERFIELD  
DAVID DOLCINI  
DAVID KNOTT  
DAVIDE RIVA  
DODO ARSLAN  
ELIO FIORUCCI  
ENZO MARI  
ERASMO FIGINI  
FABIO NOVEMBRE  
FABRIZIO ZAPPA  
FRANCIS KÉRÉ  
FRANCO & MATTEO ORIGONI  
GALIMBERTI & BIZZARRO  
GIOVANNA AZZARELLO  
GIULIANO & GABRIELE CAPPELLETTI  
GIULIANO CAPPELLETTI  
GUALTIERO MARCHESI  
HELIDON XHIXHA  
HIKARU MORI  
HSIAO-CHING WANG  
ISABELLE RIGAL  
JAKE PHIPPS  
JAMIE DURIE  
KARIM RASHID  
KARSTEN SCHMIDT-HOENS DORF  
KAZUYO KOMODA

DESIGNERS FOR RIVA 1920

LUCA MARTORANO & MATTIA ALBICINI  
LUCA SCACCHETTI  
LUISA CASTIGLIONI  
MARC SADLER  
MARCO BAXADONNE  
MARCO BOGA  
MARCO PIVA  
MARIA SAADEH  
MARIO BELLINI  
MARIO BOTTA  
MARIO CUCINELLA  
MATTEO THUN  
MAURIZIO RIVA  
MICHELE DE LUCCHI  
MICHELE TAVANO  
MOTOMI KAWAKAMI  
NERI & HU  
NESPOLI E NOVARA  
PAOLA NAVONE  
PAOLO PININFARINA  
PAOLO PIVA  
PAOLO SALVADÈ  
PASSON & SAVORGNANI  
PATRICIA URQUIOLA  
PATRIZIA BOZUFFI  
PETER KERN  
PHILIPPE STARCK  
PIERLUIGI CERRI  
PIERO LISSONI  
PININFARINA  
PINUCCIO SCIOLA  
RENZO & MATTEO PIANO  
RICCARDO ARBIZZONI  
SAKURA ADACHI  
SETSU & SHINOBU ITO  
SOLONI, GRANDE, REVESZ  
STEFANO BOERI  
STEFANO LAROTONDA  
STEVE LEUNG  
STUDIO ZERO  
TERRY DWAN  
THOMAS HERZOG  
VEGNI DESIGN  
VENEZIANO+TEAM

COPYRIGHT © RIVA 1920  
ALL RIGHTS RESERVED.

ANY REPRODUCTION,  
REPRESENTATION  
OR MODIFICATION,  
IN FULL OR PARTLY, OF THIS  
CATALOGUE  
IS EXPRESSLY PROHIBITED.

FOR FURTHER INFORMATION  
PLEASE VISIT [www.riva1920.it](http://www.riva1920.it)



STYLING  
COMMUNICATION  
GRAPHIC DESIGN

**RIVA 1920**  
**MARIKA RIVA**  
**CINZIA PORRO**

PRINTED IN 2020  
**LA GRAFICA · CANTÚ**

PHOTO  
**MARCO BELLO**  
**STUDIO ELEVEN**

Descriptions, colours and pictures of products included in this catalogue have an indicative value only and are not binding for products use. Riva 1920 reserves the right to modify their products without prior notification.

Riva 1920 è ora disponibile su scala globale in oltre 90 Paesi attraverso una rete di oltre 450 punti vendita autorizzati.  
*Riva 1920 is now globally available in more than 90 Countries with an authorized Dealer network of 450 Stores.*  
*Riva 1920 ist jetzt weltweit in mehr als 90 Länder vertriebt und zählt ungefähr 450 offizielle Händler.*



**RIVA 1920**

**Industria Mobili SPA**

Via Milano, 137  
22063 Cantù  
Como · Italy  
T. +39 031 73 30 94  
F. +39 031 73 34 13  
info@riva1920.it

**Production unit - 1**

Via Milano, 137  
22063 Cantù  
Como · Italy

**Production unit - 2**

Via Genova, 13  
22063 Cantù  
Como · Italy

**Production unit - 3**

Via Como, 74  
22066 Mariano C.se  
Como · Italy

**Riva Center**

Via Milano, 110  
22063 Cantù  
Como · Italy

**Riva Farm**

Cucciago  
Como · Italy