

PATRIZIAGARGANTI

Firenze

From first to last structural and aesthetics elements  
many extraordinary attentions, and one only imperative:

# Handmade in Florence

ITALIAN • CUSTOM • LUXURY

# Contents

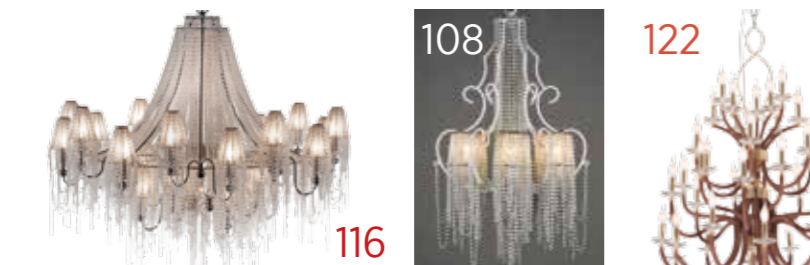
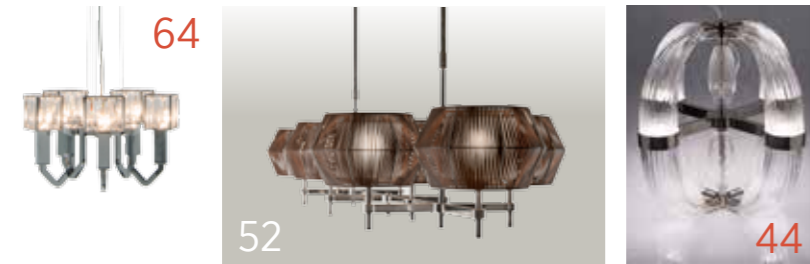
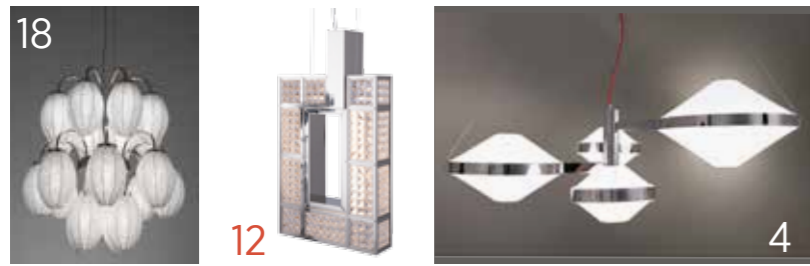

4 **Velasca**  
A different tale...

12 **Coccofilo**  
Birth of a precious love

18 **Bloom**  
Threethousandsixhundredtwentyeight pearls,  
one strand

26 **Frida**  
Attitude and grace

34 **Chaos**  
Composition of hexagons

44 **Coup De Foudre**  
Love at first sight

52 **Novecento**  
Dancing chandeliers

64 **Angie**  
A merry-go-round  
of geometries

70 **Gisele**  
Like a luminous  
choreography

80 **Tur**  
The precious modularity

88 **Holly**  
Light gems

94 **Frozen**  
Arctic Light

98 **Dew**  
Drops of Memory

108 **Burlesque**  
Pearl drapery

116 **Ontherocks**  
Crystal rain

122 **Moulin Rouge**  
Sparkle of a newfound time

1180 Sensual embrace

132 **Ginger&Fred**  
Dance for two

136 **Nana**  
Magical berries

140 **Morgana**  
A fairy and her knights

144 **Ophelia**  
Strawberry fields

154 **Margherita**  
A petal leads to another

162 **Eva**  
A chain is forever

166 **Sinuosa**  
Light tentacles

170 **Ricercata**  
Impeccable passions

176 **Preziosa**  
Easy luxury

180 **Vanitosa**  
Charleston vibes

184 **Eccentrica**  
Never-ending cascade

188 **Estrosa**  
Arabesque

192 **Raffinata**  
The name is a destiny

196 **Stravagante**  
In the mood for love

200 **Home**

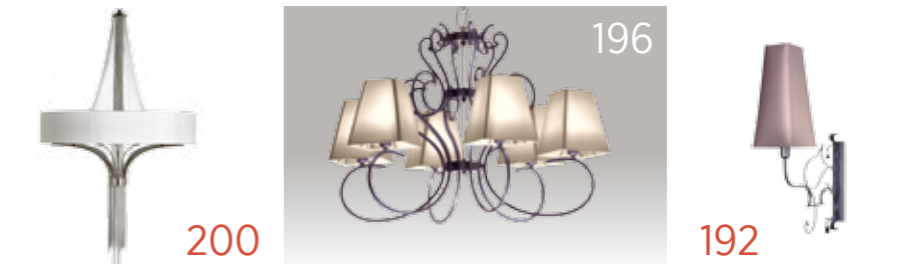
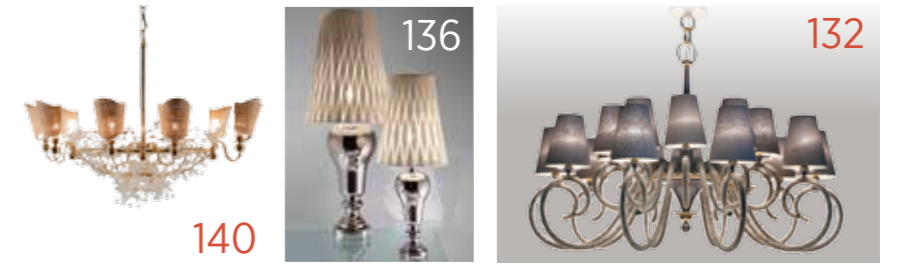



designer ROBERTO LAZZERONI

## Velasca

year: 2019

A collection that, drawing its inspiration from 50's and 60's italian rationalism, strikes an absolutely contemporary look

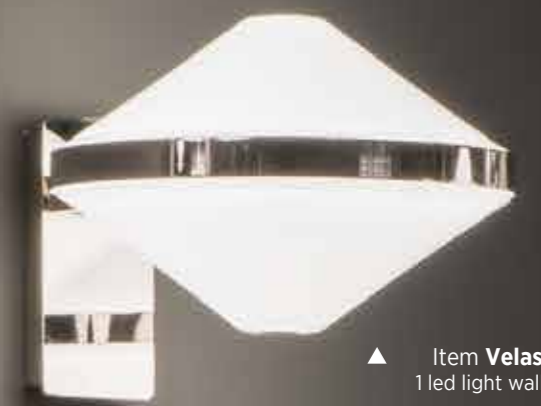

▲ Item **Velasca 14**  
1 led light wall lamp

◀ Item **Velasca 02**  
4 led lights chandelier  
Finish: Polished nickel  
Accessories: Incamiciato  
white blown glass



◀ Item **Velasca 08**  
2 led lights chandelier



▲ Item **Velasca 15**  
1 led light wall lamp



▲ Item **Velasca 11, Velasca 12, Velasca 13**  
1 led light table lamp  
Finish: Polished nickel  
Accessories: Incamiciato white blown glass



## A different **tale...**

A lamp family characterized by a vintage touch and a project meant to explore unknown grounds.

A collection that, drawing its inspiration from 50's and 60's Italian rationalism, strikes an absolutely contemporary look. Velasca lays the foundations for a new chapter; a chapter that joins stories of artisan expertise to design history.



A collection that, drawing its inspiration  
from **50's and 60's**  
**italian rationalism**, strikes an absolutely  
**contemporary** look.

▲ Item **Velasca 06**  
3 led lights chandelier



finishes:



Polished nickel

Incamiato white blown glass



▲ Item **Velasca 01**  
4 led lights chandelier

# collection

<p>Item <b>Velasca 01</b> L.103 x D.74 cm H.85 cm min - 200 max</p>	<p>Item <b>Velasca 02</b> Ø 112 cm H.70 cm min - 200 max</p>	<p>Item <b>Velasca 03</b> Ø 98 cm H.65 cm min - 200 max</p>	<p>Item <b>Velasca 04</b> Ø 76 cm H.60 cm min - 200 max</p>	<p>Item <b>Velasca 05</b> Ø 112 cm H.70 cm min - 200 max</p>	<p>Item <b>Velasca 06</b> Ø 98 cm H.65 cm min - 200 max</p>	<p>Item <b>Velasca 07</b> Ø 76 cm H.60 cm min - 200 max</p>	<p>Item <b>Velasca 08</b> L.112 x D.40 cm H.70 cm min - 200 max</p>	<p>Item <b>Velasca 09</b> L.98 x D.33 cm H.65 cm min - 200 max</p>	<p>Item <b>Velasca 10</b> L.76 x D.22 cm H.60 cm min - 200 max</p>	<p>Item <b>Velasca 11</b> Ø 44 cm H.40 cm</p>	<p>Item <b>Velasca 12</b> Ø 36 cm H.33 cm</p>	<p>Item <b>Velasca 13</b> Ø 25 cm H.25 cm</p>	<p>Item <b>Velasca 14</b> L.41 x D.52 cm H.33 cm</p>	<p>Item <b>Velasca 15</b> L.33 x D.42 cm H.30 cm</p>	<p>Item <b>Velasca 16</b> L.22 x D.32 cm H.24 cm</p>
---	--	---	---	--	---	---	---	--	--	---	---	---	--	--	--



designer PATRIZIA GARGANTI

## Coccofilo

year: 2019

Newborn members of our family!

◀ Item **Coccofilo 02**  
Led lights chandelier  
Finish: Polished nickel  
Accessories: Clear crystals





Item **Coccofilo 01** ▶  
Led lights chandelier  
Finish: Polished nickel  
Accessories: Clear  
crystals

## *Birth of a precious love*

Newborn members of our family!  
Coccofilo is the latest model to join  
Patrizia Garganti's collections and with  
its precious and modular structure it  
sure has a bright future.





## collection

Item **Coccofilo 01**  
L.36 x D.12 cm  
H.75 cm min

Item **Coccofilo 02**  
L.76 x D.68 cm  
H.95 cm min

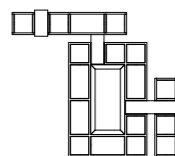
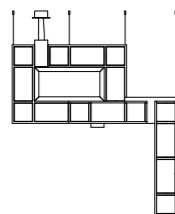
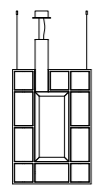

## metal finishes



polished nickel

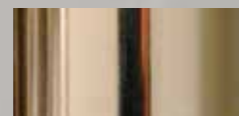

gold plated

## accessories



clear crystals

Item **Coccofilo 01** ▲  
Led lights chandelier  
Finish: Polished nickel  
Accessories: Clear crystals

designer PATRIZIA GARGANTI

## Bloom

year: 2019

Candid lampshades that remind of precious buds whose design combines the delicacy and the strength of a full bloom together.



◀ Item **Bloom 07**  
1 light wall lamp  
Finish: Gold plated & chrome details  
Lampshades: Clear crystal pearls

▲ Item **Bloom 06**  
20 lights chandelier  
Finish: Chrome  
Lampshades: Clear crystal pearls



*Threethousandsixhundredtwentyeight*  
**pearls, one strand.**

Candid lampshades that remind of precious buds whose design combines the delicacy and the strength of a full bloom together, stopping time a moment before it took place. A way to preserve its beauty, which is no longer ephemeral: the premise of a real and genuine private "hanami".

▲  
Item **Bloom 01**  
24 lights chandelier  
Finish: Gold plated & chrome details  
Lampshades: Clear crystal pearls



◀ Item Bloom 01  
24 lights chandelier  
Finish: Chrome  
Lampshades: Incamiciato white  
blown glass



*A way  
to preserve  
its **beauty**,  
which is no longer  
ephemeral:  
the premise of a **real**  
and **genuine**  
private  
“hanami”.*

Item **Bloom 01**  
Ø 105 cm  
H. 75 cm min.

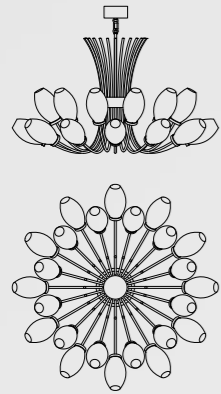

Item **Bloom 02**  
Ø 96 cm  
H. 70 cm min.

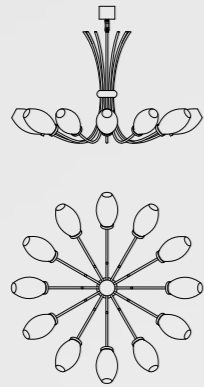

Item **Bloom 03**  
Ø 96 cm  
H. 70 cm min.

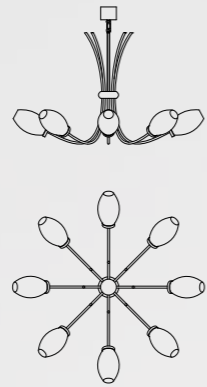

Item **Bloom 04**  
Ø 68 cm  
H. 70 cm min.



Item **Bloom 05**  
Ø 68 cm  
H. 70 cm min.



Item **Bloom 06**  
Ø 62 cm  
H. 75 cm min.



Item **Bloom 07**  
L.13 cm x D.21 cm  
H. 32 cm

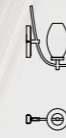

## metal finishes



chrome

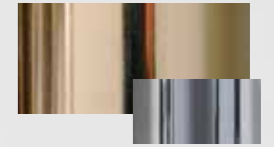

gold plated & chrome details

## lampshades



clear crystal pearls



incamiciato white blown glass

designer PATRIZIA GARGANTI

# Frida

year: 2018

A chandelier with a sober and discreet elegance.



▲ Item **Frida 02**  
9 lights chandelier  
Finish: Satin brass & polished brass details  
Lampshades: Incamiciato green blown glass

◀ Item **Frida 01**  
10 lights chandelier



▲ Item **Frida 01**  
 10 lights chandelier  
 Finish: Satin nickel & polished nickel details  
 Lampshades: Incamiciato pink blown glass

▼ Item **Frida 03** - 1 light wall lamp  
 Finish: Satin brass & polished brass details  
 Lampshade: Incamiciato green blown glass

▼ Item **Frida 03**  
 1 light wall lamp

▼ Item **Frida 03** - 1 light wall lamp  
 Finish: Satin nickel & polished nickel details  
 Lampshade: Incamiciato pink blown glass



▲ Item **Frida 02**  
 9 lights chandelier  
 Finish: Satin brass & polished brass details  
 Lampshades: Incamiciato white blown glass



▼ Item **Frida 03**  
1 light wall lamp



▼ Item **Frida 02** - 9 lights chandelier  
Finish: Gunmetal & polished nickel details - Lampshades: Clear blown glass



Item **Frida 03** ▼  
1 light wall lamp



## Attitude and *grace*

A chandelier with a sober and discreet elegance. Devoid of any concessions to decorations, hence capable of resonating both in classic and modern contexts. It combines strength and grace, with coexisting smooth and angular lines, just like Frida Kahlo, to whom it's dedicated. Frida is handcrafted with rigorously blown glass, a feature which grants it with imperfection and beauty.

▲ Item **Frida 01**  
10 lights chandelier  
Finish: Satin nickel & polished nickel details  
Lampshades: Clear blown glass



# collection

Item **Frida 01**  
 Ø 90 cm  
 H.90 cm min

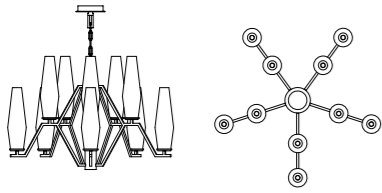

Item **Frida 02**  
 Ø 90 cm  
 H.100 cm min

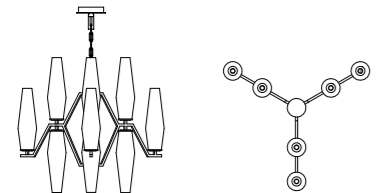

Item **Frida 03**  
 L.10 x D.22 cm  
 H.38 cm



Item **Frida 04**  
 L.10 x D.35 cm  
 H.54 cm



Item **Frida 05**  
 L.10 x D.35 cm  
 H.73 cm



clear

white

pink

green

## metal finishes



satin brass & polished brass details



satin nickel & polished nickel details



gunmetal & polished nickel details

incamiciato  
 blown glass  
 colour

designer PATRIZIA GARGANTI

## Chaos

year: 2018

The name encompasses its most intimate essence: from a starting module it is possible to replicate a myriad of infinite forms, hence Chaos.



▲ Item **Chaos 08**  
40 led lights chandelier  
Finish: Gold plated  
Lampshades: Clear cutted  
crystals



◀ Item **Chaos 06**  
32 led lights chandelier  
Finish: Polished nickel  
Lampshades: Hexagonal incamiciato  
white blown glass

▼ Item **Chaos 05**  
16 led lights chandelier  
Finish: Polished nickel  
Lampshades: Hexagonal incamiciato  
white blown glass



▲ Item **Chaos 10**  
2 led lights wall lamp  
Finish: Polished nickel  
Lampshades:  
Hexagonal clear blown  
glass



▲ Item **Chaos 11**  
2 led lights wall lamp  
Finish: Copper  
Lampshades:  
Hexagonal  
incamiciato white  
blown glass



▲ Item **Chaos 10**  
2 led lights wall lamp  
Finish: Gold plated  
Lampshades: Clear  
cutted crystals



▼ Item **Chaos 08**  
40 led lights chandelier  
Finish: Gold plated  
Lampshades: Hexagonal  
clear blown glass

Its *squared* lines  
recount a *functional*,  
aesthetic and  
geometric *storytelling*.



◀ Item **Chaos 07**  
32 led lights chandelier  
Finish: Gold plated  
Lampshades: Hexagonal  
incamiciato white blown  
glass

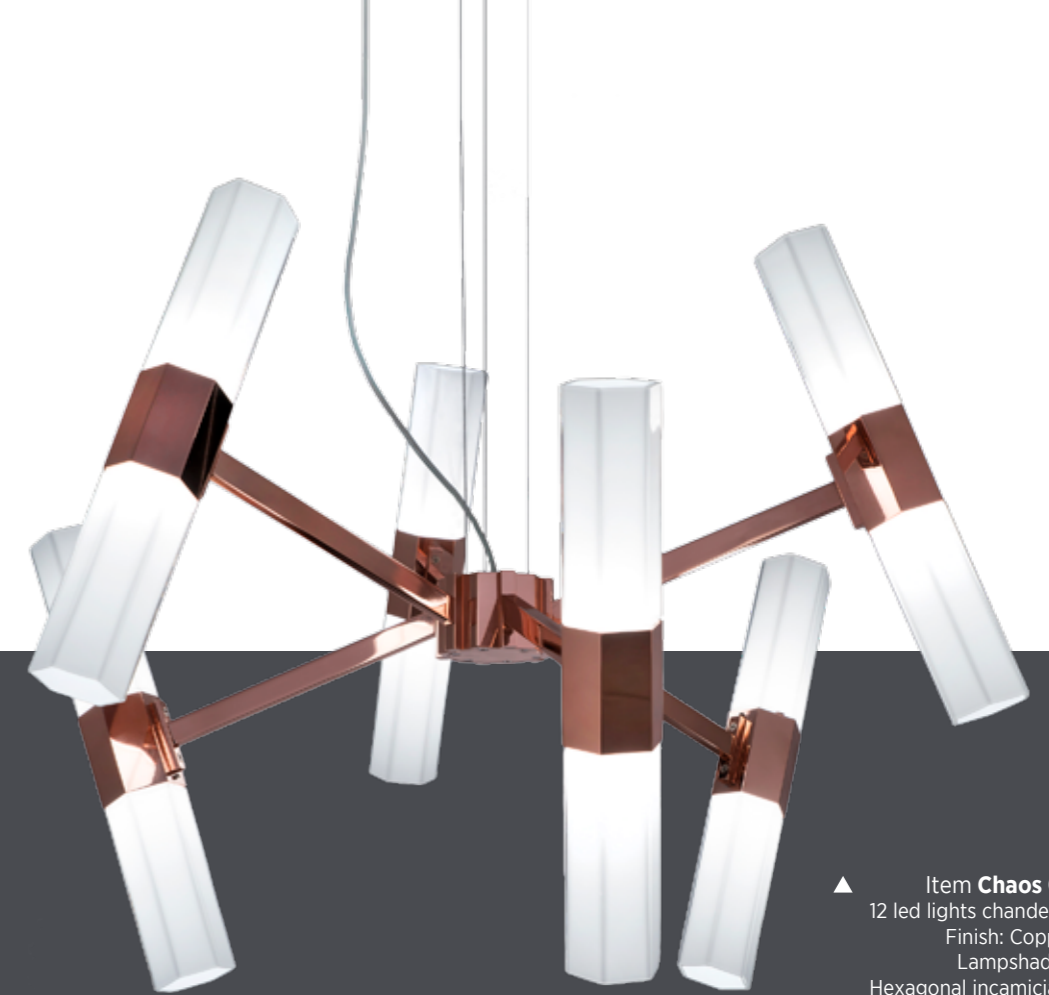

▲ Item **Chaos 04**  
12 led lights chandelier  
Finish: Copper  
Lampshades:  
Hexagonal incamiciato  
white blown glass  
▼

## Composition of *hexagons*

A calm chaos, elegant and composed. A stylistic system with structured tones where the real star is the hexagonal module. Its squared lines recount a functional, aesthetic and geometric storytelling. The name encompasses its most intimate essence: from a starting module it is possible to replicate a myriad of infinite forms, hence Chaos.

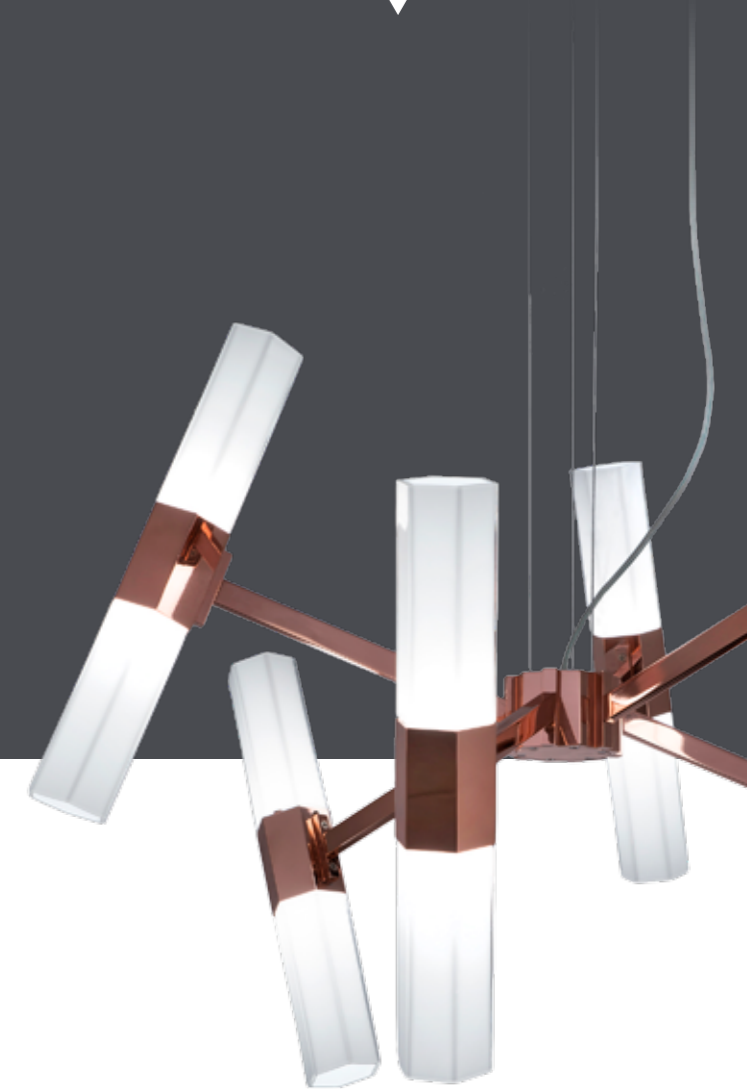



◀ Item **Chaos 03**  
(composition of 2 pieces)  
12+12 led lights chandelier  
Finish: Polished nickel  
Lampshades: Clear cutted  
crystals

▼ Item **Chaos 03**  
12 led lights chandelier  
Finish: Polished nickel  
Lampshades: Hexagonal clear  
blown glass



...from a starting module  
it is possible to **replicate**  
a myriad of infinite forms,  
hence **Chaos**.

# collection

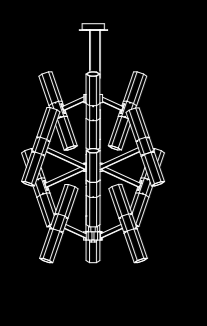
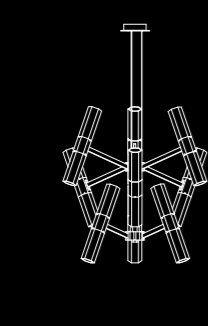
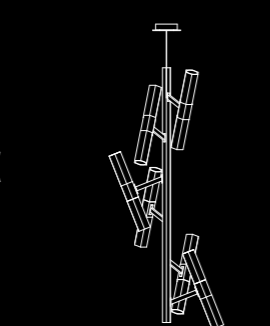
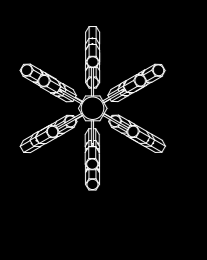
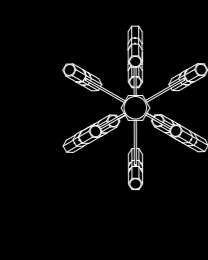
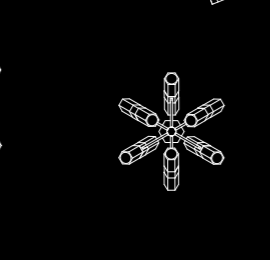
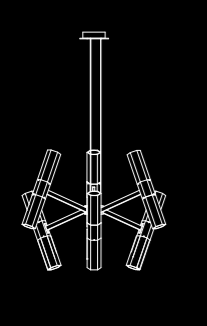
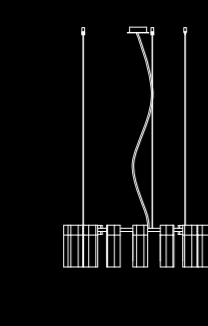
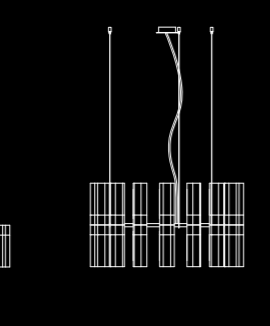
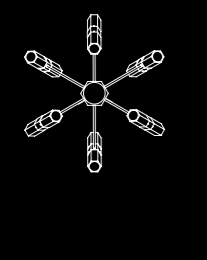
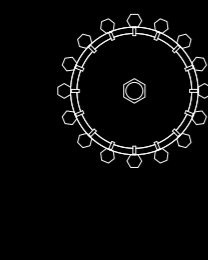
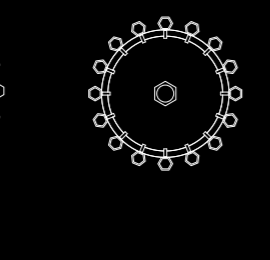
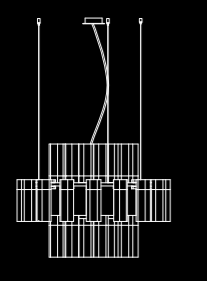
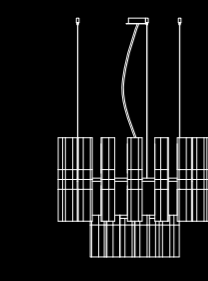
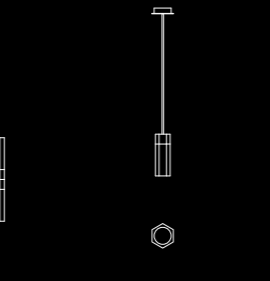
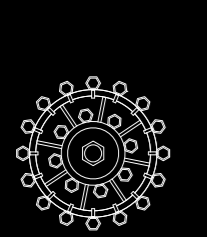
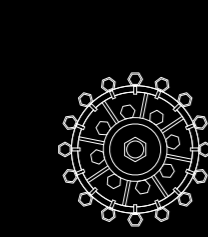
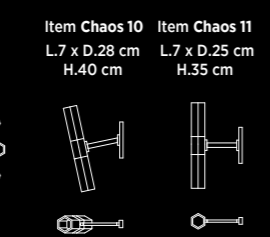
<p>Item Chaos 01 Ø 80 cm H.110 cm min</p> 	<p>Item Chaos 02 Ø 80 cm H.90 cm min</p> 	<p>Item Chaos 03 Ø 55 cm H.165 cm min</p> 
		
<p>Item Chaos 04 Ø 80 cm H.60 cm min</p> 	<p>Item Chaos 05 Ø 72 cm H.40 cm min</p> 	<p>Item Chaos 06 Ø 72 cm H.70 cm min</p> 
		
<p>Item Chaos 07 Ø 72 cm H.70 cm min</p> 	<p>Item Chaos 08 Ø 72 cm H.70 cm min</p> 	<p>Item Chaos 09 Ø 7 cm H.30 cm min</p> 
		<p>Item Chaos 10 L.7 x D.28 cm H.40 cm</p> <p>Item Chaos 11 L.7 x D.25 cm H.35 cm</p> 



◀ **Item Chaos 03**  
12 led lights chandelier  
Finish: Polished nickel  
Lampshades: Hexagonal  
incamiciato white blown glass

## lampshades



hexagonal clear blown glass



hexagonal incamiciato white  
blown glass



clear cutted crystals

## metal finishes



polished nickel



gunmetal



gold plated



copper

designer ROBERTO LAZZERONI

## CDF - Coup De Foudre

year: 2017

A precious, important, customizable collection,  
made of voluptuous cornucopias illuminated  
by a dimmable led light.



▲ Item **CDF01** (composition of 4 pieces)  
Led chandelier  
Finish: Satin gold  
Accessories: Satin white glass

◀ Item **CDF05**  
Led chandelier





◀ Item **CDF04**  
Led chandelier  
Finish: Satin gold  
Accessories: Clear glass

Softness  
and **strength.**  
Sensuality and  
character



CDF



▲ Item **CDF05**  
Led chandelier  
Finish: Polished nickel  
Accessories: Clear glass

Love  
at **first**  
sight

Love at first sight between glass and metal.  
A light cascade suited for a vertical or horizontal  
development, according to the needs.  
One, two or many elements. The imperfect,  
organic and sinuous lines of the hand blown  
glass are contrasted by a metallic modular  
structure.  
Softness and strength. Sensuality and character.



▲ Item **CDF04**  
Led chandelier  
Finish: Satin gold  
Accessories: Satin white glass

# collection

Item **CDF05**  
L.148 x D.53 cm  
H.69 cm min - 204 cm max

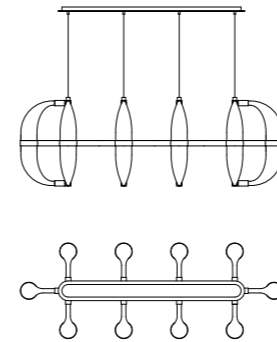

Item **CDF01**  
L.53 x D.53 cm  
H.69 cm min - 204 cm max

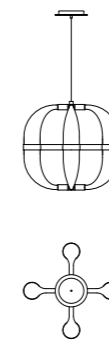

Item **CDF02**  
L.53 x D.20 cm  
H.69 cm min - 204 cm max

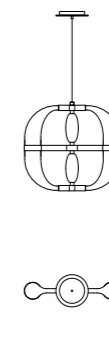

Item **CDF03**  
L.53 x D.53 cm  
H.115 cm min - 250 cm max

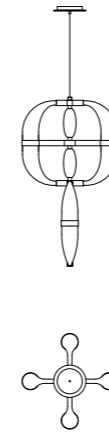

Item **CDF04**  
L.53 x D.53 cm  
H.207 cm min - 342 cm max

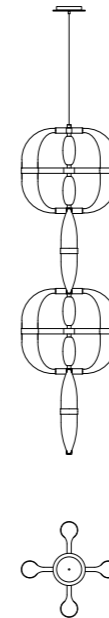

▲ Item **CDF01**  
Led chandelier  
Finish: Gunmetal  
Accessories: Satin white glass



▲ Item **CDF01**  
Led chandelier  
Finish: Gold plated  
Accessories: Amber glass



▲ Item **CDF02**  
Led chandelier  
Finish: Polished nickel  
Accessories: Clear glass



▲ Item **CDF02**  
Led chandelier  
Finish: Polished nickel  
Accessories: Satin amber glass

metal finishes



polished nickel



gunmetal



gold plated



satin gold

blown glass colour



satin white

clear



satin amber

amber

designer ROBERTO LAZZERONI

# Novecento

year: 2011

The peculiarity that makes this collection unique is the lampshade and its particular shape.



▲ Item Novecento EX01  
24 lights chandelier  
Finish: Satin brass  
Lampshades: White string

◀ Item N0901  
6 lights suspension lamp  
Finish: Satin brass  
Lampshades: Brown eco  
leather



▲ Item **N01N1**  
10 lights suspension lamp  
Finish: Satin nickel  
Lampshades: Brown eco leather

## Dancing *chandeliers*

The peculiarity that makes this collection unique is the lampshade and its particular shape: available in brown eco leather and white string. A system of repeating proportions and modules, wisely assembled by the experts hands of the artisans. The collection consists of a large number of models developed horizontally and vertically.



▲ Item **N1101**  
4 lights suspension lamp  
Finish: Satin brass  
Lampshade: Brown eco leather

◀ Item **N11N3**  
4 lights suspension lamp  
Finish: Satin nickel  
Lampshade: White string

▼ Item **N06N1**  
2 lights wall lamp

▼ Item **N07N1**  
1 light wall lamp

▼ Item **N06O3**  
2 lights wall lamp

▼ Item **N07O3**  
1 light wall lamp



◀ Item **N16O1**  
1 light table lamp  
Finish: Satin brass  
Lampshade: Brown eco leather



◀ Item **N15O1**  
1 light table lamp  
Finish: Satin brass  
Lampshade: Brown eco leather

A system of repeating proportions and modules, wisely assembled by the experts hands of the *artisans*

▶ Item **N17O3**  
1 light floor lamp  
Finish: Satin brass  
Lampshade: White string



# collection

Item **Novecento EX01**

Ø 130 cm  
H.320 cm

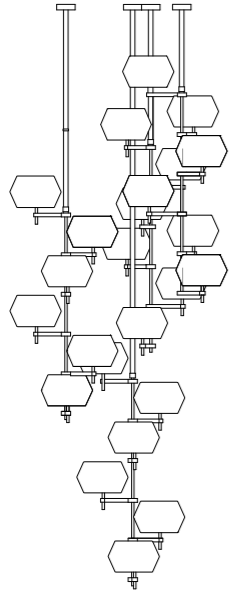

Item **Novecento EX03**

L.125 x D.125 cm  
H.80 cm min - 115 cm max

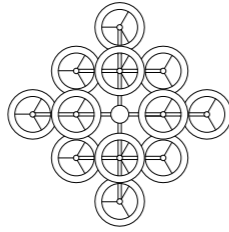
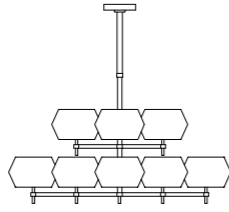

Item **Novecento EX02**

Ø 120 cm  
H.90 cm min - 150 cm max

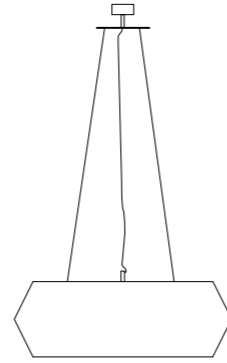

Item **N13**

L.48 x D.28 cm  
H.52 cm min - 157 cm max



Item **N08**

L.76 x D.76 cm  
H.140 cm min - 172 cm max

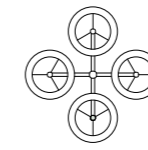
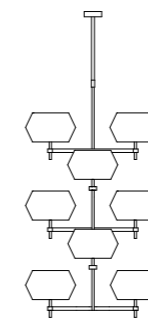

Item **N09**

L.59 x D.59 cm  
H.161 cm min - 193 cm max

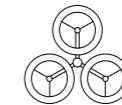
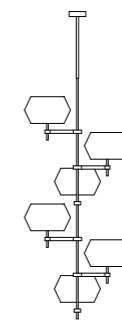

Item **N07**

L.28 x D.30 cm  
H. 26 cm



Item **N06**

L.65 x D.34 cm  
H. 26 cm

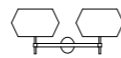

Item **N12**

L.55 x D.42 cm  
H.72 cm min - 157 cm max

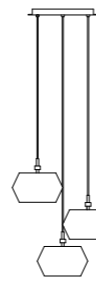

Item **N11**

Ø 67 cm  
H.40 cm min - 135 cm max

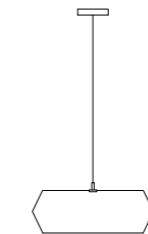

Item **N14**

Ø 28 cm  
H.32 cm min - 127 cm max

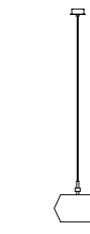

Item **N01**

L.174 x D.63 cm  
H.53 cm min - 89 cm max

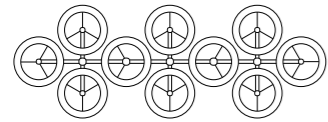
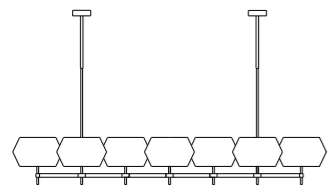

Item **N02**

L.106 x D.63 cm  
H.53 cm min - 89 cm max

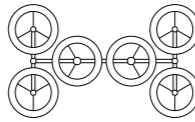
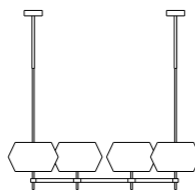

Item **N03**

L.136 x D.63 cm  
H.74 cm min - 110 cm max

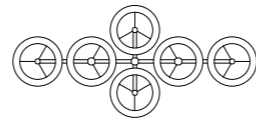
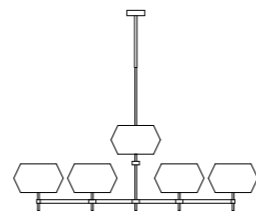

Item **N04**

L.76 x D.63 cm  
H.95 cm min - 131 cm max

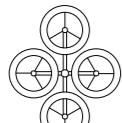
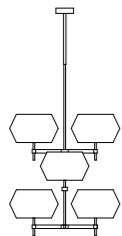

Item **N05**

L.63 x D.63 cm  
H.74 cm min - 110 cm max

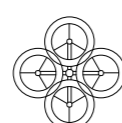
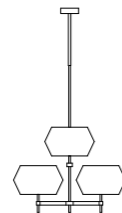

Item **N10**

L.63 x D.28 cm  
H.75 cm min - 107 cm max

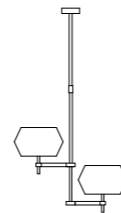

Item **N17**

Ø 56 cm  
H.165 cm



Item **N16**

Ø 28 cm  
H.72 cm



Item **N15**

Ø 23 cm  
H.40 cm



satin brass



satin nickel



antiqued silver plated



brown eco leather



white string

metal finishes

lampshades





Reflections  
and *refractions*

Perky, translucent and  
precious.  
A well thought mix of  
classic elegance and  
lighting design efficiency  
born from the synergy  
between two designers  
and their visionary ability  
to imagine fascinating and  
faraway worlds.



Item **Novecento EX04**

Ø130 cm

H.320 cm

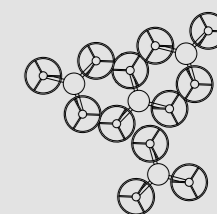
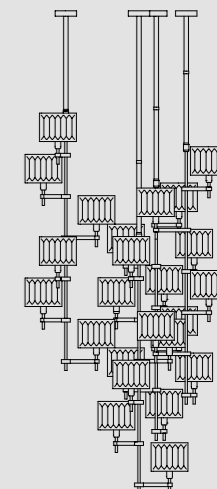

lampshades



clear crystals

metal  
finishes



satin nickel



antiqued silver plated



gold plated



satin brass

designer ROBERTO LAZZERONI

# Angie

year: 2013

Whatever your choice is, Angie will always know what to say

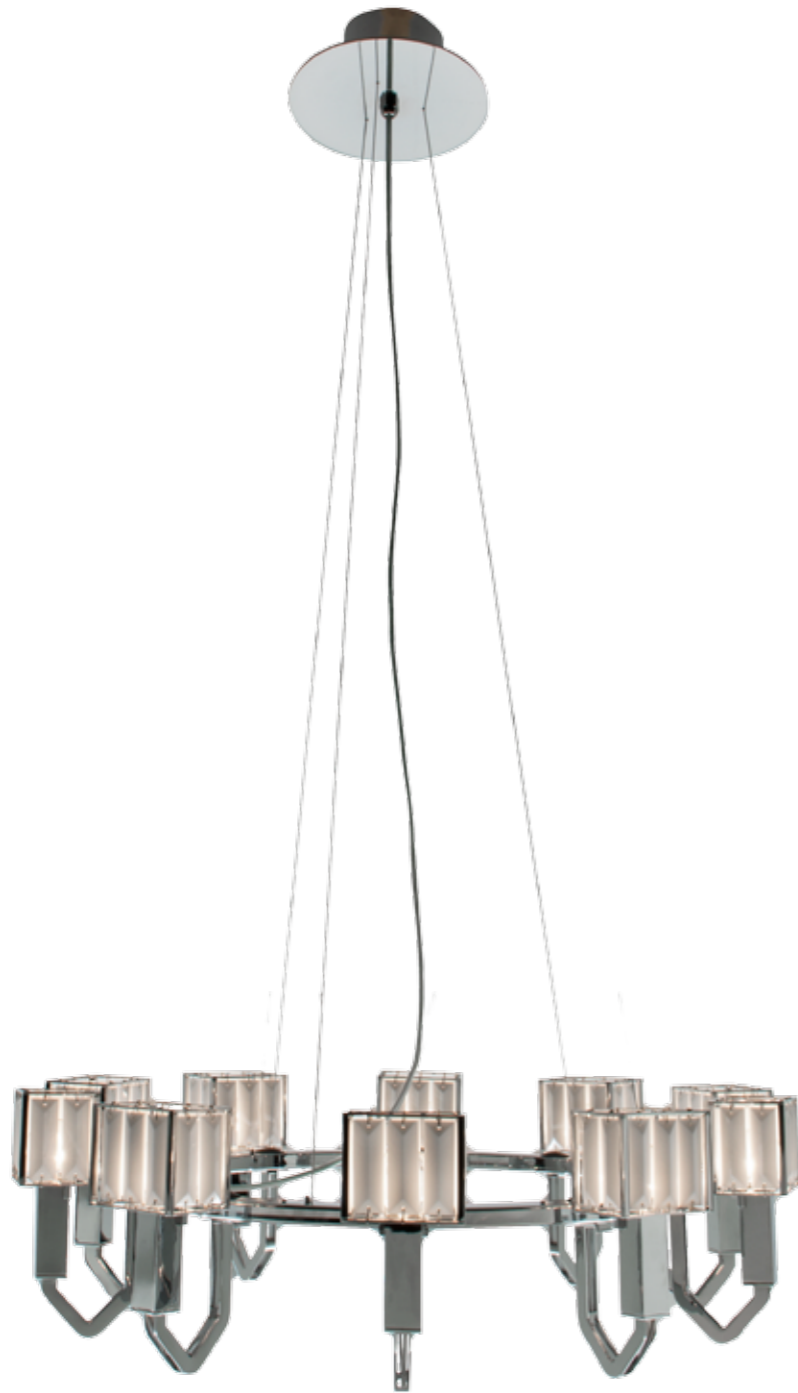

▲ Item **Angie EX01**  
55 lights chandelier  
Finish: Chrome  
Lampshades: Clear  
crystals

◀ Item **A06C2**  
10 lights chandelier  
Finish: Chrome  
Lampshades: White  
crystals

# A merry-go-round of geometries



▲ Item **A11C1**  
1 light wall lamp

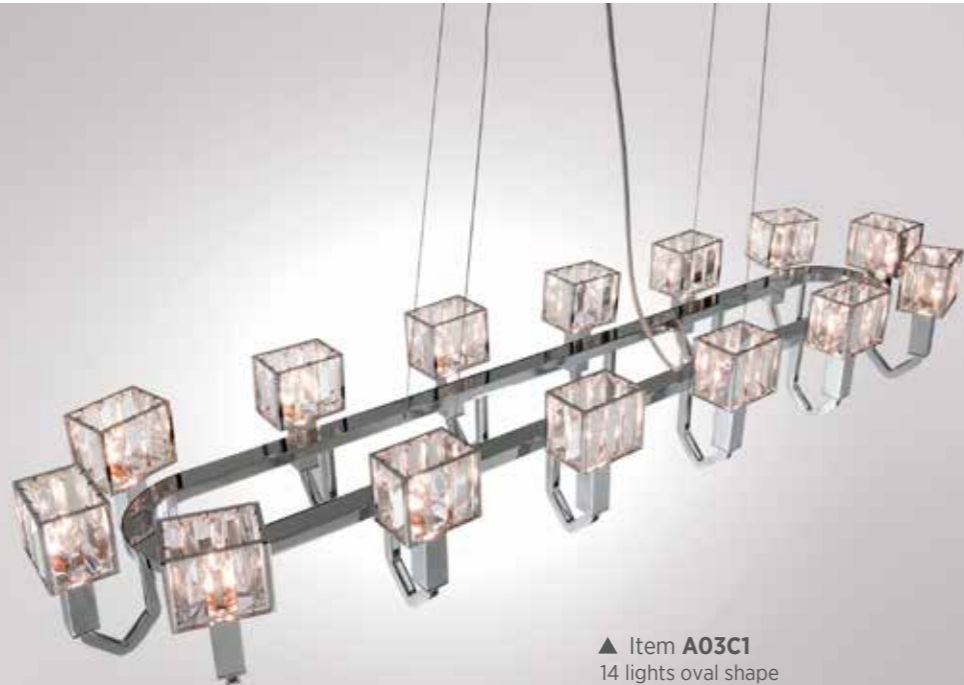

▲ Item **A03C1**  
14 lights oval shape chandelier



▲ Item **A09C1**  
3 lights wall lamp  
Finish: Chrome  
Lampshades: Clear crystals



▲ Item **A13C1**  
5 lights floor lamp  
Finish: Chrome  
Lampshades: Clear crystals



◀ Item **A12C1**  
5 lights table lamp  
Finish: Chrome  
Lampshades: Clear crystals



# collection

Item **Angie EX01**  
 Ø 128 cm  
 H.290 cm max

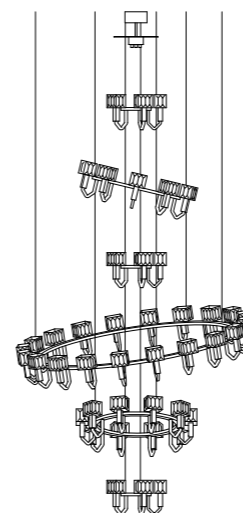

Item **A05**  
 Ø 128 cm  
 H.70 cm min - 133 cm max

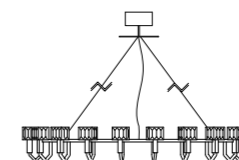

Item **A06**  
 Ø 64 cm  
 H.60 cm min - 140 cm max

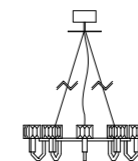

Item **A07**  
 Ø 34 cm  
 H.50 cm min - 140 cm max



Item **Angie EX02**  
 L.85 x D.85 cm  
 H.110 cm min - 169 cm max

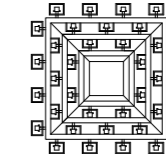
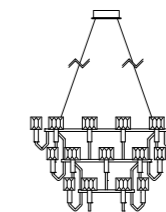

Item **A09**  
 L.27 x D.13 cm  
 H.30 cm



Item **A08**  
 L.10 x D.8 cm  
 H.37 cm



Item **A12**  
 Ø 34 cm  
 H.64 cm

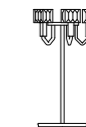

Item **A13**  
 Ø 34 cm  
 H.170 cm



Item **A10**  
 L.21 x D.13 cm  
 H.20 cm



Item **A11**  
 L.11 x D.13 cm  
 H.20 cm



Item **A01**  
 L.157 x D.65 cm  
 H.70 cm min - 133 cm max

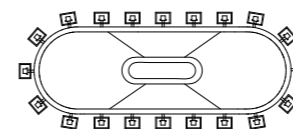
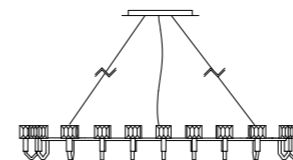

Item **A02**  
 L.119 x D.65 cm  
 H.70 cm min - 133 cm max

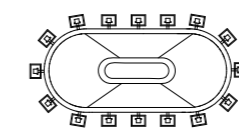
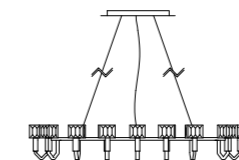

Item **A03**  
 L.128 x D.33 cm  
 H.60 cm min - 140 cm max

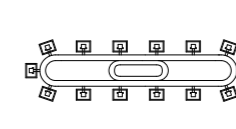
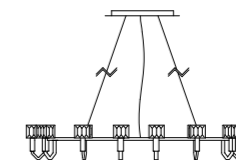

Item **A04**  
 L.85 x D.33 cm  
 H.60 cm min - 140 cm max

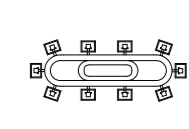
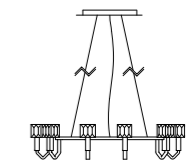

Angie knows what it wants.  
 Born out of a reinterpretation of the Holly collection,  
 in 2011, it choses to recount itself, aesthetically speaking, in a lighter, more modern and linear way.  
 Whatever your choice is, Angie will always know what to say.

Item **A05G1**  
 20 lights chandelier  
 Finish: Gold plated  
 Lampshades:  
 Clear crystals

Composition of:  
 Item **A01G1**  
 20 lights oval shape chandelier,  
 Item **A05G1**,  
 Item **A02G1**  
 16 lights oval shape chandelier



## metal finishes



chrome



gunmetal



gold plated

## lampshades



clear crystals



white crystals

designer ROBERTO LAZZERONI

## Gisele

year: 2013

An innovative design, despite the appearances,  
which combines technology  
with aesthetic reasons



◀ Item **G01N1**  
Led chandelier  
Finish: Satin nickel  
Accessories: Clear crystals



◀ Item **Gisele EX05\_M** ▶  
 Led wall lamp  
 Finish: Gunmetal  
 Accessories: Clear crystals

Like a  
***luminous***  
 choreography



▲ Item **G01N1**  
 Led chandelier

Gisele dances.  
 Gisele doesn't improvise her moves, she studies them, repeats them, perfects them.  
 The main feature of the collection is, beside the preciousness of its components, the ease to create new shapes and dimensions.  
 An innovative design, despite the appearances, which combines technology with aesthetic reasons: the entire structure is created in laser-cut steel and the lights are dimmable leds.



▲ Item **Gisele EX12\_M**  
 Led chandelier with rods



▲ Item **Gisele EX02\_O**  
Led chandelier  
Finish: Satin brass  
Accessories: Clear crystals

◀ Item **Gisele EX10\_G**  
Led chandelier  
Finish: Gold plated  
Accessories: Clear crystals



Gisele  
*dances...*



◀ Item **Gisele EX16\_O**  
Led chandelier  
Finish: Satin brass  
Accessories: Clear crystals

▼ Item **Gisele EX04\_G**  
Led wall lamp  
Finish: Gold plated  
Accessories: Clear crystals



just like a  
*dancer...*

▲ Item **Customized Gisele EX17\_G & Gisele EX18\_G**  
Led circular chandeliers  
Finish: Gold plated  
Accessories: Clear crystals



# collection

Item **Gisele EX01**  
L.260 x D.50 cm  
H.45 cm min - 138 cm max

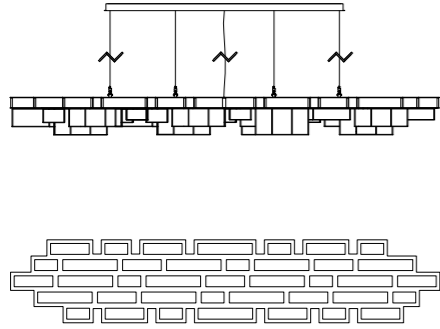

Item **Gisele EX02**  
L.130 x D.100 cm  
H.45 cm min - 138 cm max

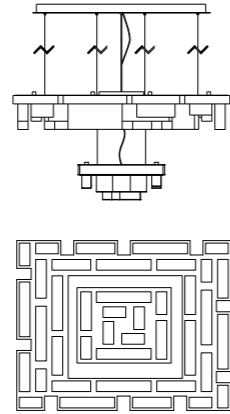

Item **Gisele EX06**  
L.160 x D.160 cm  
H.80 cm min - 200 cm max

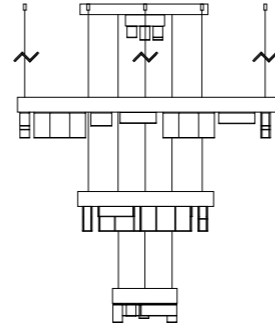

Item **Gisele EX07**  
L.300 x D.60 cm  
H.45 cm min - 138 cm max

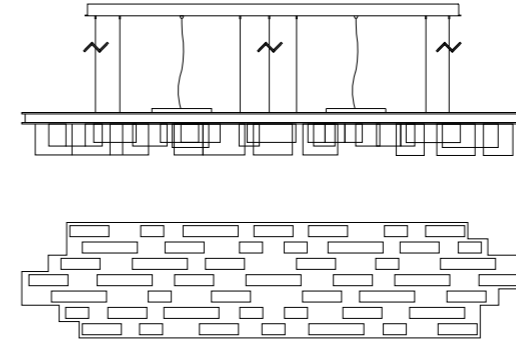

Item **Gisele EX16**  
L.196 x D.50 cm  
H.45 cm min - 138 cm max

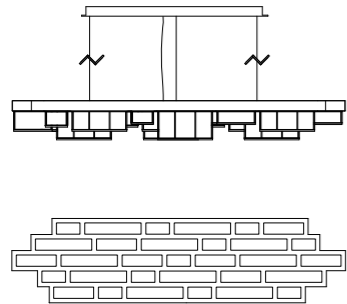

Item **Gisele EX09**  
L.135 x D.50 cm  
H.45 cm min - 138 cm max

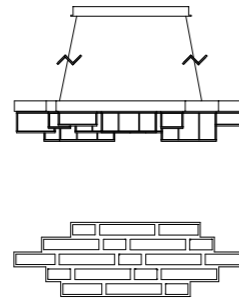

Item **Gisele EX10**  
L.100 x D.100 cm  
H.45 cm min - 138 cm max

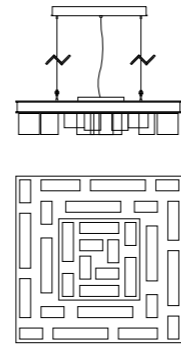

Item **Gisele EX17**  
Ø 140 cm  
H.38 cm min - 138 cm max

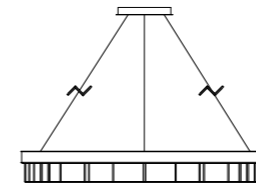

Item **Gisele EX14**  
Ø 83 cm  
H.17 cm

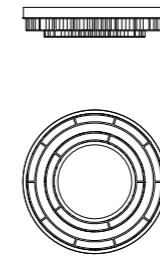

Item **Gisele EX08**  
L.196 x D.30 cm  
H.45 cm min - 138 cm max

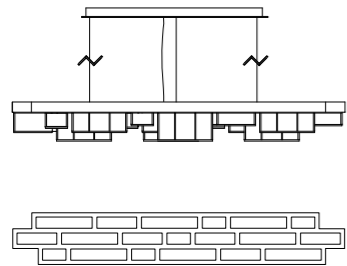

Item **G01**  
L.135 x D.30 cm  
H.45 cm min - 138 cm max

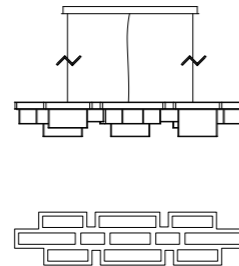

Item **Gisele EX12**  
L.183x D.60 cm  
H.45 cm

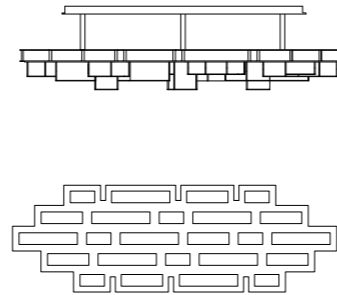

Item **Gisele EX18**  
Ø 100 cm  
H.38 cm min - 138 cm max

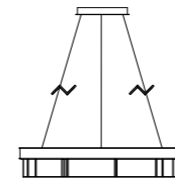

Item **Gisele EX04**  
L.26 x D.22 cm  
H.63 cm

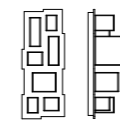

Item **G02**  
L.81 x D.30 cm  
H.45 cm min - 138 cm max

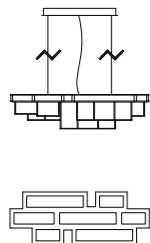

Item **Gisele EX11**  
L.54 x D.45 cm  
H.45 cm min - 138 cm max

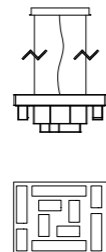

Item **Gisele EX13**  
L.145 x D.45 cm  
H. 23 cm

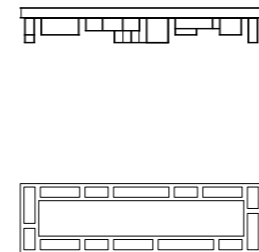

Item **Gisele EX05**  
L.60 X D.18 cm  
H.64 cm

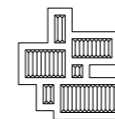

Item **Gisele EX15**  
L.35 X D.15 cm  
H.24 cm

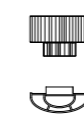

satin brass



gold plated



satin nickel



gunmetal



clear crystals

metal finishes

lampshades

designer PATRIZIA GARGANTI

# Tur

year: 2015

An ensemble of parallelepipeds of various heights made of transparent crystal lozenges, hand-assembled over a metallic chassis



◀ Item **Tur EX10\_N custom**  
44 lights chandelier  
Finish: Polished nickel  
Lampshades: Clear crystals



▲ Item **Tur EX06\_O**  
**custom**  
 44 lights chandelier  
 Finish: Burnished brass &  
 satin brass details  
 Lampshades: Clear crystals

# The precious **modularity**



▲ Item **Tur EX09\_O**  
 44 lights chandelier  
 Finish: Satin brass  
 Lampshades: Clear  
 crystals



◀ Item **Tur EX07\_O** ▶  
 7 lights wall lamp  
 Finish: Satin brass  
 Lampshades: Clear crystals



▼ Item **Tur EX08\_O**  
**custom**  
 38 lights chandelier  
 Finish: Burnished brass &  
 satin brass details  
 Lampshades: Clear crystals





▲ **Item Tur EX18**  
15 lights ceiling lamp  
Finish: Gold leaf & gold plated details  
Lampshades: Clear crystals

▼ **Item Tur EX17**  
13 lights ceiling lamp  
Finish: Gold leaf & gold plated details  
Lampshades: Clear crystals

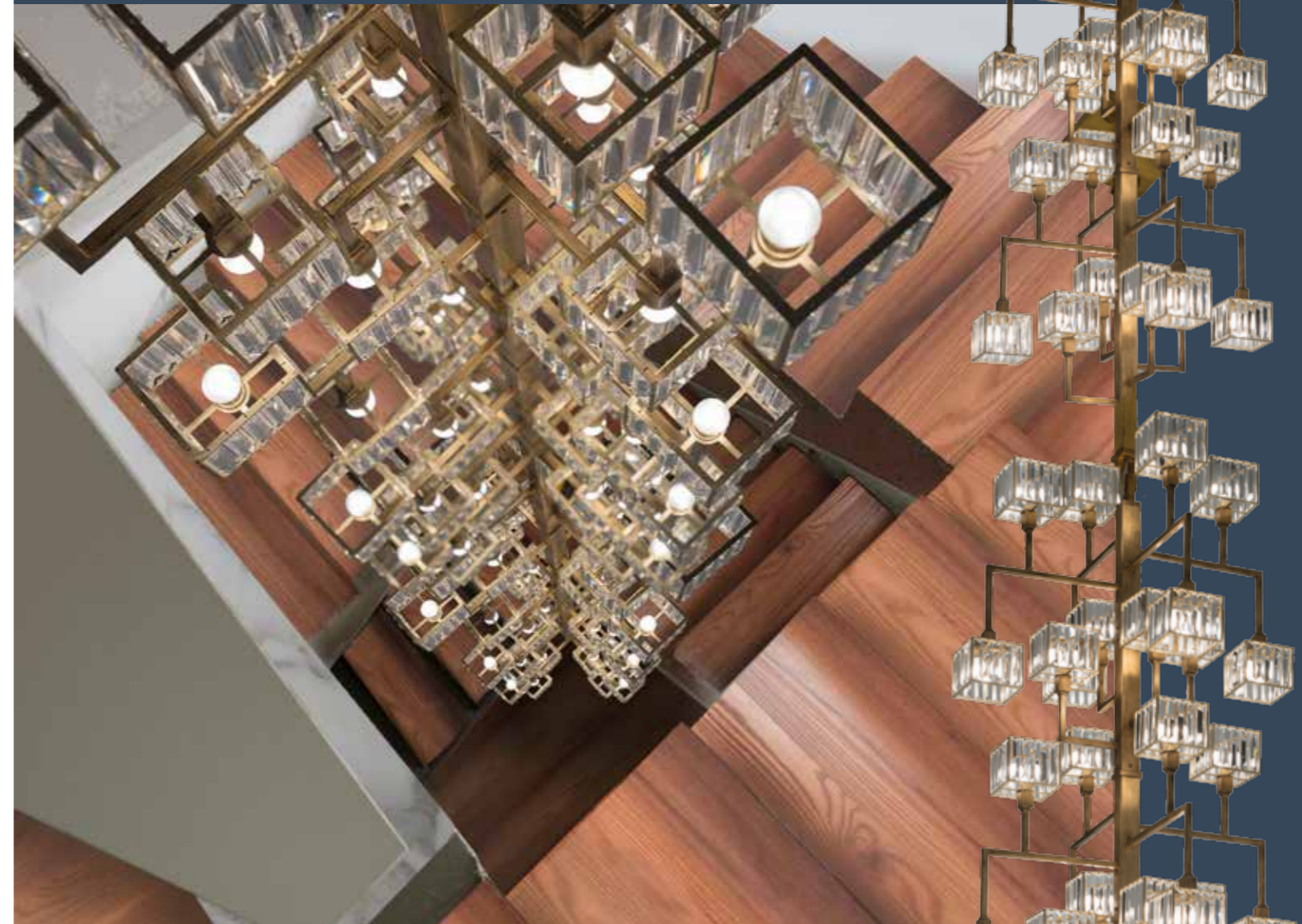

The peculiarity of the collection lies in the high number of possible combinations and the ease in creating new forms and dimensions due to the repetitions of the crystal module: an ensemble of parallelepipeds of various heights made of transparent crystal lozenges, hand-assembled over a metallic chassis.

▶ **Item Tur EX11\_O custom**  
72 lights chandelier  
Finish: Satin brass  
Lampshades: Clear crystals



# collection

Item **Tur EX04**  
L.130 x D.78 cm  
H.50 cm min - 130 max

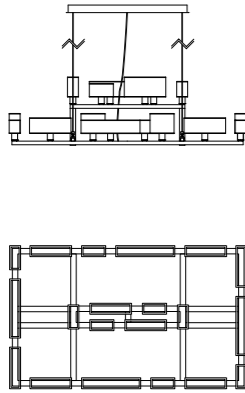

Item **Tur EX01**  
L.130 x D.78 cm  
H.85 cm min - 168 max

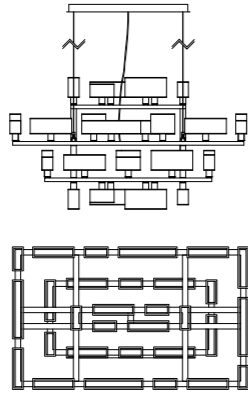

Item **Tur EX05**  
L.95 x D.44 cm  
H.50 cm min - 130 max

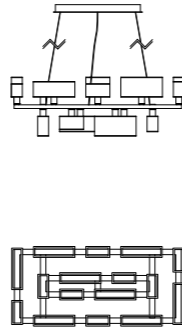

Item **Tur EX07**  
L.34 x D.22 cm  
H.60 cm



Item **Tur EX09**  
L.160 x D.160 cm  
H.65 cm min - 170 max

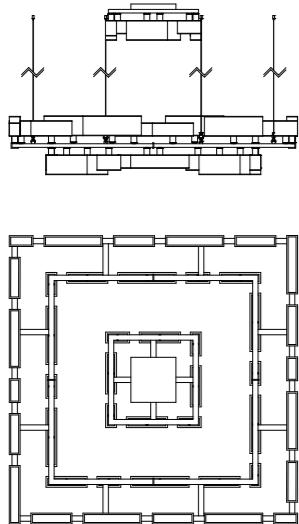

Item **Tur EX02**  
L.210 x D.78 cm  
H.85 cm min - 168 max

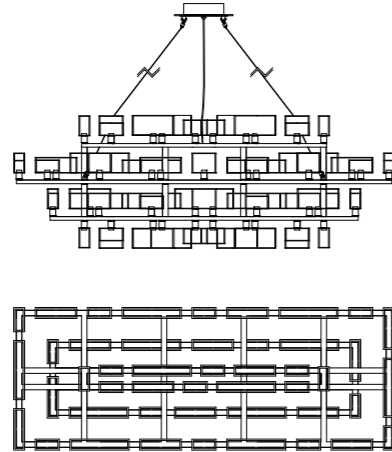

Item **Tur EX03**  
L.172 x D.44 cm  
H.50 cm min - 130 max

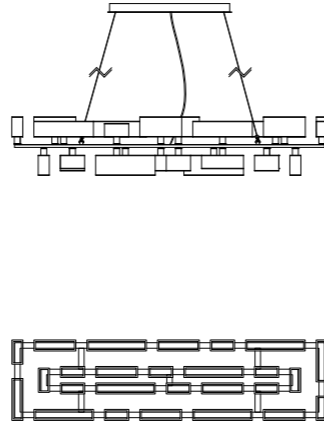

Item **Tur EX06**  
L.120 x D.120 cm  
H.85 cm min - 168 max

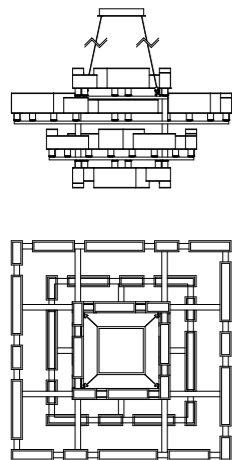

Item **Tur EX08**  
L.270 x D.63 cm  
H.50 cm min - 150 max

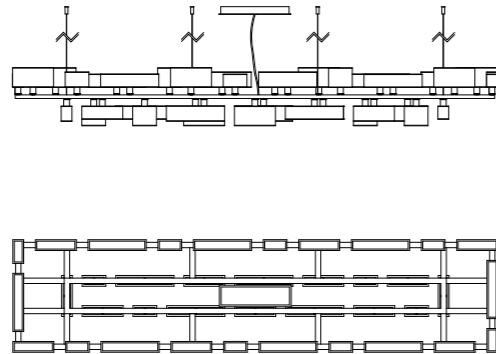

Item **Tur EX18**  
L.120 x D.80 cm  
H.60 cm

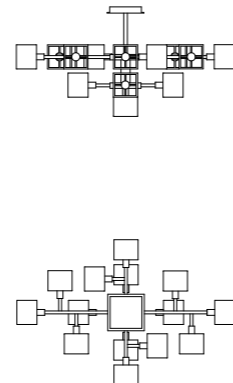

Item **Tur EX10**  
L.330 x D.170 cm  
H.120 cm min - 200 max

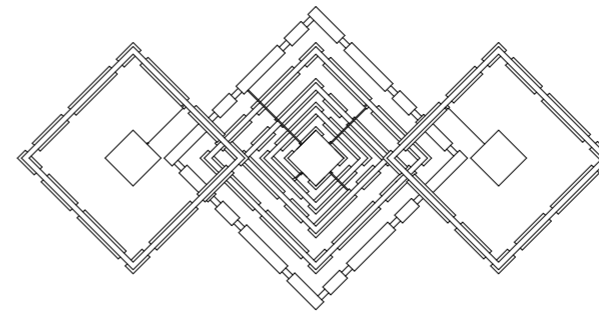
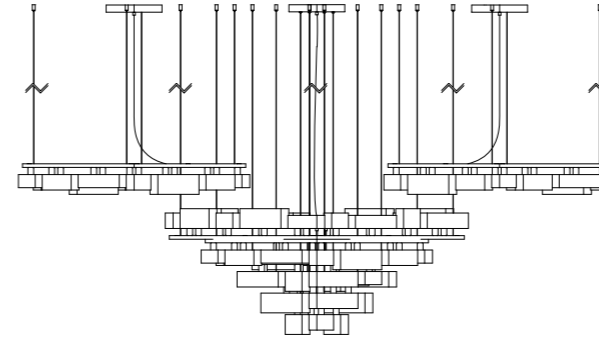

Item **Tur EX12**  
L.120 x D.120 cm  
H.40 cm min - 160 max

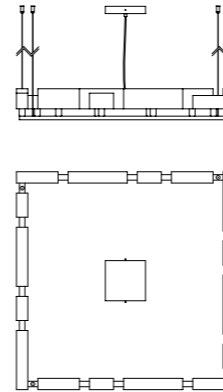

Item **Tur EX13**  
L.90 x D.90 cm  
H.40 cm min - 160 max

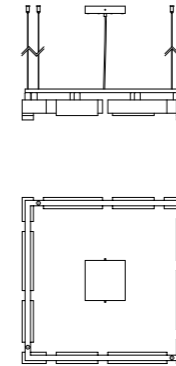

Item **Tur EX14**  
L.62 x D.62 cm  
H.40 cm min - 160 max

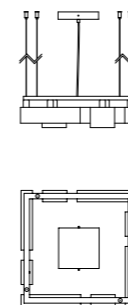

Item **Tur EX15**  
L.44 x D.44 cm  
H.40 cm min - 160 max

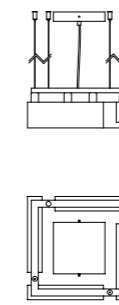

Item **Tur EX11**  
L.80 x D.80 cm  
H.400 cm

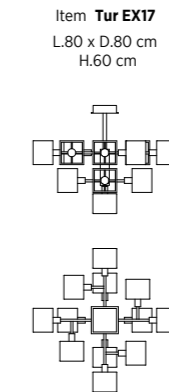
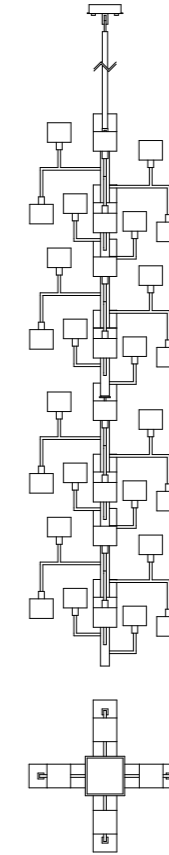

Item **Tur EX16**  
L.25 x D.25 cm  
H.40 cm min - 160 max



satin brass



polished nickel



gold leaf & gold plated details



clear crystals

metal finishes

lampshades

designer ROBERTO LAZZERONI

# Holly

year: 2011

The modules, set ajar, look like precious gems variously mounted just like bracelets, rings or parures.



▲ Item **H04M4**  
20 lights chandelier  
Finish: Gunmetal  
Lampshades: White silk

◀ Item **H01G8**  
35 lights chandelier  
Finish: Gold plated  
Lampshades: Cutted  
clear pearls



▲ Item **H01C5**  
35 lights chandelier  
Finish: Chrome  
Lampshades: Dove grey silk



▶ Item **H10C4**  
15 lights floor lamp  
Finish: Chrome  
Lampshades: White silk



▶ Item **H08C4**  
10 lights table lamp  
Finish: Chrome  
Lampshades: White silk

▶ Item **H04M1**  
20 lights chandelier  
Finish: Gunmetal  
Lampshades: White pearls

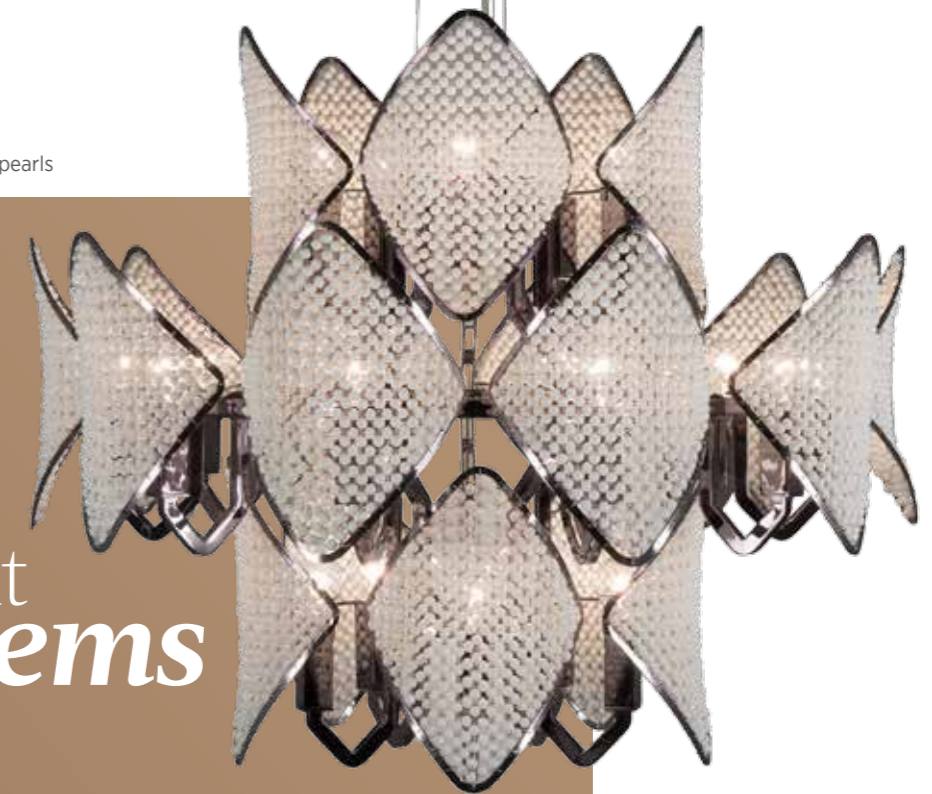

## Light gems

The different models are obtained by arranging the rhombuses over ring-like elements of different diameters and remind of top level goldworking. The modules, set ajar, look like precious gems variously mounted just like bracelets, rings or parures. The choice of color nuances and metallic finishes is thought to always obtain combinations that glorify the preciousness of the artifact.

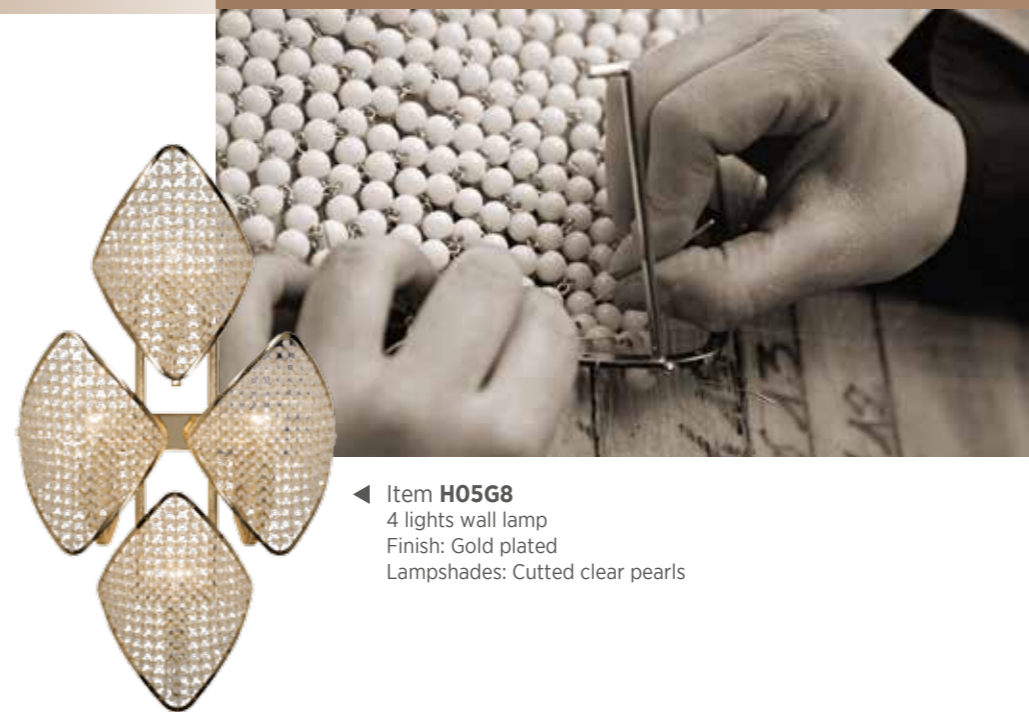

◀ Item **H05G8**  
4 lights wall lamp  
Finish: Gold plated  
Lampshades: Cutted clear pearls

# collection

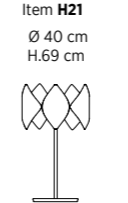
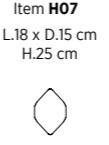
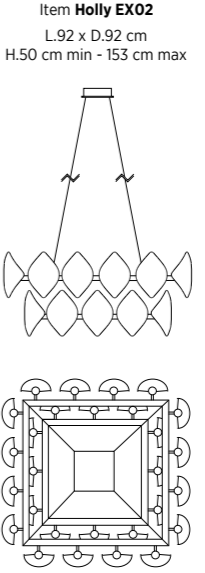
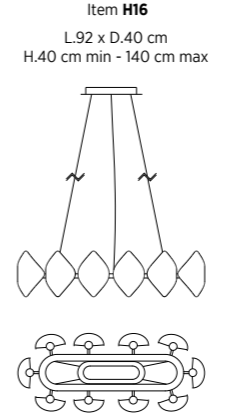
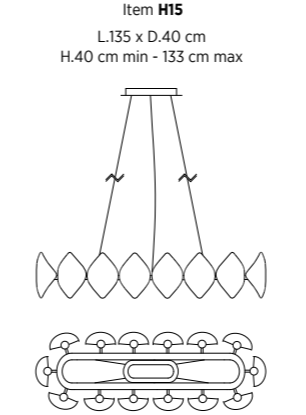
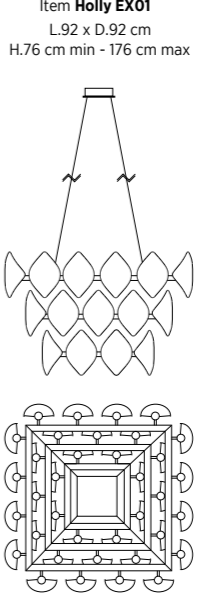
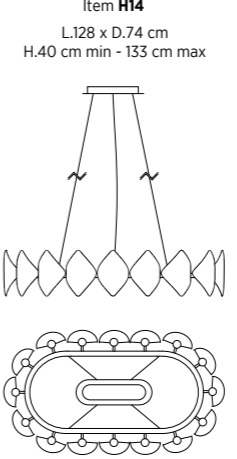
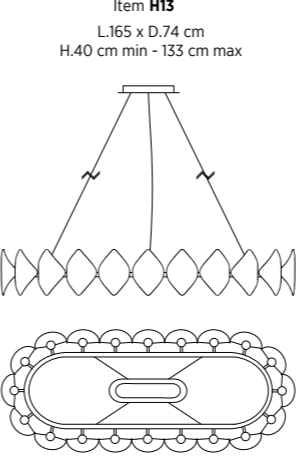
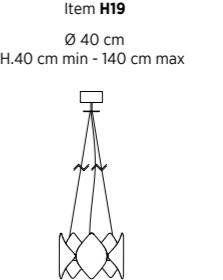
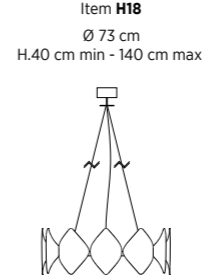
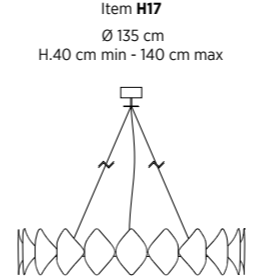
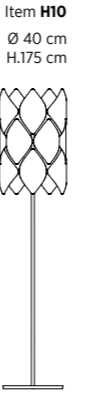
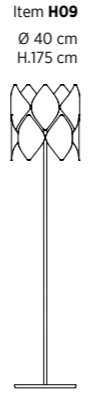
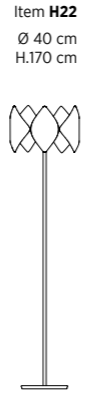
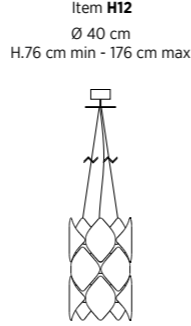
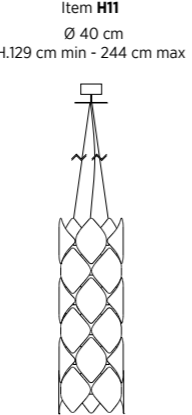
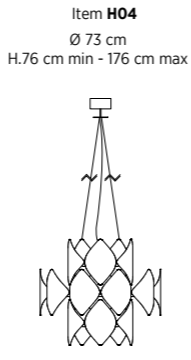
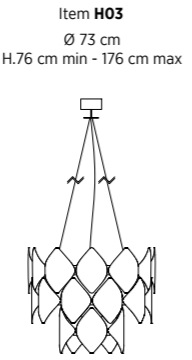
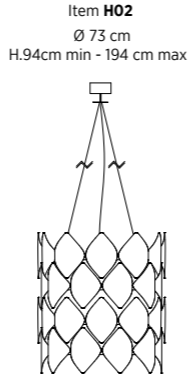
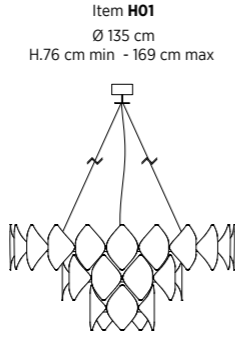

▲ **Item H12C8**  
 15 lights chandelier  
 Finish: Chrome  
 Lampshades: Cutted clear pearls

# lampshades



white silk



dove grey silk



cutted clear pearls



white pearls



black pearls



gold plated



chrome



gunmetal

# metal finishes



designer ROBERTO LAZZERONI

## Frozen

year: 2011

A cold light, full of reflections, well suited for contemporary and sophisticated locations.



▲ Item **F01N1**  
6 lights suspension lamp  
Finish: Satin nickel  
Accessories: Clear crystals

◀ Item **F02N1**  
4 lights suspension lamp

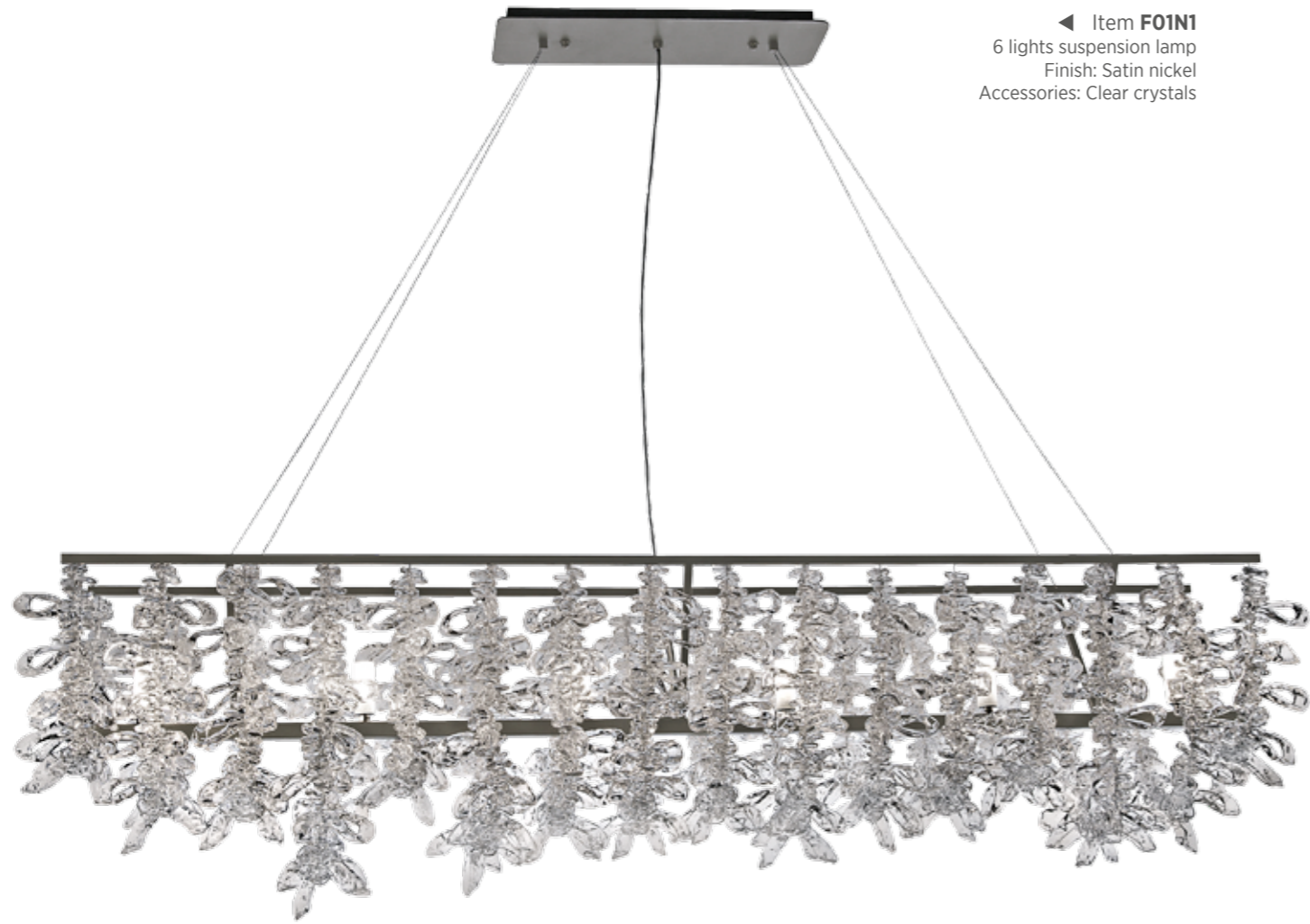

◀ Item **F01N1**  
6 lights suspension lamp  
Finish: Satin nickel  
Accessories: Clear crystals

# Arctic Light

A linear metallic structure supports an exuberant game of intertwined ice sculptures: hand-made in Venice, these elements in blown glass, each one different from the other, find their strong point in their imperfection. Masculine and feminine. Minimalist and baroque. A cold light, full of reflections, well suited for contemporary and sophisticated locations.



▲ Item **F03G1**  
2 lights suspension lamp  
Finish: Gold plated  
Accessories: Clear crystals

A cold light, full of **reflections**, well suited for contemporary and sophisticated **locations**

## collection

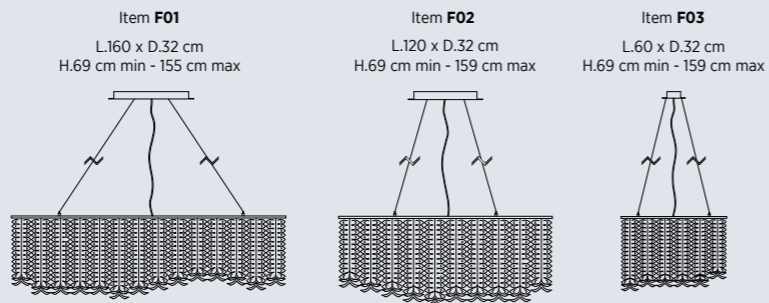

### metal finishes

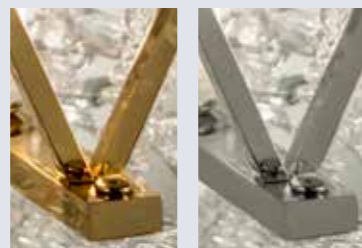

gold plated      satin nickel

### accessories



clear crystals

designer PATRIZIA GARGANTI

## Dew

year: 2017

Hand braided leather and crystal reflections  
combined with a contemporary design create a unique  
and sophisticated style.



▲ Item **D01**  
24 lights chandelier  
Finish: Gunmetal & copper details  
Lampshades: Clear crystal pearls  
Accessories: Peach leather



Hand braided  
leather  
& crystal  
reflections



▲ Item D01  
24 lights chandelier  
Finish: Gunmetal & polished nickel details  
Lampshades: Clear crystal pearls  
Accessories: Black leather



▲ Item D16  
24 lights chandelier  
Finish: Gunmetal & copper details  
Lampshades: Black silk  
Accessories: Peach leather



Item D08 ▶  
1 light floor lamp  
Finish: Gunmetal & polished nickel details  
Lampshade: Black silk  
Accessories: Black leather

▲ Item D10  
1 light table lamp  
Finish: Burnished brass & satin gold details  
Lampshade: T24 cat.C  
Accessories: Brown leather

▲ Item D10  
1 light table lamp  
Finish: Gunmetal & copper details  
Lampshade: Black silk  
Accessories: Peach leather



▲ Item **D03**  
 16 lights chandelier  
 Finish: Satin brass & gold plated details  
 Lampshades: Clear crystals  
 Accessories: White leather



▲ Item **D18**  
 16 lights chandelier  
 Finish: Gunmetal & polished nickel details  
 Lampshades: Black silk  
 Accessories: Lime leather



## Drops of Memory



An incomparable artisan mastery typical of our land it's the distinguishing feature of this collection. Hand braided leather and crystal reflections combined with a contemporary design create a unique and sophisticated style.



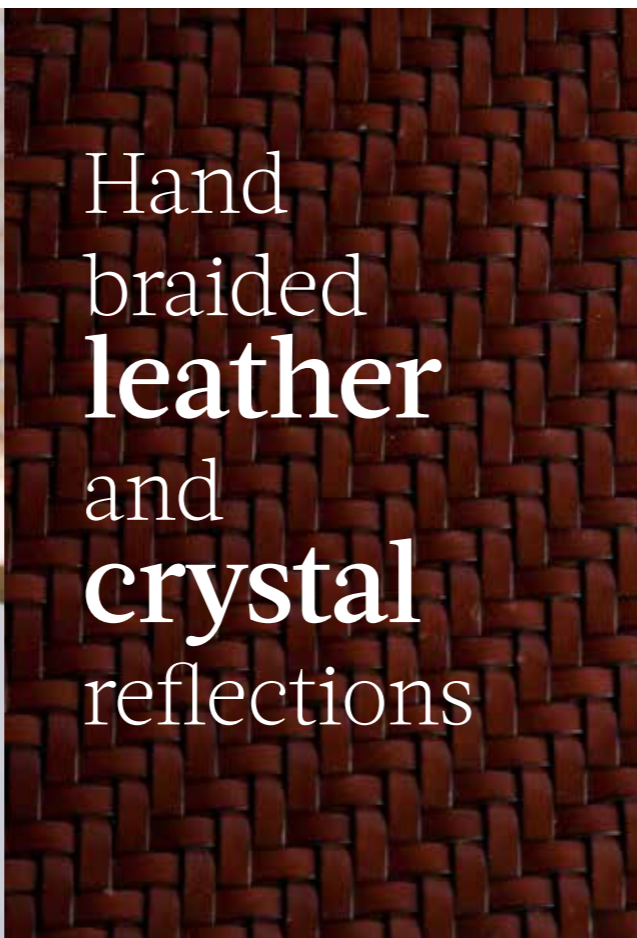

Hand  
braided  
**leather**  
and  
**crystal**  
reflections



◀ Item **D04**  
24 lights chandelier  
Finish: Burnished brass &  
satin gold details  
Lampshades: Clear crystal pearls  
Accessories: Brown leather



▲ Item **D05** ▲  
3 lights wall lamp  
Finish: Gunmetal & polished nickel details  
Lampshades: Clear crystal pearls  
Accessories: Black leather



▲ Item **D07**  
1 light wall lamp  
Finish: Gunmetal & polished nickel details  
Lampshade: Clear crystal pearls  
Accessories: Black leather



▲ Item **D06**  
2 lights wall lamp  
Finish: Burnished brass & satin gold details  
Lampshades: Clear crystal pearls  
Accessories: Brown leather



▲ Item **D20** ▲  
3 lights wall lamp  
Finish: Gunmetal & polished nickel details  
Lampshades: Black silk  
Accessories: Lime leather



# collection



<p><b>Item D01</b> Ø 120 cm H.80 cm min</p>	<p><b>Item D02</b> Ø 70 cm H.80 cm min</p>	<p><b>Item D16</b> Ø 120 cm H.80 cm min</p>	<p><b>Item D17</b> Ø 70 cm H.80 cm min</p>
<p><b>Item D03</b> Ø 70 cm H.110 cm min</p>	<p><b>Item D04</b> L.160 x D.70cm H.80 cm min</p>	<p><b>Item D18</b> Ø 70 cm H.110 cm min</p>	<p><b>Item D19</b> L.160 x D. 70cm H.80 cm min</p>

<p><b>Item Dew EX01</b> L.182 x D.98 cm H.100 cm</p>	<p><b>Item D05</b> L.30 x D.25 cm H.48 cm</p>	<p><b>Item D06</b> L.33 x D.26 cm H.37 cm</p>	<p><b>Item D07</b> L.12 x D.23 cm H.48 cm</p>
	<p><b>Item D20</b> L.30 x D.25 cm H.46 cm</p>	<p><b>Item D21</b> L.33 x D.26 cm H.35 cm</p>	<p><b>Item D22</b> L.12 x D.23 cm H.46 cm</p>

<p><b>Item D10</b> Ø 35 cm H.105 cm</p>	<p><b>Item D08</b> L.38 x D.72 cm H.175 cm</p>	<p><b>Item D09</b> Ø 44 cm H.190 cm</p>
---	--	---

## metal finishes



## fabric



## lampshades

## crystal

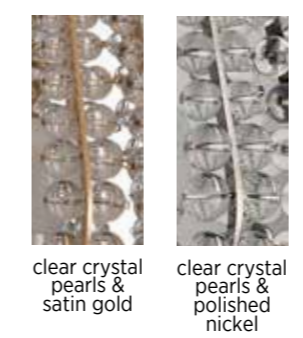

## lampshades



## accessories

designer PATRIZIA GARGANTI

# Burlesque

year: 2011

A collection capable of expressing a certain idea of femininity: mysterious, intense.



▲ Item **PG157**  
24 lights oval shape chandelier  
Finish: Champagne  
Lampshades & accessories:  
Smoky & clear crystals

◀ Item **PG103**  
36 lights chandelier





▲ Item **Burlesque EX05**  
6 lights ceiling lamp  
Finish: Champagne  
Accessories:  
Smoky & clear crystals

▼ Item **Burlesque EX04**  
16 lights ceiling lamp  
Finish: Gold leaf  
Accessories:  
Smoky & clear crystals

## Pearl *drapery...*

A drapery, some feathers, some precious gems: this is what comes to mind with Burlesque, a family of chandeliers with a strong personality. The protagonists here are the pearls with that multitude of precious strings that, just like a veil, lie down over the metallic structure of the lampshade, making it almost invisible. A collection capable of expressing a certain idea of femininity: mysterious, intense.



▲ Item **Burlesque EX09**  
55 lights chandelier  
Finish: Gold leaf  
Lampshades & accessories:  
Smoky & clear crystals



The protagonists here are the **pearls** with that multitude of ...

... **precious strings**



▲ Item **PG130**  
2 lights wall lamp  
Finish: Polished white  
Lampshades & accessories:  
White & clear crystals

◀ Item **PG136**  
12 lights ceiling lamp  
Finish: Polished white  
Accessories:  
White & clear crystals

▶ Item **PG262**  
6 lights chandelier  
Finish: Polished white  
Lampshades & accessories:  
White & clear crystals

▼ Item **PG181**  
5 lights wall lamp  
Finish: Champagne  
Lampshades & accessories:  
Smoky & clear crystals



▼ Item **PG235**  
18 lights chandelier  
Finish: Champagne  
Lampshades & accessories:  
Smoky & clear crystals



# collection

Item **Burlesque EX07**

Ø 185 cm  
H.220 cm min

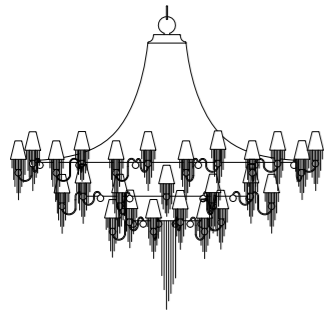

Item **Burlesque EX02 / EX09**

Ø 140 cm  
H.195 cm min

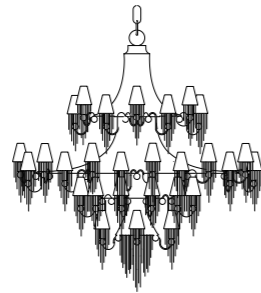

Item **PG100 / 105**

Ø 140 cm  
H.158 cm min

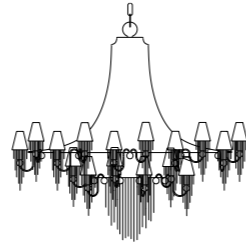

Item **Burlesque EX08**

L.160 x D.80 cm  
H.100 cm

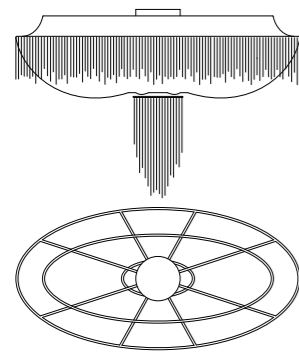

Item **PG166 / 171**

L.76 x D.55 cm  
H.77 cm

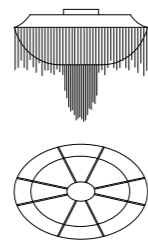

Item **PG172 / 177**

L.62 x D.40 cm  
H.59 cm



Item **PG106 / 111**

Ø 100 cm  
H.140 cm min

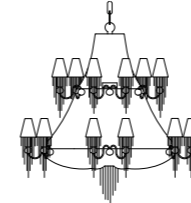

Item **PG112 / 117**

Ø 75 cm  
H.115 cm min

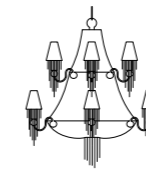

Item **PG118 / 123**

Ø 50 cm  
H.90 cm min



Item **PG154 / 159**

L.106 x D.82 cm  
H.130 cm min

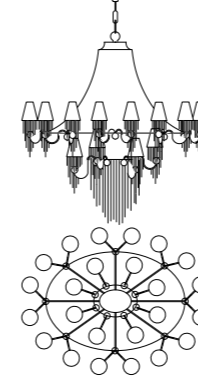

Item **PG160 / 165**

L.93 x D.72 cm  
H.121 cm min

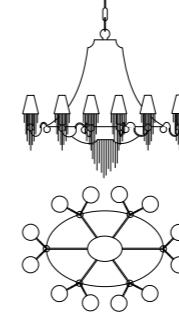

Item **PG280 / 285**

Ø 22 cm  
H.54 cm min - 169 max

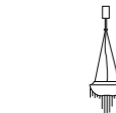

Item **Burlesque EX06**

L.80 x D.80 cm  
H.80 cm

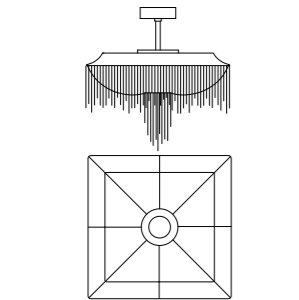

Item **Burlesque EX05**

L.60 x D.60 cm  
H.75 cm

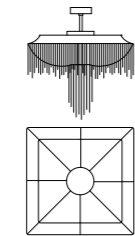

Item **Burlesque EX03**

L.53 x D.30 cm  
H.140 cm

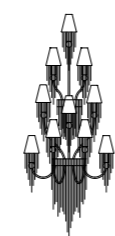

Item **PG232 / 237**

Ø 120 cm  
H.140 cm min

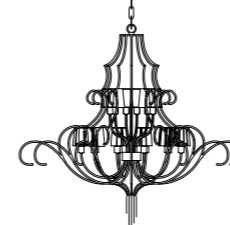

Item **PG238 / 243**

Ø 80 cm  
H.140 cm min

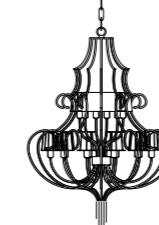

Item **PG244 / 249**

Ø 95 cm  
H.120 cm min

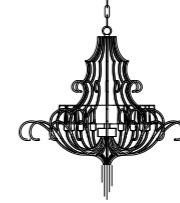

Item **PG136 / 141**

Ø 80 cm  
H.78 cm

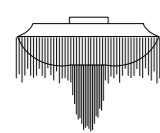

Item **PG142 / 147**

Ø 50 cm  
H.58 cm

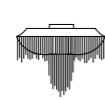

Item **PG148 / 153**

Ø 30 cm  
H.51 cm



Item **PG250 / 255**

Ø 60 cm  
H.120 cm min



Item **PG256 / 261**

Ø 70 cm  
H.110 cm min



Item **PG262 / 267**

Ø 46 cm  
H.110 cm min

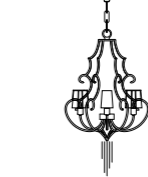

Item **PG124 / 129**

L.58 x D.30 cm  
H.56 cm

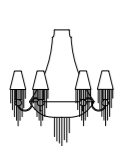

Item **PG130 / 135**

L.45 x D.18 cm  
H.51 cm

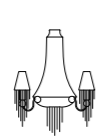

Item **PG292 / 297**

L.31 x D.31 cm  
H.110 cm min



Item **PG286 / 291**

Ø 12 cm  
H.70 cm min - 180 max



Item **PG220 / 225**

Ø 120 cm  
H.115 cm min



Item **PG226 / 231**

Ø 90 cm  
H.107 cm min



Item **PG274 / 279**

L.46 x D.24 cm  
H.60 cm

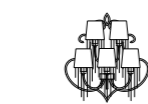

Item **PG178 / 183**

L.50 x D.16 cm  
H.40 cm



Item **PG184 / 189**

L.33 x D.22 cm  
H.63 cm



Item **PG190 / 195**

L.32 x D.22 cm  
H.40 cm



Item **PG196 / 201**

L.27 x D.18 cm  
H.38 cm



Item **Burlesque EX04**

L.200 x D.50 cm  
H.100 cm

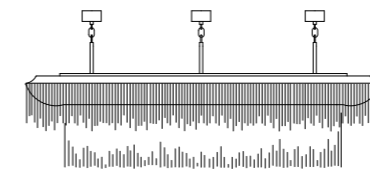

Item **PG268 / 273**

L.70 x D.24 cm  
H.60 cm



## metal finishes



polished white

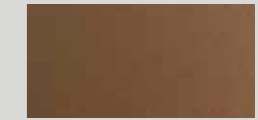

bronze



champagne

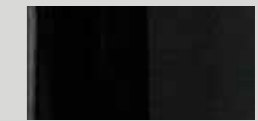

polished black



gold leaf



white & clear



green & clear



red & clear



smoky & clear



amethyst & clear



black & clear

## Crystals

designer PATRIZIA GARGANTI

# Ontherocks

year: 2011

The strings of crystals are exclusively transparent and enriched by irregular elements of different shapes. A coup de theatre of great effect.



► Item **PG007**  
10 lights chandelier

◄ Item **PG027**  
24 lights oval shape  
chandelier



a **coup** de  
*theatre*  
of great  
effect



▲ Item **PG028**  
8 lights ceiling lamp  
Finish: Leaden grey  
Lampshades & accessories: Clear  
crystals

Item **PG031** ▶  
36 lights chandelier  
Finish: Leaden grey  
Lampshades & accessories: Clear  
crystals

◀ Item **PG015**  
18 lights chandelier  
Finish: Leaden grey  
Lampshades & accessories: Clear  
crystals



## Crystal *rain*

Burlesque's sister in style, the Ontherocks lamps are both strong and romantic. The two models share between them that huge amount of crystals that, in a cascade fashion, cover almost entirely the structure, leaving only a glimpse of it to be seen. Kind of see-through. Here, though, the strings of crystals are exclusively transparent and enriched by irregular elements of different shapes – prisms, octagons, multifaceted spheres. A coup de theatre of great effect.

▼ Item **PG010** ▼  
4 lights wall lamp



▼ Item **PG017** ▼  
4 lights wall lamp



▼ Item **PG019**  
2 lights wall lamp



▼ Item **PG024** ▼  
2 lights wall lamp



Item **PG032** ▼  
5 lights wall lamp



Item **PG014** ▼  
5 lights wall lamp



# collection

Item **PG015**  
Ø 120 cm  
H.115 cm min

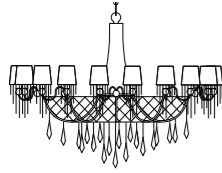

Item **PG016**  
Ø 90 cm  
H.107 cm min

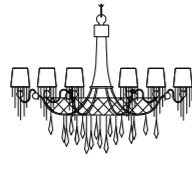

Item **PG014**  
L.70 X D.24 cm  
H.60 cm

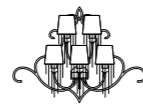

Item **PG023**  
L.46 X D.24 cm  
H.60 cm



Item **PG006**  
Ø 100 cm  
H.140 cm min

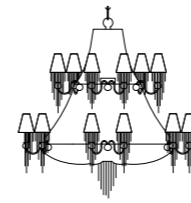

Item **PG007**  
Ø 75 cm  
H.115 cm min

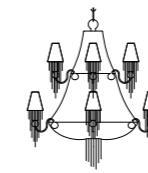

Item **PG009**  
Ø 50 cm  
H.90 cm min

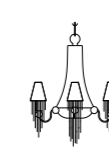

Item **PG033**  
Ø 80 cm  
H.78 cm

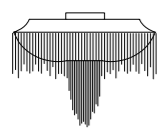

Item **PG034**  
Ø 50 cm  
H.58 cm



Item **PG035**  
Ø 30 cm  
H.51 cm



Item **PG028**  
L.76 x D.55 cm  
H.77 cm

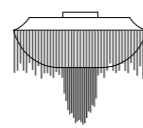

Item **PG029**  
L.62 x D.40 cm  
H.59 cm

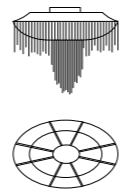

Item **PG001**  
Ø 90 cm  
H.140 cm min

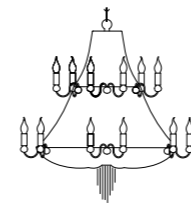

Item **PG002**  
Ø 65 cm  
H.115 cm min

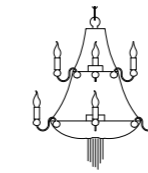

Item **PG004**  
Ø 40 cm  
H.90 cm min

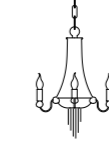

Item **PG032**  
L.50 x D.16 cm  
H.40 cm



Item **PG036**  
Ø 22 cm  
H.54 cm min - 169 max



Item **PG038 / PG039**  
L.31 x D.31 cm  
H.110 cm min



Item **PG037**  
Ø 12 cm  
H.70 cm min - 180 max



Item **PG031**  
Ø 140 cm  
H.158 cm min

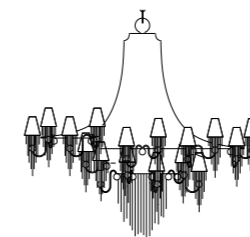

Item **PG030**  
Ø 130 cm  
H.158 cm min

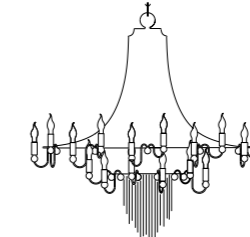

Item **PG010**  
L.58 x D.30 cm  
H.56 cm

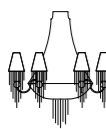

Item **PG024**  
L.45 x D.18 cm  
H.51 cm

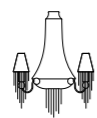

Item **PG005**  
L.56 x D.26 cm  
H.56 cm

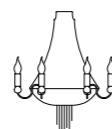

Item **PG025**  
L.40 x D.15 cm  
H.51 cm

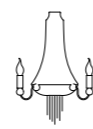

Item **PG017**  
L.33 x D.22 cm  
H.63 cm

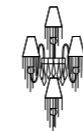

Item **PG018**  
L.32 x D.22 cm  
H.40 cm



Item **PG019**  
L.27 x D.18 cm  
H.38 cm



Item **PG027**  
L.106 x D.82 cm  
H.130 cm min

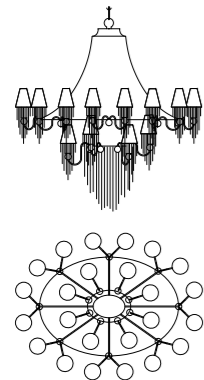

Item **PG026**  
L.96 x D.72 cm  
H.130 cm min

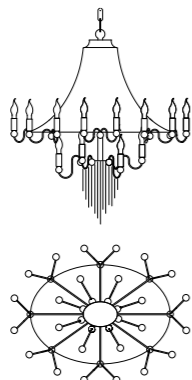

Item **PG008**  
L.93 x D.72 cm  
H.121 cm min

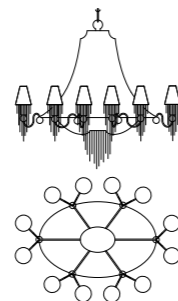

Item **PG003**  
L.83 x D.62 cm  
H.121 cm min

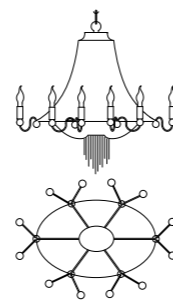

Item **PG011**  
Ø 120 cm  
H.133 cm min

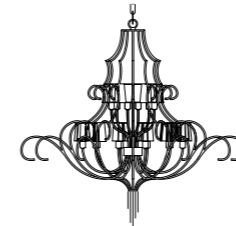

Item **PG020**  
Ø 80 cm  
H.133 cm min

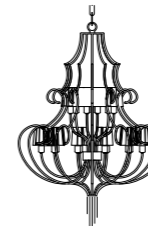

Item **PG012**  
Ø 95 cm  
H.113 cm min

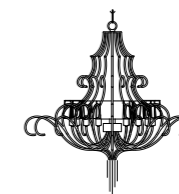

Item **PG021**  
Ø 60cm  
H.113 cm min



Item **PG013**  
Ø 70 cm  
H.101 cm min

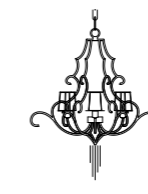

Item **PG022**  
Ø 46 cm  
H.101 cm min



leaden grey



clear crystals

metal finishes

accessories

designer PATRIZIA GARGANTI

## Moulin Rouge

year: 2011

The metallic structure is wrapped with a continuous line of irregular pearls, singularly inserted by expert hands.



- ▲ Item **Moulin Rouge EX20**  
39 lights chandelier  
Finish: Polished black & gunmetal details  
Accessories: Black crystals
- ◀ Item **Moulin Rouge EX19**  
39 lights chandelier  
Finish: Gold plated  
Accessories: Amethyst & clear crystals

# Sparkle of a *newfound* time

The inspiration behind Moulin Rouge almost happened by chance, with an unexpected finding in a dusty attic, this ignited the will to recreate a lamp that could recall old styles but that could also be dressed in a new, shiny cover. The metallic structure is wrapped with a continuous line of irregular pearls, singularly inserted by expert hands and enriched with some crystal nuggets handmade in Murano.



▲ Item **Moulin Rouge EX15**  
1 light table lamp  
Finish: Silver leaf & silver plated details  
Lampshade: T16 cat.C  
Accessories: Clear crystal pearls



▲ Item **Moulin Rouge EX12**  
1 light table lamp  
Finish: M19 & silver plated details  
Lampshade: T16 cat.C  
Accessories: Clear crystal pearls



▲ Item **Moulin Rouge EX14**  
1 light table lamp  
Finish: Gold leaf & gold plated details  
Lampshade: Green silk  
Accessories: Clear crystal pearls



▲ Item **Moulin Rouge EX11**  
1 light wall lamp  
Finish: Silver leaf & silver plated details  
Lampshade: T16 cat.C  
Accessories: Clear crystal pearls



Item **Moulin Rouge EX10** ▲  
1 light wall lamp  
Finish: Gold leaf & gold plated details  
Lampshade: Dove grey organza  
Accessories: Clear crystal pearls



Item **Moulin Rouge EX23** ▲  
6 lights wall lamp  
Finish: Gold plated  
Accessories: Clear crystal nuggets & pearls



Item **PG328** ▲  
39 lights chandelier  
Finish: Polished silver leaf  
Accessories: Clear crystal nuggets & pearls



▲ Item **Moulin Rouge EX17**  
6 lights floor lamp  
Finish: M19 & silver plated details  
Lampshade: T16 cat.C  
Accessories: Clear crystal pearls





▲ Item **Moulin Rouge EX07**  
 28 lights chandelier  
 Finish: M19 & silver plated details  
 Lampshades: T16 cat.C  
 Accessories: Clear crystal nuggets & pearls



▲ Item **Moulin Rouge EX09**  
 36 lights chandelier  
 Finish: Gold plated  
 Accessories: Clear crystal nuggets & pearls

...the will to recreate  
 a lamp that could  
**recall old styles**  
 but that could also be  
***dressed in a new,  
 shiny cover***



◀ Item **Moulin Rouge EX22**  
 74 lights chandelier  
 Finish: Gold leaf & gold plated details  
 Accessories: Clear crystal nuggets & pearls



▲ Item **Moulin Rouge EX05**  
 8 lights wall lamp  
 Finish: Gold plated  
 Accessories: Clear crystal nuggets & pearls



◀ Item **Moulin Rouge EX16**  
 3 lights floor lamp  
 Finish: Gold leaf & gold plated details  
 Lampshade: Green silk  
 Accessories: Clear crystal pearls

# collection

Item **Moulin Rouge EX13**  
Ø 44 cm  
H.190 cm

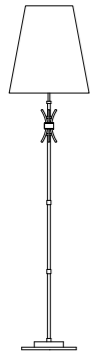

Item **Moulin Rouge EX16**  
Ø 42 cm  
H.174 cm

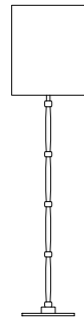

Item **Moulin Rouge EX17**  
Ø 54 cm  
H.179 cm

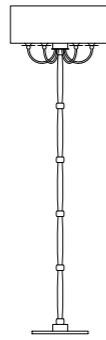

Item **Moulin Rouge EX18**  
Ø 76 cm  
H.196 cm

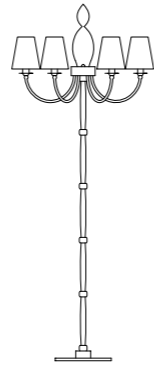

Item **Moulin Rouge EX08**  
Ø 64 cm  
H.420 cm min

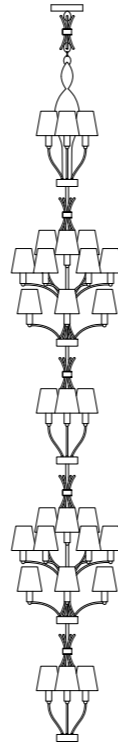

Item **Moulin Rouge EX09**  
Ø 62 cm  
H.380 cm min



Item **Moulin Rouge EX22**  
L.200 x D.200 cm  
H.210 cm

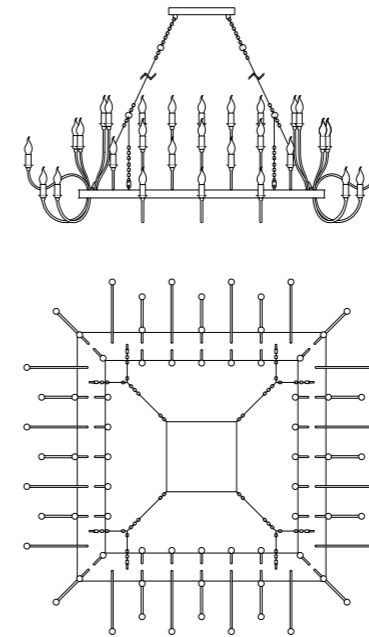

Item **Moulin Rouge EX02 / EX03 / EX05**  
L.52 x D.27 cm  
H.110 cm

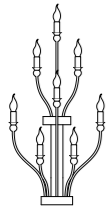

Item **Moulin Rouge EX23**  
L.40 x D.20 cm  
H.59 cm

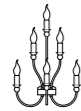

Item **Moulin Rouge EX24**  
L.28 x D.20 cm  
H.65 cm



Item **PG331, Moulin Rouge EX33 / EX34 / EX35**  
L.43 x D.19 cm  
H.44 cm



Item **PG343/345, PG346/348 Moulin Rouge EX29**  
L.43 x D.22 cm  
H.44 cm (54 cm for items with crystal lampshades)



Item **Moulin Rouge EX11**  
L.15 x D.23 cm  
H.70 cm

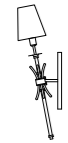

Item **Moulin Rouge EX10**  
L.15 x D.20 cm  
H.60 cm

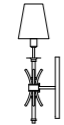

Item **Moulin Rouge EX14**  
Ø 26 cm  
H.77 cm

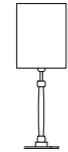

Item **Moulin Rouge EX12**  
Ø 34 cm  
H.95 cm



Item **Moulin Rouge EX15**  
Ø 34 cm  
H.107 cm

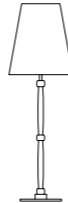

Item **PG315/316, PG326/327, PG338/339**  
Ø 12 cm  
H.77 cm min - 187 max



Item **PG340/342**  
Ø 31 cm  
H.110 cm



Item **Moulin Rouge EX21**  
L.250 x D.64 cm  
H.150 cm

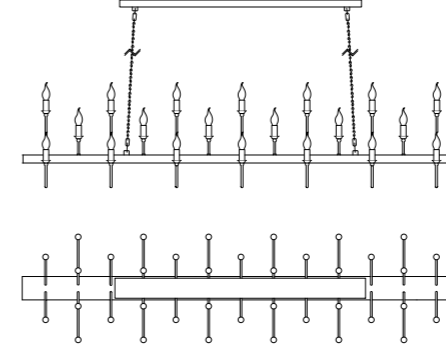

Item **PG329, PG309/311, PG320/322**  
Ø 95 cm  
H.95 cm min (105 cm for items with crystal lampshades)

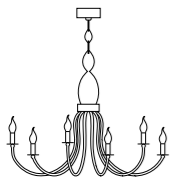

Item **PG330, PG312/314, PG323/325 Moulin Rouge EX31**  
Ø 70 cm  
H.85 cm min (95 cm for items with crystal lampshades)

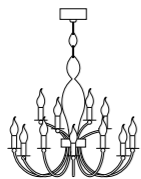

Item **PG332 / 334**  
Ø 118 cm  
H.84 cm min



Item **Moulin Rouge EX30**  
Ø 120 cm  
H.100 cm min

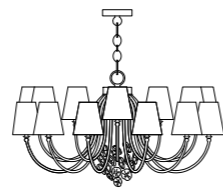

Item **PG335 / 337**  
Ø 95 cm  
H.89 cm min



Item **PG328, PG306/308, PG317/319 Moulin Rouge EX01 / EX06 / EX04 / EX19 / EX20 / EX32**  
Ø 100 cm  
H.150 cm min (160 cm for items with crystal lampshades)

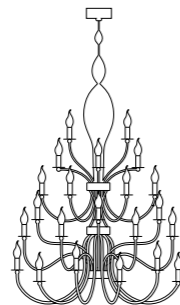

Item **Moulin Rouge EX25**  
Ø 120 cm  
H.150 cm min

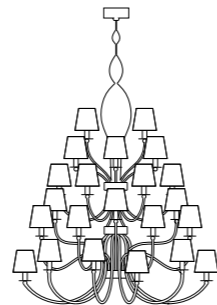

Item **Moulin Rouge EX28**  
Ø 90 cm  
H.100 cm min

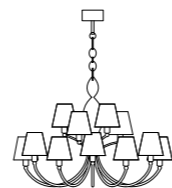

Item **Moulin Rouge EX27**  
Ø 140 cm  
H.100 cm min

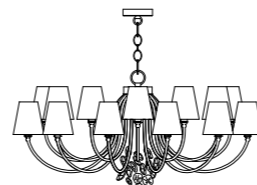

Item **Moulin Rouge EX07**  
L.215 x D.72 cm  
H.150 cm

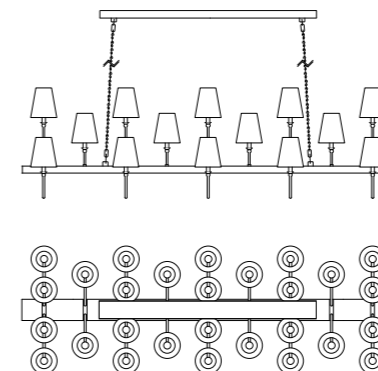

## metal finishes



gold plated

polished nickel

silver plated



M20 & gold plated details

gold leaf & gold plated details

polished silver leaf / polished silver leaf & silver plated details



M19 & silver plated details

M05 & gunmetal details

M22 & silver plated details



polished black / polished black & gunmetal details

## crystals



clear crystals & blown glass daisies



clear crystal chains



smoky & black crystal chains



black crystal chains



clear crystals



clear crystal nuggets & pearls



black & smoky crystals



black crystals



amethyst & clear crystals

## fabrics



goffered silk T18 cat.C



goffered silk T24 cat.C



T16 cat.C



dove grey organza



T03+T02 cat.A organza



T13 cat.C (grey side)



green silk

designer PATRIZIA GARGANTI

1180

year: 2015

A crystal web envelops the structure  
in a sensual embrace.

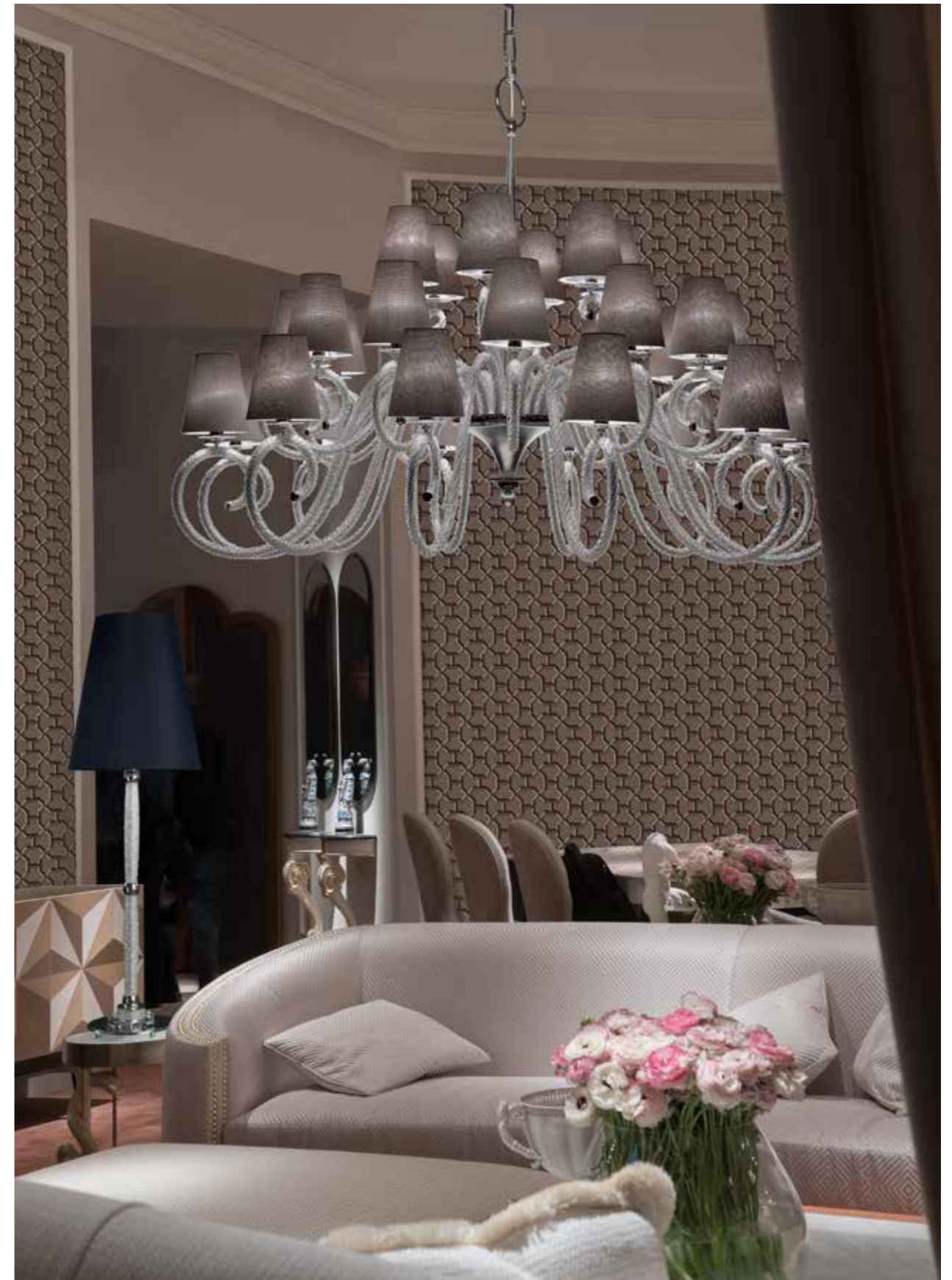

◀ Item **1180 EX02**  
30 lights chandelier  
Finish: M20 & gold plated details  
Accessories: Smoky crystals  
Lampshades: Dove grey organza

Item **1180 EX03** ▲  
30 lights chandelier  
Finish: Silver leaf &  
gunmetal details  
Accessories: Clear crystals  
Lampshades: Dove grey organza



## Sensual *embrace*

A crystal web envelops the structure  
in a sensual embrace.  
A richly suggestive and aware world  
where the crystals model the surface.



Item **1184 EX02**  
20 lights chandelier  
Finish: M20 & gold plated details  
Accessories: Smoky crystals  
Lampshades: Dove grey organza



Item **1185 EX01**  
6 lights wall lamp  
Finish: M20 & silver plated details  
Accessories: Smoky crystals  
Lampshades: Dove grey organza

## collection

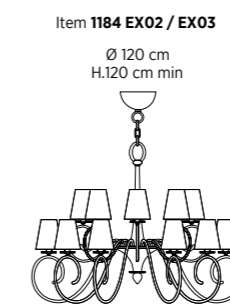
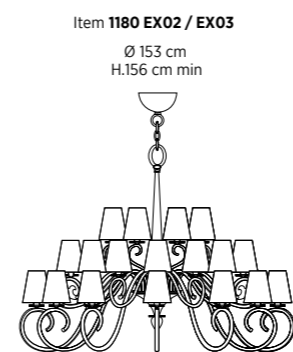

### accessories



smoky crystals



clear crystals

### lampshades



dove gray organza

### metal finishes



silver leaf & gunmetal  
details



M20 & gold plated  
details



M20 & gold plated  
details

designer PATRIZIA GARGANTI

# Ginger&Fred

year: 2011

Ginger & Fred is a rhythm: of shadows, of reflections,  
of luminous vibrations.



◀ Item **PG542, PG527**  
1 light table lamp  
Ceramic finish: Platinum  
& chrome  
Lampshade: Ivory  
cotton ribbon



◀ Item **PG529, PG534**  
1 light table lamp  
Ceramic finish: White &  
chrome  
Lampshade: Grey &  
black cotton ribbon &  
ivory leather ribbon



◀ Item **PG540, PG525**  
1 light table lamp  
Ceramic finish: Black &  
chrome  
Lampshade: Ivory  
cotton ribbon

◀ Item **PG538, PG533**  
1 light table lamp

# Dance for two

## collection

Item PG529/533  
Ø 52 cm  
H.128 cm



Item PG534/538  
Ø 35 cm  
H.90 cm



Item PG524/528  
Ø 52 cm  
H.128 cm



Item PG539/543  
Ø 35 cm  
H.90 cm



Item PG564/568  
Ø 18 cm  
H.50 cm min  
150 cm max



Item PG569/573  
Ø 12 cm  
H.44 cm min  
144 cm max



Item PG512/514  
PG582/583  
L.40 X D.40 cm  
H.195 cm



Item PG500/502  
PG574/575  
L.40 X D.40cm  
H.145 cm

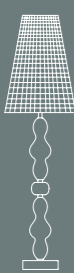

Item PG544/548  
L.23 X D.23 cm  
H.59 cm



Item PG515/517  
PG584/585  
Ø 60 cm  
H.160 cm



Item PG503/505  
PG576/577  
Ø 60 cm  
H.110 cm

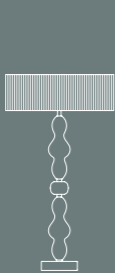

Item PG549/553  
Ø 30 cm  
H.45 cm



Item PG518/520  
PG586/587  
Ø 52 cm  
H.202cm



Item PG506/508  
PG578/579  
Ø 52 cm  
H.152 cm

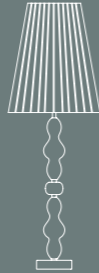

Item PG554/558  
Ø 25 cm  
H.59 cm



Item PG521/523  
PG588/589  
Ø 52 cm  
H.202 cm



Item PG509/511  
PG580/581  
Ø 52 cm  
H.152 cm

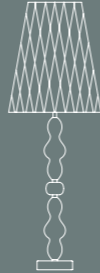

Item PG559/563  
Ø 25 cm  
H.59 cm



Item PG585  
1 light floor lamp  
Ceramic finish:  
Copper & chrome  
Lampshade: Grey  
& hazel cotton  
ribbon



Item PG577  
1 light  
table lamp



Item PG574, PG582  
1 light table lamp &  
1 light floor lamp  
Ceramic finish:  
Platinum & chrome  
Lampshade: Grey cotton  
& ivory leather ribbon

Item PG507, PG519  
1 light table lamp &  
1 light floor lamp  
Ceramic finish:  
Black & chrome  
Lampshade: Grey &  
black cotton ribbon &  
ivory leather ribbon

Item PG509, PG521  
1 light table lamp &  
1 light floor lamp  
Ceramic finish:  
White & chrome  
Lampshade: Ivory  
cotton ribbon



Item PG564  
1 light suspension lamp  
Ceramic finish: White & chrome  
Accessories: Brown leather cable

A simple and sophisticated coreography. Dancing, even in its formal essentiality. Ginger & Fred is a family made of standing lamps, table lamps and suspension lamps. Created in ceramic, an artisanal production which highlights a great artistry, that is synonymous with Made in Italy. Ginger & Fred is a rhythm: of shadows, of reflections, of luminous vibrations.

### lampshades



ivory cotton ribbon



grey & hazel cotton ribbon

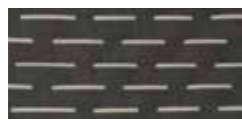

grey cotton & ivory leather ribbon



grey & black cotton ribbon & ivory leather ribbon

### ceramic finishes



white & chrome

black & chrome

orange & chrome

platinum & chrome

copper & chrome

designer PATRIZIA GARGANTI

## Nana

year. 2011

Clear crystal spheres located in a natural and random way that amplify the reflections, like light grapes



◀ Item **PG411**  
12 lights chandelier  
Finish: Polished nickel  
Lampshades: Ivory eco leather  
Accessories: Clear crystal grapes



Item **PG450** ▶  
1 light table lamp  
Finish: Gold plated  
Lampshade &  
accessories: Clear crystal  
pearls



◀ Item **PG452**  
1 light table lamp  
Finish: Polished nickel  
Lampshade &  
accessories: Clear crystal  
pearls



▲ Item **PG453**  
1 light table lamp



Item **PG434** ▶  
19 lights chandelier  
Finish: Polished nickel  
Lampshades & accessories :  
Clear crystal nuggets and pearls



## collection

Item **PG400 - 406/410**  
Ø 120 cm  
H.102 cm min

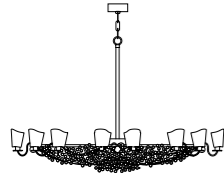

Item **PG401 - 411/415**  
Ø 105 cm  
H.102 cm min

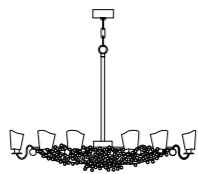

Item **PG402 - 416/420**  
Ø 82 cm  
H.91 cm min

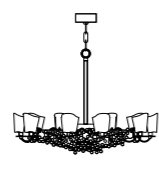

Item **PG424/425**  
Ø 120 cm  
H.102 cm min

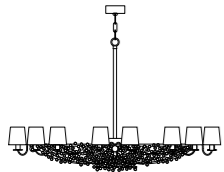

Item **PG426/427**  
Ø 105 cm  
H.102 cm min

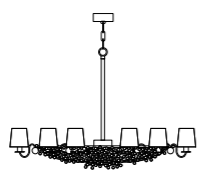

Item **PG428/429**  
Ø 82 cm  
H.91 cm min

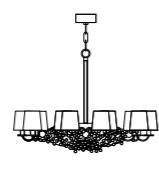

Item **PG434/435**  
Ø 120 cm  
H.102 cm min

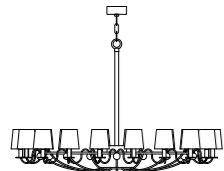

Item **PG436/437**  
Ø 105 cm  
H.102 cm min

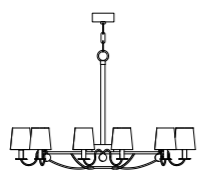

Item **PG438/439**  
Ø 82 cm  
H.91 cm min

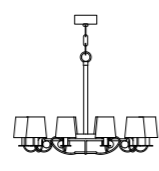

Item **PG403  
PG421**  
Ø 80 cm  
H.28 cm



Item **PG404  
PG422**  
Ø 50 cm  
H.23 cm



Item **PG405  
PG423**  
Ø 30 cm  
H.17 cm



Item **PG430  
PG431**  
L.51 X D.29 cm  
H.23 cm



Item **PG432  
PG433**  
L.32 X D.19 cm  
H.15 cm



Item **PG450/453**  
Ø 18 cm  
H.53 cm



Item **PG440  
PG441**  
Ø 80 cm  
H.28 cm



Item **PG442  
PG443**  
Ø 50 cm  
H.23 cm

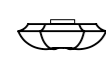

Item **PG444  
PG445**  
Ø 30 cm  
H.17 cm



Item **PG446  
PG447**  
L.51 X D.29 cm  
H.19 cm



Item **PG448  
PG449**  
L.32 X D.19 cm  
H.15 cm



Item **Nana EX01**  
Ø 15 cm  
H.5 cm



## metal finishes



polished nickel



gold plated

## lampshades

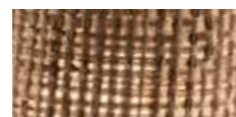

coconut fiber



clear crystal pearls



ivory eco leather



black eco leather

## accessories



clear crystal grapes



clear crystal nuggets & pearls

# Magical berries

Nana has multiple versions... different forms and different coating techniques: a first one with a single string of transparent pearls that revolves around the metallic part and the lampshades as well; a second one decorated with magical berries: clear crystal spheres located in a natural and random way that amplify the reflections, like light grapes.

▲ Item **PG432**  
1 light wall lamp



Item **PG418** ▶  
10 lights chandelier  
Finish: Gold plated  
Lampshades:  
Coconut fiber  
Accessories:  
Clear crystal grapes



designer PATRIZIA GARGANTI

# Morgana

year: 2013

Power and grace, together



► Item **7201 Custom**  
21 lights chandelier  
Finish: Gold plated  
Lampshades: T22 cat.C  
Accessories: Clear  
crystal nuggets

◀ Item **Morgana EX12  
Custom**  
33 lights chandelier





# A fairy and her knights



◀ Item **Morgana EX05**  
76 lights chandelier  
Finish: Gold leaf & gold plated details  
Accessories: Clear crystal nuggets



◀ Item **Morgana EX07\_S**  
1 light floor lamp  
Finish: Silver leaf & silver plated details  
Accessories: Clear crystal nuggets  
Lampshade: Organza T03+T02 cat. A



Item **Morgana Ex06** ▶  
14 lights wall lamp  
Finish: Silver leaf & silver plated details  
Accessories: Clear crystal nuggets  
Lampshades: Organza T03+T02 cat. A



◀ Item **7202**  
21 lights chandelier  
Finish: Gunmetal  
Accessories: Clear crystal nuggets



◀ Item **7214**  
5 lights wall lamp

This model is a chandelier full of personality and attitude. The main feature is the thin but solid metallic structure characterised by curves that chase each other like a needlework, enhanced by handmade Murano crystal nuggets. Power and grace, together.



# collection

metal finishes



gunmetal



gold plated



silver leaf & silver plated details



gold leaf & gold plated details



T24 cat.C



T03+T02 cat.A organza



goffered organza T02



T21 cat.C



black eco leather

accessories

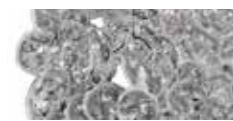

clear crystal nuggets

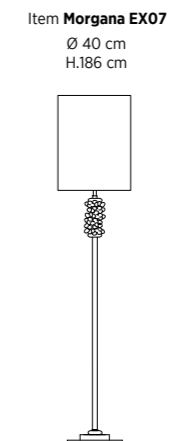
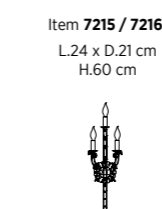
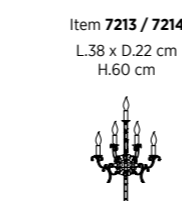
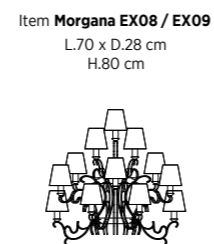
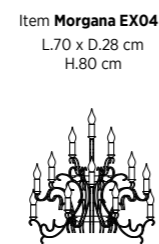
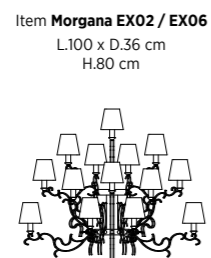
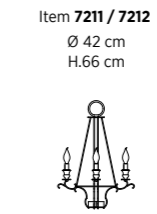
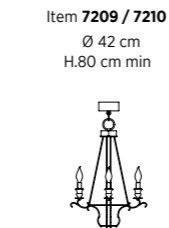
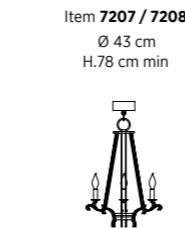
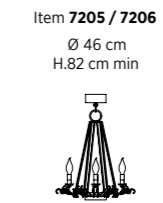
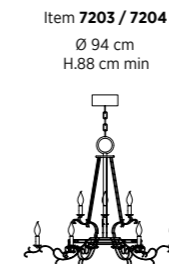
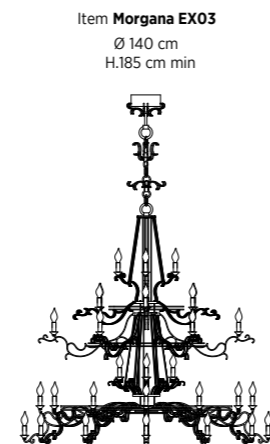
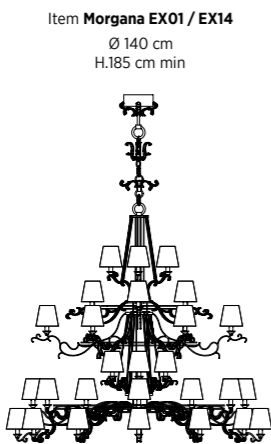
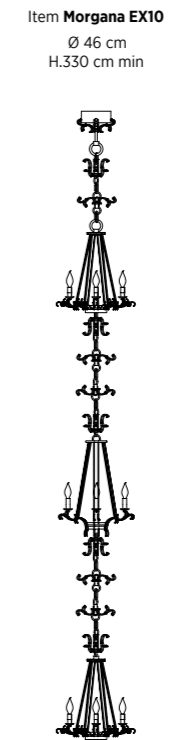
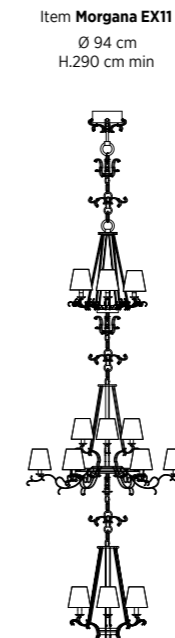
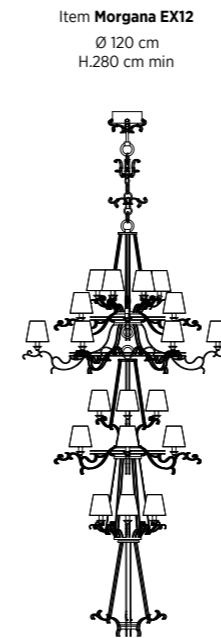
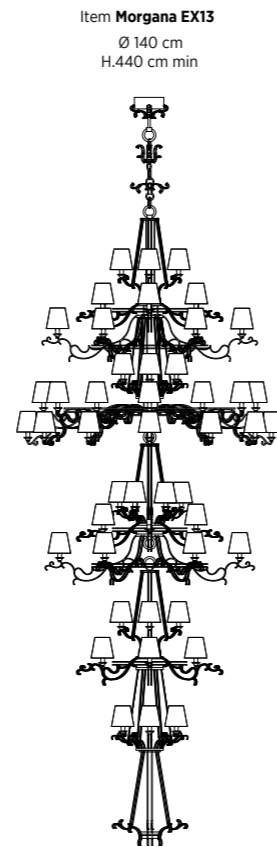
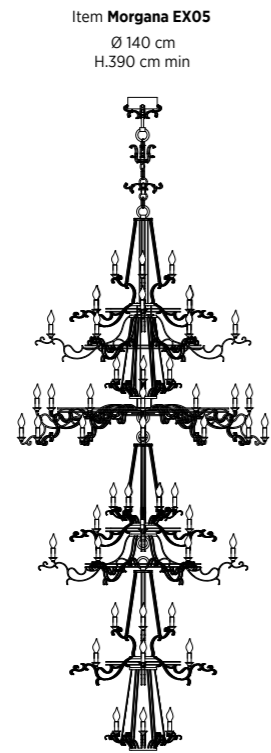

▲ Item **Morgana EX10**  
15 lights chandelier



▲ Item **Morgana EX15**  
72 lights chandelier  
Finish: Gunmetal & copper details  
Accessories: Clear crystals

# collection

metal finishes

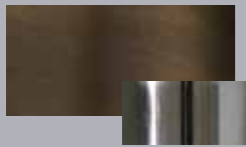

burnished brass & polished nickel details



gunmetal & copper details

accessories



clear crystals

Item **Morgana EX15**  
Ø 193 cm  
H.155 cm min

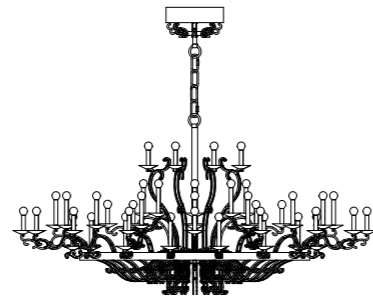

Item **Morgana EX16**  
Ø 100 cm  
H.110 cm min

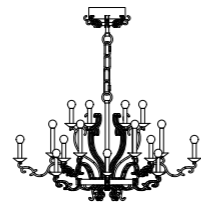

Item **Morgana EX17**  
Ø 75 cm  
H.85 cm min

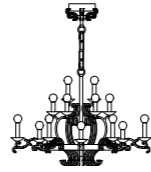

Item **Morgana EX18**  
L.60 x D.30 cm  
H.55 cm

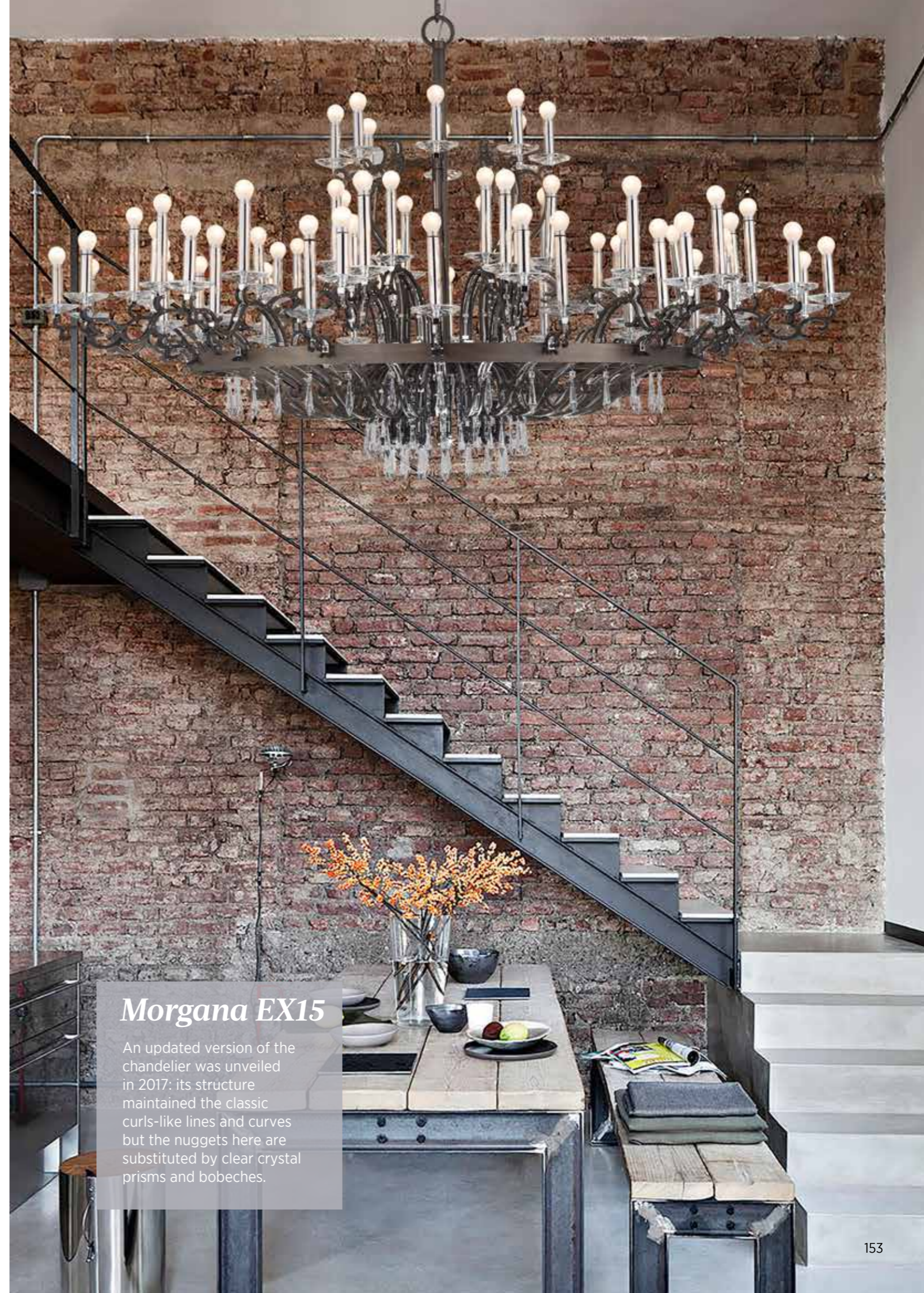
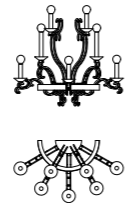

## *Morgana EX15*

An updated version of the chandelier was unveiled in 2017: its structure maintained the classic curls-like lines and curves but the nuggets here are substituted by clear crystal prisms and bobeches.

designer PATRIZIA GARGANTI

## Ophelia

year: 2005

Looking upwards it seems like  
there are strawberry fields  
on the ceiling!



▲ Item **Ophelia EX08**  
12 lights chandelier  
Finish: Leaden & polished nickel details  
Lampshades: T18 cat.C  
Accessories: Clear crystals

◀ Item **Ophelia EX06**  
24 lights chandelier  
Finish: Burnished brass & polished nickel details  
Accessories & lampshades: Clear crystals

# Strawberry fields

Looking upwards it seems like there are strawberry fields on the ceiling! Ophelia, which has been the company's symbol for years, has evolved into different models of itself. In the last model the strawberries have been substituted by prisms in clear crystal, while lampshades created with crystal lozenges have made their way in favor of the traditional fabric ones.



▲ **Item 7037**  
12 lights chandelier  
Finish: Silver leaf  
Lampshades: Blue silk  
Accessories: Clear crystals

◀ **Item 7085**  
3 lights wall lamp  
Finish: Silver leaf  
Lampshades: Blue silk  
Accessories: Clear crystals



▲ **Item 7035**  
18 lights chandelier  
Finish: Gold leaf  
Lampshades: Ivory silk  
Accessories: Clear & amber crystals

◀ **Item Ophelia EX04**  
24 lights ceiling lamp  
Finish: Gold leaf  
Accessories: Clear & amber crystals

▼ **Item 7055**  
6 lights ceiling lamp  
Finish: Gold leaf  
Accessories: Clear & amber crystals







▲ Item **Ophelia EX02 custom**  
54 lights chandelier  
Finish: Gold leaf & gold plated details  
Lampshades: T07 cat.B  
Accessories: Clear crystals

Item **7006** ▶  
24 lights chandelier  
Finish: Gold leaf  
Lampshades: Brown silk  
Accessories: Clear crystals



# collection

Item **Ophelia EX02**  
 Ø 200 cm  
 H.300 cm min

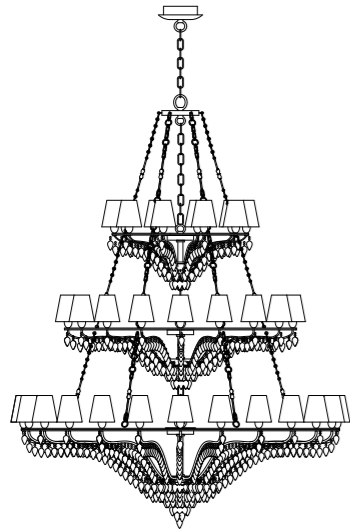

Item **Ophelia EX01**  
 Ø 146 cm  
 H.280 cm min

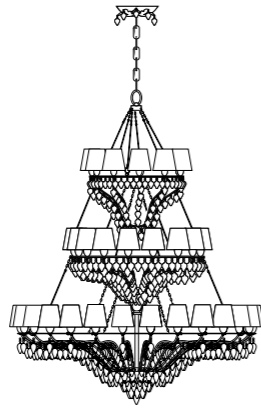

Item **Ophelia EX05, 7012 - 7023**  
 Ø 132 cm  
 H.140 cm min

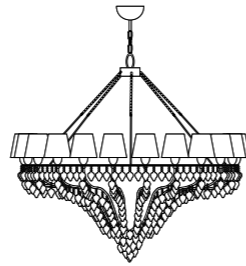

Item **Ophelia EX06**  
 Ø 150 cm  
 H.124 cm min

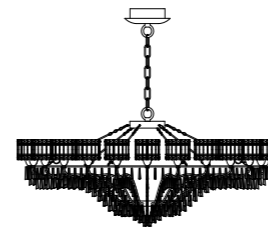

Item **Ophelia EX07**  
 Ø 146 cm  
 H.124 cm min

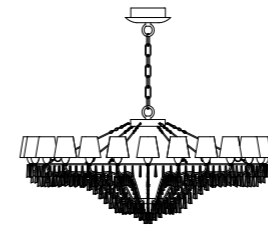

Item **7000 - 7011**  
 Ø 146 cm  
 H.80 cm min

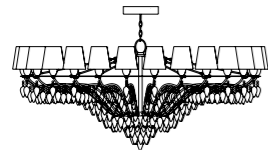

Item **7024 - 7035**  
 Ø 93 cm  
 H.113 cm min

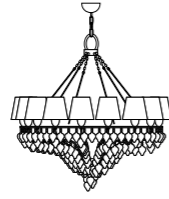

Item **7036 - 7047**  
 Ø 66 cm  
 H.110 cm min

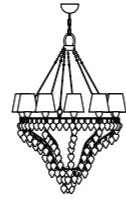

Item **Ophelia EX04**  
 Ø 160 cm  
 H.62 cm



Item **7048 - 7051**  
 Ø 86 cm  
 H.40 cm



Item **7052 - 7055**  
 Ø 60 cm  
 H.47 cm



Item **7056 - 7059**  
 Ø 47 cm  
 H.33 cm



Item **Ophelia EX09**  
 Ø 97 cm  
 H.113 cm min

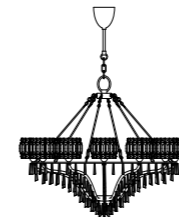

Item **Ophelia EX08**  
 Ø 65 cm  
 H.120 cm min

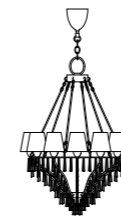

Item **Ophelia EX03**  
 Ø 52 cm  
 H.100 cm

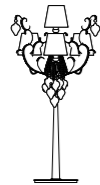

Item **7060 - 7071**  
 L.90 x D.46 cm  
 H.50 cm

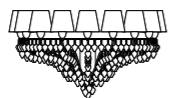

Item **7072 - 7083**  
 L.64 x D.32 cm  
 H.50 cm

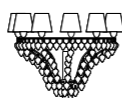

Item **7084 - 7095**  
 L.47 x D.28 cm  
 H.47 cm



silver leaf

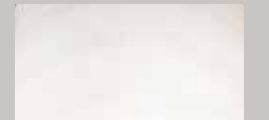

white organza



gold leaf



dove grey organza



silver leaf & silver plated details



brown silk



gold leaf & gold plated details

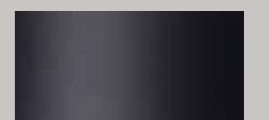

black fabric



gold plated



clear crystals

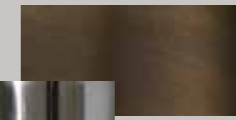

burnished brass & polished nickel details



clear crystals



leaden & polished nickel details



clear & amber crystals



clear crystals



clear & black crystals

metal finishes

lampshades

accessories

designer PATRIZIA GARGANTI

# Margherita

year: 2013

A beauty that is simple and sophisticated  
at the same time, capable of amplifying the precious  
reflections of the crystal.

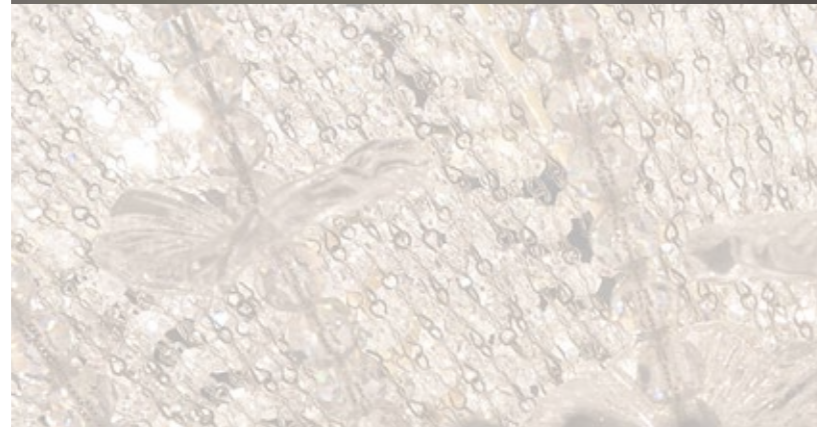

▲ Item **Margherita EX01**  
32 lights chandelier  
Finish: Silver leaf & silver  
plated details  
Accessories:  
clear crystals  
& blown glass daisies

◀ Item **7401**  
19 lights chandelier



◀ Item **Margherita EX06**  
32 lights  
chandelier  
Finish: Bronze & gold  
plated details  
Accessories: clear  
crystals & blown glass  
daisies



◀ Item **Margherita EX07**  
16 lights ceiling lamp  
Finish: Gold leaf & gold  
plated details  
Accessories: clear crystals  
& blown glass daisies

## a petal *leads* to another

A flowery bouquet. A traditional metallic structure hosts a string of transparent pearls enriched with daisies in Murano's blown glass: handmade, they maintain the naturality given by their uniqueness, just like flowers.

## lampshades accessories



T02 cat.A organza



clear crystals &  
blown glass daisies

## metal finishes



satin nickel



silver plated



gold plated



bronze & gold plated  
details



gold leaf & gold plated  
details



silver leaf & silver plated  
details

## collection

Item **Margherita EX02**  
Ø 146 cm  
H.290 cm min

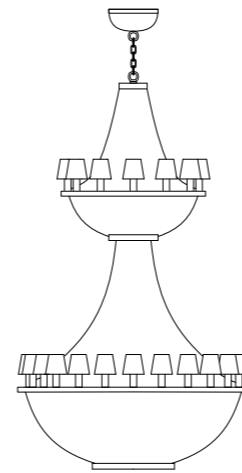

Item **Margherita EX01**  
Ø 140 cm  
H.230 cm min

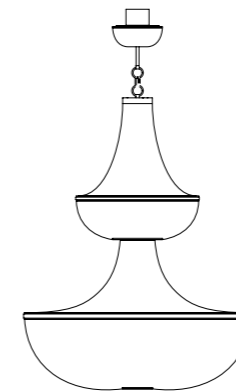

Item **Margherita EX06**  
L.90 x D.90 cm  
H.160 cm

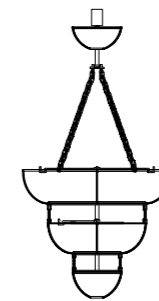

Item **Margherita EX03**  
Ø 85 cm  
H.140 cm min

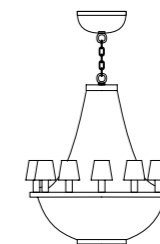

Item **7401 - 7403**  
Ø 80 cm  
H.145 cm min

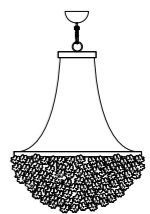

Item **7404 - 7406**  
Ø 42 cm  
H.88 cm min



Item **7407 - 7409**  
Ø 30 cm  
H.76 cm min



Item **Margherita EX07**  
L.140 x D.70 cm  
H.110 cm

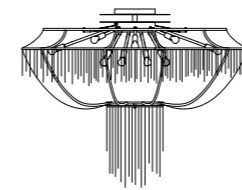

Item **7410 - 7412**  
Ø 80 cm  
H.40 cm

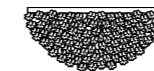

Item **7413 - 7415**  
Ø 46 cm  
H.27 cm



Item **7416 - 7418**  
Ø 30 cm  
H.21 cm



Item **Margherita EX04**  
Ø 80 cm  
H.30 cm

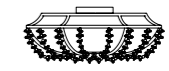

Item **Margherita EX05**  
L.51 x D.29 cm  
H.19 cm



Item **7425 - 7427**  
L.31 x D.31 cm  
H.100 cm



Item **7428 - 7430**  
Ø 12 cm  
H.62 cm min - 172 cm max



Item **7419 - 7421**  
L.42 x D.21 cm  
H.60 cm



Item **7422 - 7424**  
L.30 x D.15 cm  
H.51 cm





designer PATRIZIA GARCANTI

## Eva

year: 2013

It's the attention to details  
that makes the difference.



◀ Item 7605 custom  
19 lights chandelier  
Finish: Silver plated  
Accessories: Smoky  
& clear crystal chains

▲ Item 7602  
18 lights chandelier  
Finish: Silver plated  
Accessories: Clear crystal chains



satin nickel



silver plated

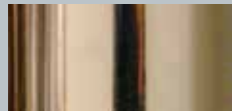

gold plated



silver leaf



gold leaf



clear crystal chains



smoky & black crystal chains



smoky & clear crystal chains



amethyst crystal chains

# collection

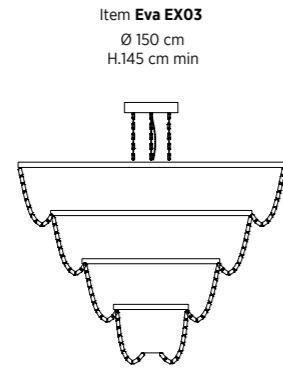

Item Eva EX03  
Ø 150 cm  
H.145 cm min

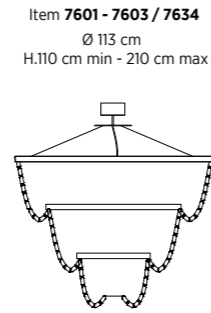

Item 7601 - 7603 / 7634  
Ø 113 cm  
H.110 cm min - 210 cm max



Item 7628 - 7630  
L.31 x D.31 cm  
H.108 cm min

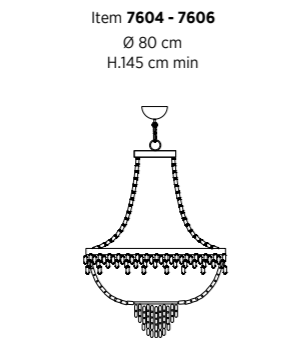

Item 7604 - 7606  
Ø 80 cm  
H.145 cm min

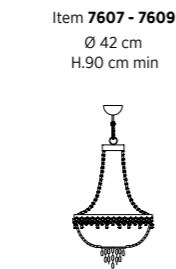

Item 7607 - 7609  
Ø 42 cm  
H.90 cm min



Item 7610 - 7612  
Ø 30 cm  
H.76 cm min



Item Eva EX01,  
7613 - 7615  
Ø 80 cm  
H.74 cm



Item 7616 - 7618  
Ø 46 cm  
H.28 cm



Item 7619 - 7621  
Ø 30 cm  
H.30 cm

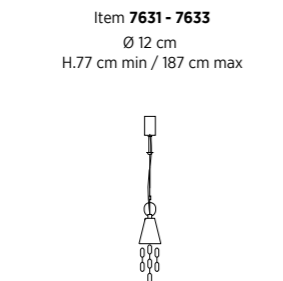

Item 7631 - 7633  
Ø 12 cm  
H.77 cm min / 187 cm max

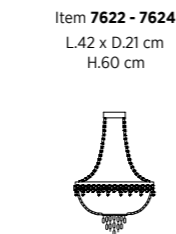

Item 7622 - 7624  
L.42 x D.21 cm  
H.60 cm



Item 7625 - 7627  
L.30 x D.15 cm  
H.51 cm



Item 7633 ▶  
1 light suspension lamp  
Finish: Nickel  
Accessories: Clear crystal chains



◀ Item 7609  
5 lights chandelier  
Finish: Satin nickel  
Accessories: Clear crystal chains



▲ Item 7627  
2 lights wall lamp  
Finish: Satin nickel  
Accessories: Clear crystal chains

◀ Item 7615  
9 lights ceiling lamp  
Finish: Satin nickel  
Accessories: Clear crystal chains

a *chain*  
is forever

A smooth cascade of crystal chains wraps Eva and its metallic structure, over which expert artisan hands weave textures, patiently sticking every ring, pearl by pearl: It's the attention to details that makes the difference.

# Sinuosa

year: 2009

A lamp which joins a retro style with the all-feminine habit of tout-court decoration



▲ Item **Sinuosa EX07**  
12 lights chandelier  
Finish: Polished nickel  
Lampshades: T22 cat.C  
Accessories: White nickel  
Chain 2

▲ Item **Sinuosa EX05**  
12 lights chandelier  
Finish: Polished nickel  
Lampshades: T19 cat.C  
Accessories: White nickel  
Chain 2

Item **Sinuosa EX11** ▶  
 18 lights chandelier  
 Finish: Polished nickel  
 Lampshades & Accessories:  
 Clear crystals



Item **Sinuosa EX16** ▶  
 2 lights wall lamp  
 Finish: Polished nickel  
 Lampshades: Ivory silk cat.C  
 Accessories: Clear crystals



A vibrating structure that sustains a **carousel** of delicate lampshades.



▲ Item **Sinuosa EX13** - 5 lights chandelier  
 Finish: Polished nickel  
 Lampshades & accessories: Clear crystals



▲ Item **Sinuosa EX14** - 5 lights chandelier  
 Finish: Polished nickel  
 Lampshades: Ivory silk cat.C  
 Accessories: Clear crystals



▲ Item **Sinuosa EX15** - 2 lights wall lamp  
 Finish: Polished nickel  
 Lampshades & accessories: Clear crystals





Item **Sinuosa EX01**  
 Ø 172 cm  
 H. 230 cm min

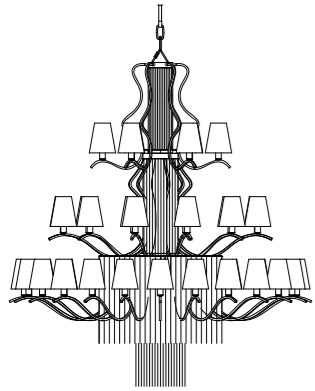

Item **Sinuosa EX04**  
 Ø 130 cm  
 H. 200 cm min

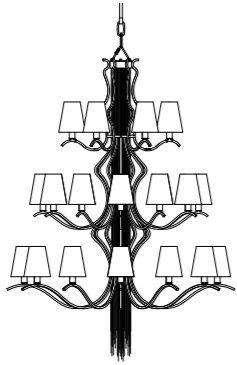

Item **Sinuosa EX02**  
 L.125 x D.62 cm  
 H.170 cm

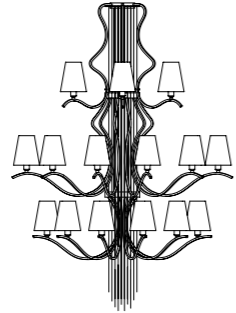

Item **Sinuosa EX03**  
 Ø 130 cm  
 H. 160 cm min



Item **SN04** ▶  
 5 lights chandelier  
 Finish: M23  
 Lampshades: T12 cat.C  
 Accessories: Gold & natural brass  
 Chain 2



Item **Sinuosa EX06 / EX10**  
 Ø 102 cm  
 H. 118 cm min

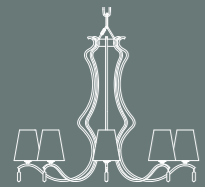

Item **Sinuosa EX05**  
 Ø 130 cm  
 H. 128 cm min

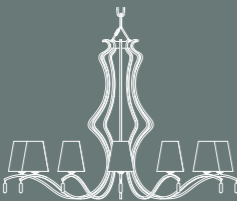

Item **SN02**  
 Ø 102 cm  
 H. 138 cm min



Item **Sinuosa EX09, SN01**  
 Ø 130 cm  
 H. 148 cm min



Item **Sinuosa EX08**  
 Ø 102 cm  
 H. 60 cm min



Item **Sinuosa EX07**  
 Ø 130 cm  
 H. 62 cm min



Item **SN06**  
 L.62 x D.32 cm  
 H.73 cm



Item **SN07**  
 L.62 x D.32 cm  
 H.73 cm



## Light tentacles

A series of metallic bending ramifications that unravel in space, starting from a branching point. A vibrating structure that sustains a carousel of delicate lampshades. A lamp which joins a retro style with the all-feminine habit of tout-court decoration.

Item **Sinuosa EX11**  
 Ø 130 cm  
 H. 95 cm min

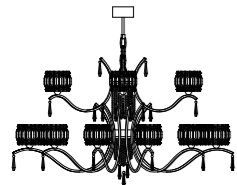

Item **Sinuosa EX13**  
 Ø 63 cm  
 H. 100 cm min

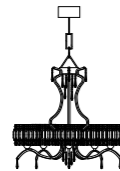

Item **Sinuosa EX14**  
 Ø 63 cm  
 H. 100 cm min

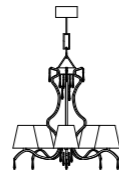

Item **Sinuosa EX12**  
 Ø 130 cm  
 H. 95 cm min

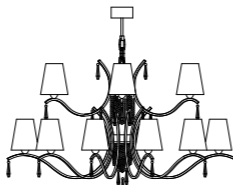

◀ Item **Sinuosa EX03**  
 18 lights chandelier  
 Finish: Leaden grey  
 Lampshades: T22 cat.C  
 Accessories: White nickel



Item **SN03** ▶  
 6 lights chandelier  
 Finish: M04  
 Lampshades: T23 cat.C  
 Accessories: Gold & natural brass  
 Chain 2

Item **Sinuosa EX15**  
 L. 62 x D. 23 cm  
 H. 63 cm

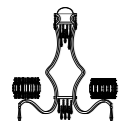

Item **Sinuosa EX16**  
 L. 62 x D. 23 cm  
 H. 63 cm



Item **SN05**  
 Ø 43 cm  
 H. 78 cm



Item **SN04**  
 Ø 63 cm  
 H. 100 cm min

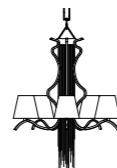

Item **SN03**  
 Ø 75 cm  
 H. 115 cm min



Look at page 204 for finishes.

# Ricerca

year: 2009

Romantic and passionate accents



▲  
◀ Item **Ricerca EX02**  
18 lights chandelier  
Finish: Gunmetal & gold plated details  
Lampshades: Dove grey organza  
Accessories: Gold - Chain 4

# collection

Item **Ricercata EX02, RC01**  
 Ø 120 cm  
 H. 90 cm min

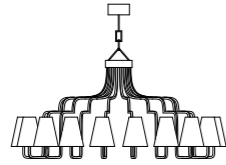

Item **Ricercata EX01**  
 Ø 130 cm  
 H. 75 cm

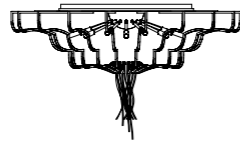

Item **RC02**  
 Ø 86 cm  
 H. 75 cm

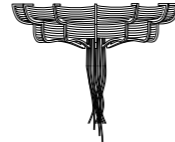

◀ Item **Ricercata EX01**  
 16 lights ceiling lamp  
 Finish: M19  
 Accessories:  
 Gold & natural brass



Item **RC03**  
 L.75 x D.37 cm  
 H. 38 cm

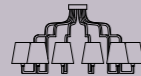

Item **RC04**  
 L.41 x D.13 cm  
 H. 40 cm



Item **RC05**  
 L.32 x D.15 cm  
 H. 64 cm



▲ Item **RC05**  
 1 light wall lamp  
 Finish: M16  
 Lampshade: T07 Cat.B  
 Accessories: White nickel

Item **RC06**  
 Ø 50 cm  
 H. 89 cm



Item **RC07**  
 Ø 50 cm  
 H. 89 cm

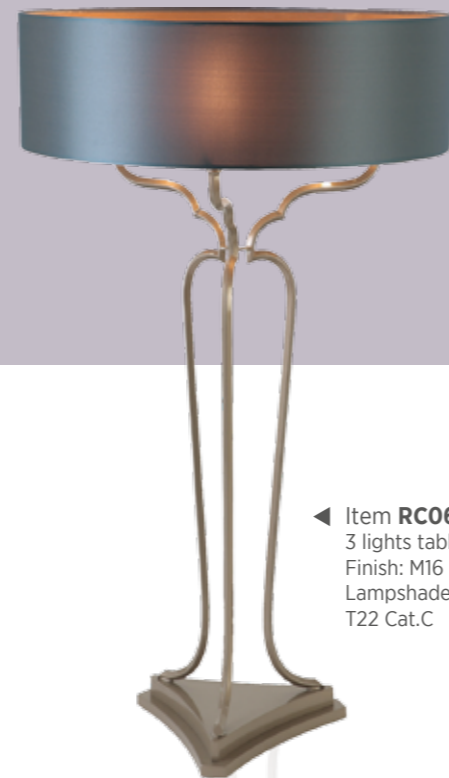

◀ Item **RC06**  
 3 lights table lamp  
 Finish: M16  
 Lampshade:  
 T22 Cat.C

Item **RC08**  
 Ø 55 cm  
 H. 167 cm



Item **RC09**  
 Ø 55 cm  
 H. 167 cm



◀ Item **RC08**  
 6 lights floor lamp  
 Finish: M12  
 Lampshade: T19 Cat.C



▲ Item **RC04**  
 2 lights wall lamp  
 Finish: M17  
 Lampshades: T02 Cat.A

## Impeccable passions

The combination between austere metallic details and precious fabrics suggests an apparently serious atmosphere, whose romantic and passionate accents emerge and turn into the real protagonists.

Look at page 204 for finishes.

# Preziosa

year: 2009

Preziosa owes its expressive power to the light that goes through the precious weave of its lampshades.



◀ Item **PZ04**  
1 light floor lamp  
Finish: M23  
Lampshade: Natural  
brass T31 cat.E



## collection

Item **VL**  
L.41 x D.16 cm  
H.21 cm



Item **PZ02**  
Ø 35 cm  
H.82 cm min



Item **PZ01**  
Ø 52 cm  
H.100 cm min



Item **PZ04**  
Ø 52 cm  
H.210 cm



Look at page 204 for finishes.

Item **PZ01** ▶  
4 lights suspension lamp  
Finish: Black nickel  
Lampshade: Black nickel  
T29 cat.E  
Accessories:  
Black nickel - Chain 3



Item **PZ02**  
1 light suspension lamp

Item **PZ01**  
4 lights suspension lamp  
Finish: Gold  
Lampshade: T12 cat.C  
Accessories: Gold - Chain 3

## Easy *luxury*

Not everyone is able to draw attention without being flashy. To struck a room full of people with a simple and yet magnetic beauty. Preziosa owes its expressive power to the light that goes through the precious weave of its lampshades.



Item **PZ04** ▶  
1 light floor lamp  
Finish: M22  
Lampshade: Black nickel T29 cat.E

Item **PZ04**  
1 light floor lamp  
Finish: M04  
Lampshade:  
T12 cat.C

# Vanitosa

year: 2009

Haughty and exuberant, like a charleston dancer: this is Vanitosa



# Charleston vibes

Haughty and exuberant, like a charleston dancer: this is Vanitosa, dressed in shining fringes that move along the body movements. A peculiarity of this collection is its great range of available finishes and fabrics.



## collection

Item VN01  
Ø 153 cm  
H.165 cm min

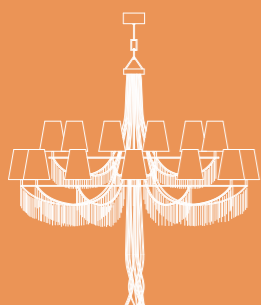

Item VN02  
L.72 X D.43 cm  
H.120 cm



Look at page 204 for finishes.



Item VN01 ▶  
24 lights chandelier  
Finish: M06  
Lampshades: T16 cat.C  
Accessories: Black nickel - Chain 3

◀ Item VN01  
24 lights chandelier  
Finish: M16  
Lampshades: T24 cat.C  
Accessories: Gold - Chain 3

Item VN02 ▶  
5 lights wall lamp  
Finish: M21  
Lampshades: T02 cat.A  
Accessories: Gold



# Eccentrica

year: 2009

One, ten, one hundred levels.  
There isn't an hypothetical limit, nor end, to the modular capacities of Eccentrica.

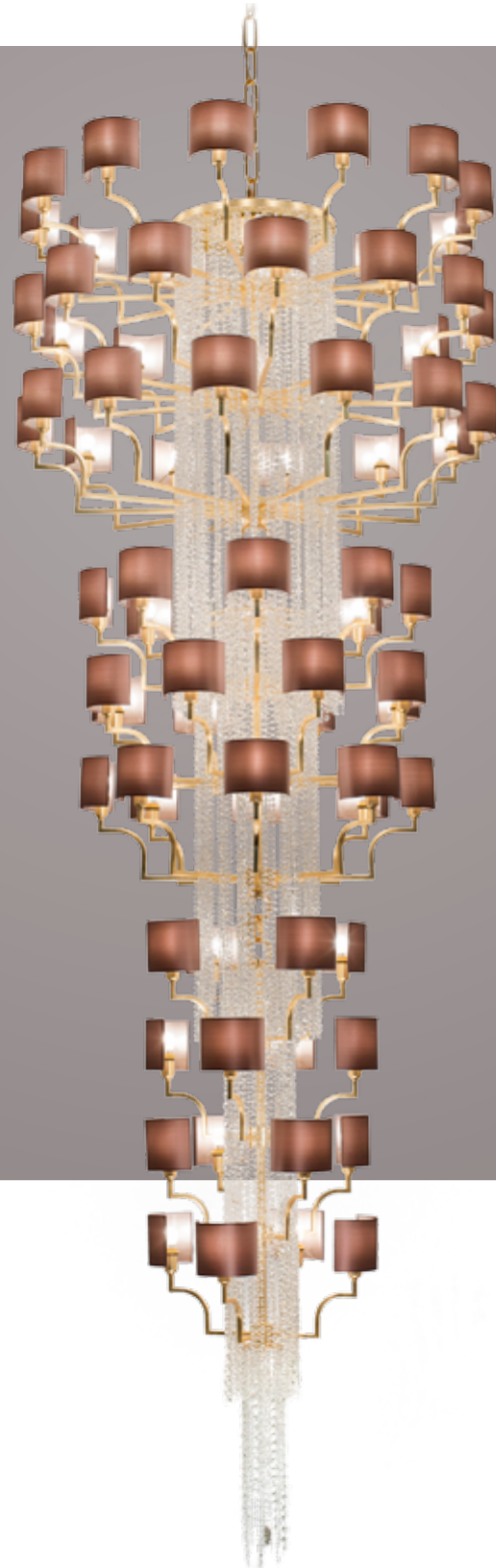

▲ Item **EC12** - 12 lights floor lamp  
Finish: M18  
Lampshades: T12 cat.C  
Accessories: Black nickel

◀ Item **Eccentrica EX03** - 76 lights modular chandelier  
Finish: Gold leaf  
Lampshades: T20 cat.C  
Accessories: Clear crystals

Item **EC11** - 8 lights table lamp ▶  
Finish: M20  
Lampshades: T12 cat.C  
Accessories: Gold & natural brass

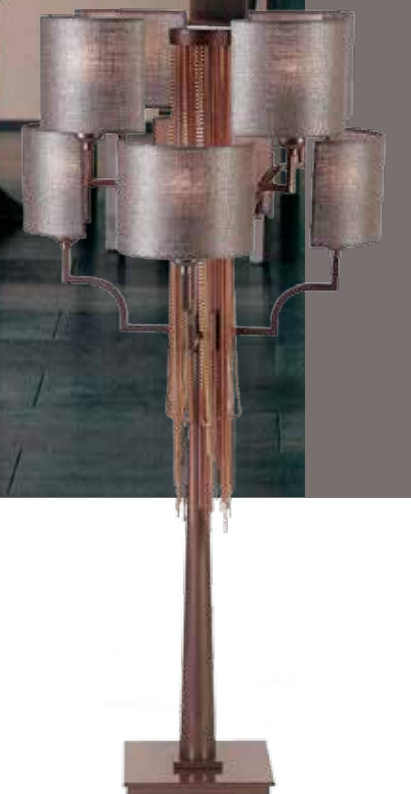





## collection

Item **EC10**  
L.60 x D.32 cm  
H.161 cm

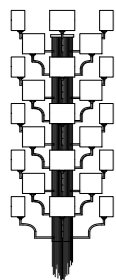

Item **EC07**  
L.60 x D.32 cm  
H.86 cm

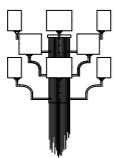

Item **VL**  
L.41 x D.16 cm  
H.21 cm

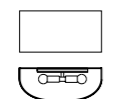

Item **EC08**  
L.60 x D.32 cm  
H.106 cm

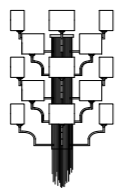

Item **EC11**  
Ø 43 cm  
H.86 cm

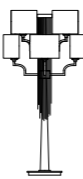

Item **EC12**  
Ø 58 cm  
H.190 cm



Item **Eccentrica EX02 / EX03**  
Ø 120 cm  
H.410 cm

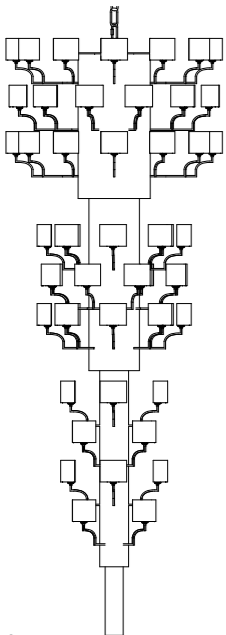

Item **Eccentrica EX01**  
Ø 80 cm  
H.360 cm

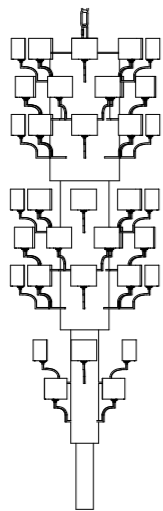

Item **1 EC01 + 4 EC02**  
Ø 60 cm  
H.162 cm min

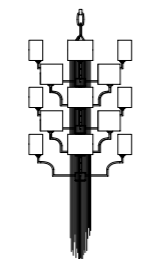

Item **1 EC05 + 4 EC06**  
Ø 100 cm  
H.162 cm min

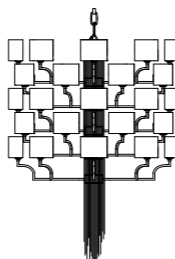

Item **EC13**  
L.120 x D.58 cm  
H.213 cm

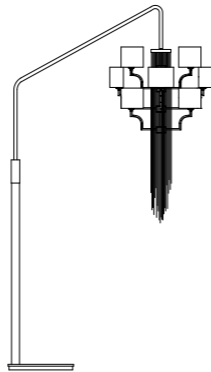

Item **1 EC03 + 4 EC04**  
Ø 80 cm  
H.162 cm min

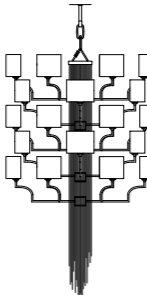

Item **EC09**  
L.60 x D.32 cm  
H.133 cm

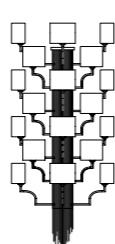

## Never-ending cascade

One, ten, one hundred levels. There isn't an hypothetical limit, nor end, to the modular capacities of Eccentrica. Its main feature and strength is the completely assemblable nature of its modules, arrangeable until the desired height. Versatile in its uses, finishes and chromatic variations, Eccentrica distinguishes itself for another element: a cascade of crystals or chains that runs through it internally.

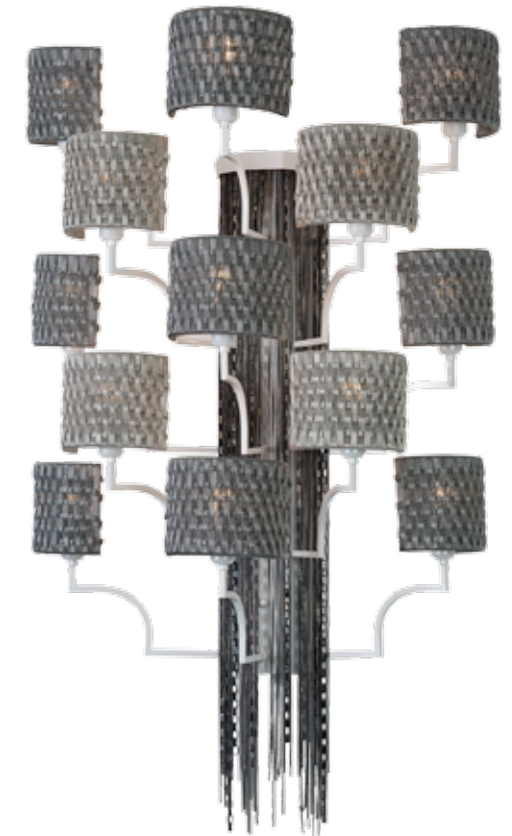

▲ Item **EC08**  
13 lights wall lamp  
Finish: M23  
Lampshades: Black nickel metallic knits T26 cat.D  
Accessories: Black nickel

# Estrosa

YEAR: 2009

A design that becomes decoration, ornamental motive,  
eclectic composition

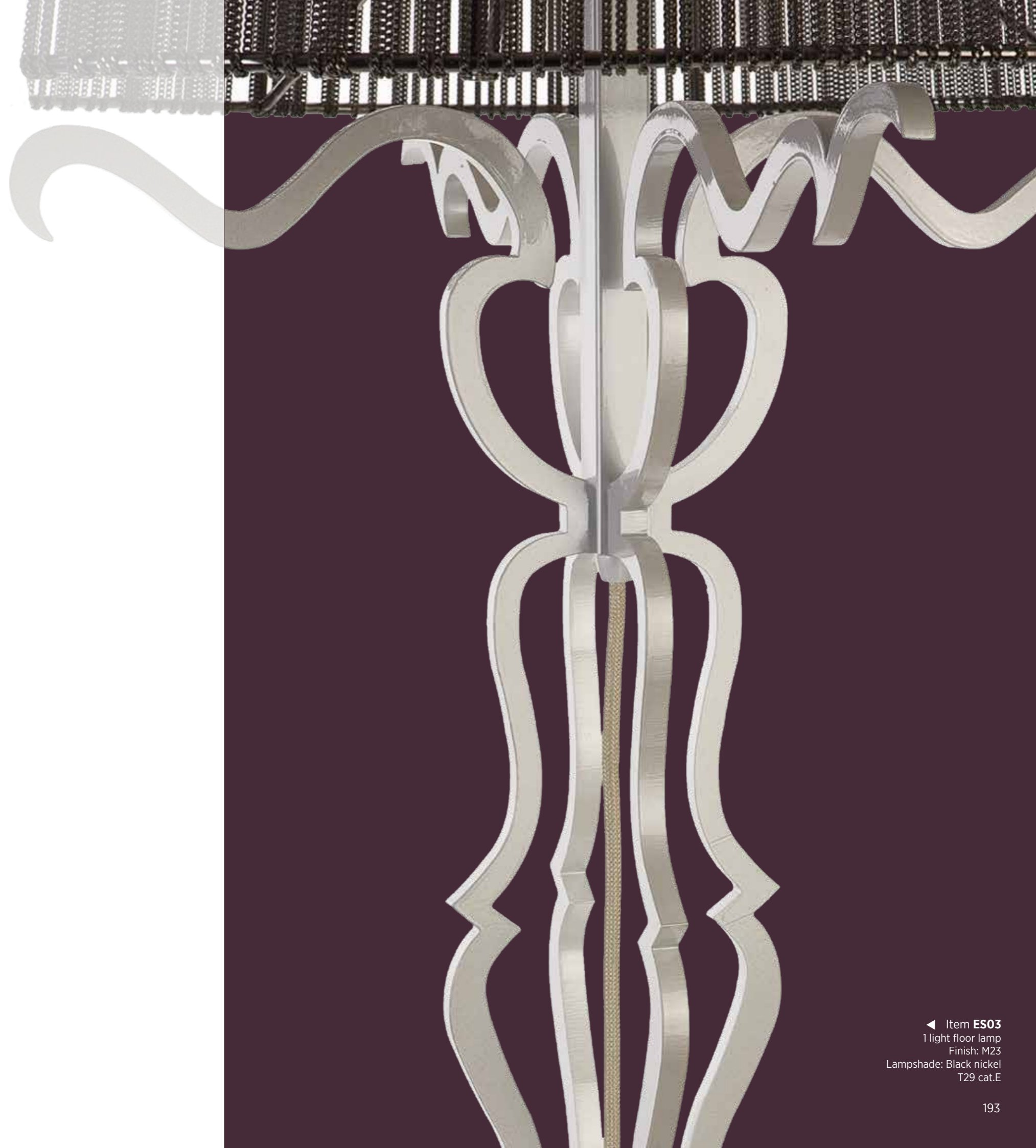
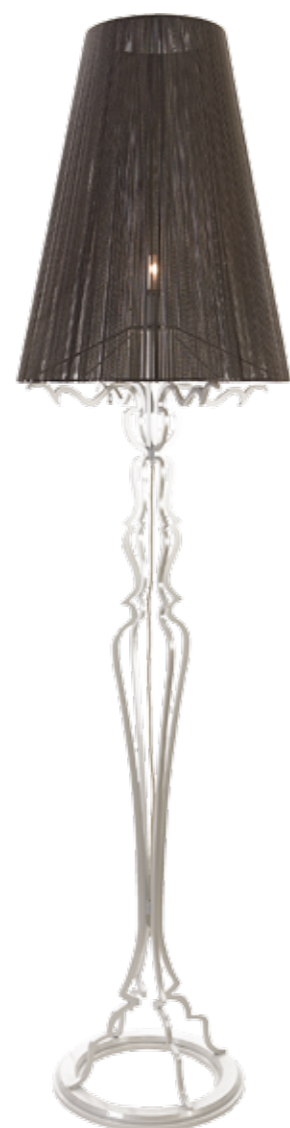

◀ Item **ES03**  
1 light floor lamp  
Finish: M23  
Lampshade: Black nickel  
T29 cat.E



▲ Item **ES02**  
1 light wall lamp  
Finish: M08  
Lampshade: T21 cat.C  
Accessories: White nickel

## Arabesque

A design that becomes decoration, ornamental motive, eclectic composition. In this family every version possesses its peculiarity, its language, while staying true to the general design line.

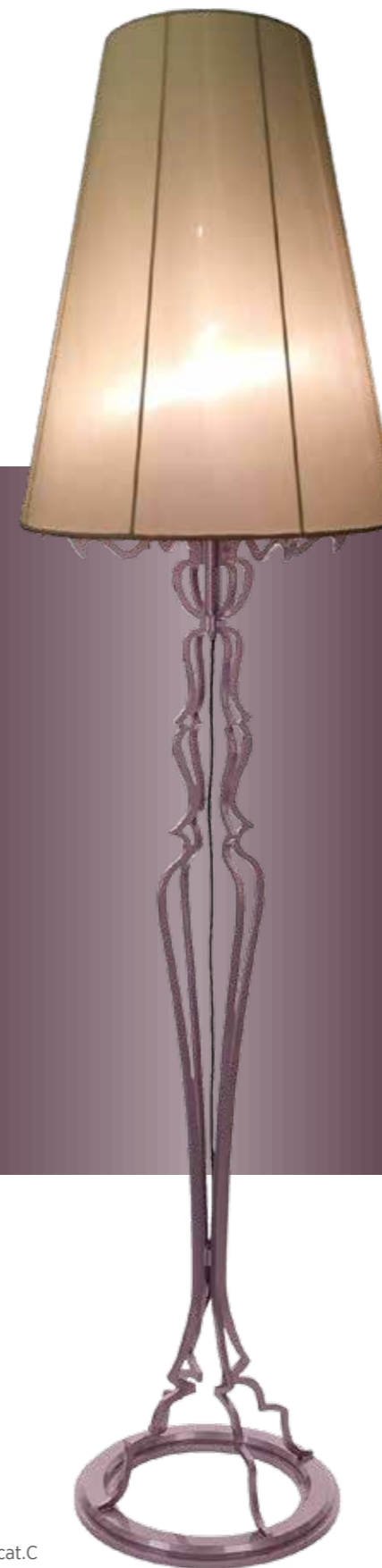

Item **ES03** ▶  
1 light floor lamp  
Finish: M14  
Lampshade: T24 cat.C



Item **ES02** ▶  
1 light wall lamp  
Finish: M21  
Lampshade: T20 cat.C  
Accessories: Black nickel

## collection

Item **ES02**  
L. 43 x D.15 cm  
H. 64 cm



Item **ES03**  
Ø 52 cm  
H. 210 cm

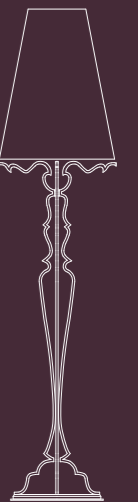

Look at page 204 for finishes.

# Raffinata

year: 2009

High level to customization.

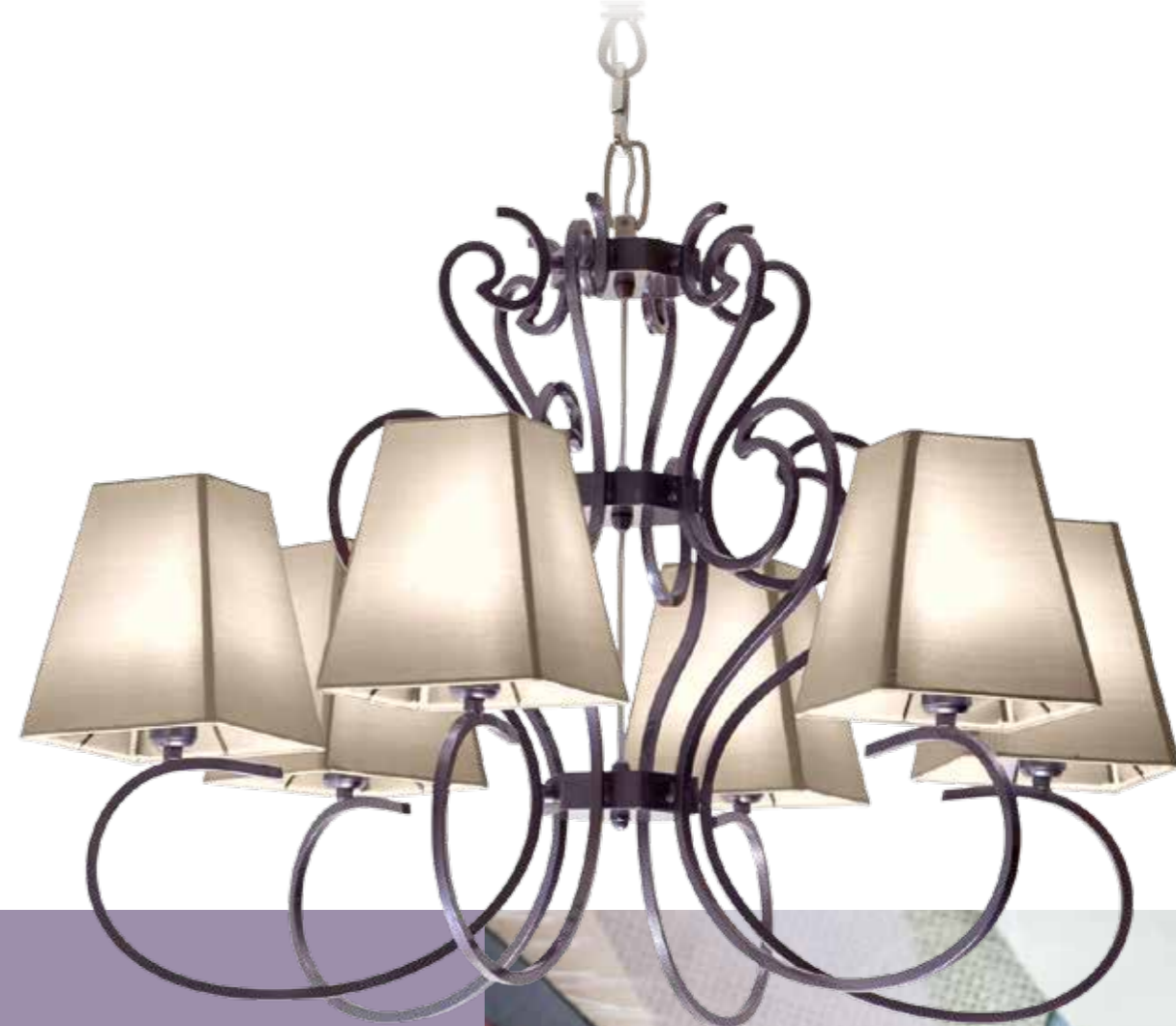

The *name*  
is a destiny

Raffinata in name and in essence. Due to its formal simplicity, to the roundness of its curves, to its timeless elegance.

In this collection the protagonist is still the high level of possible customization, obtained through a great array of metallic finishes and fabrics available.

▲ Item **RA02**  
6 lights chandelier  
Finish: M15  
Lampshades: T24 cat.C  
Chain 2

◀ Item **RA02** custom  
6 lights chandelier  
Finish: Satin brass  
Lampshades: Gold T30 cat.E  
Chain 2



## collection

Item **RA03**  
L.53 x D.15 cm  
H.94 cm

Item **RA02**  
Ø 75 cm  
H.85 cm min

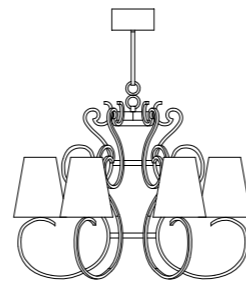

Item **RA03** ▲  
2 lights wall lamp  
Finish: M02  
Lampshades: White nickel T28 cat.E  
Accessories: White nickel

▲ Item **RA03**  
2 lights wall lamp  
Finish: M02  
Lampshades: T16 cat.C  
Accessories: Black nickel

Look at page 204 for finishes.

# Stravagante

year: 2009

Strong and delicate at the same time.



◀ Item **Stravagante EX05**  
9 lights chandelier  
Finish: Chrome  
Lampshade: T17 cat.C  
Accessories: White nickel - Chain 3

▲ Item **ST02**  
18 lights chandelier  
Finish: M18  
Lampshade: T07 cat.B  
Accessories: Gold - Chain 3

Item **ST01** ▶  
 27 lights chandelier  
 Finish: M05  
 Lampshades: T20 cat.C  
 Accessories:  
 White nickel - Chain 3



▲ Item **ST07**  
 5 lights wall lamp

In the mood  
 for **love**

In this collection there is something that reminds of the Far East, its grace, its elegance. Maybe, it could be the big circular lampshades, created in precious fabrics or the bending, ornamental chains, or maybe the pending, charming gems. Strong and delicate at the same time.

Item **ST04** ▶  
 9 lights wall lamp  
 Finish: M05  
 Lampshade: T20 cat.C  
 Accessories: White and black nickel



# collection

Item **Stravagante EX03**  
 Ø 160 cm  
 H. 170 cm min

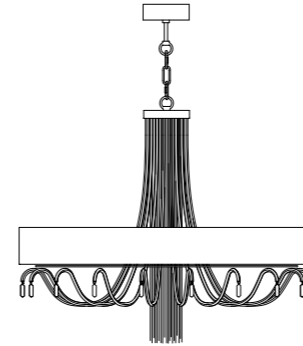

Item **Stravagante EX05, ST03**  
 Ø 78 cm  
 H.170 cm min

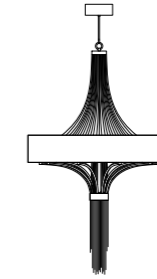

Item **Stravagante EX02**  
 Ø 200 cm  
 H.210 cm min

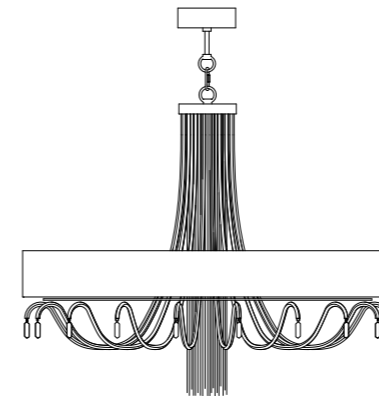

Item **ST01**  
 Ø 122 cm  
 H. 228 cm min

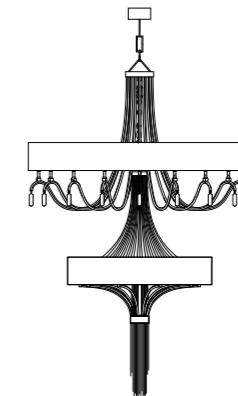

Item **Stravagante EX01**  
 Ø 200 cm  
 H. 380 cm min

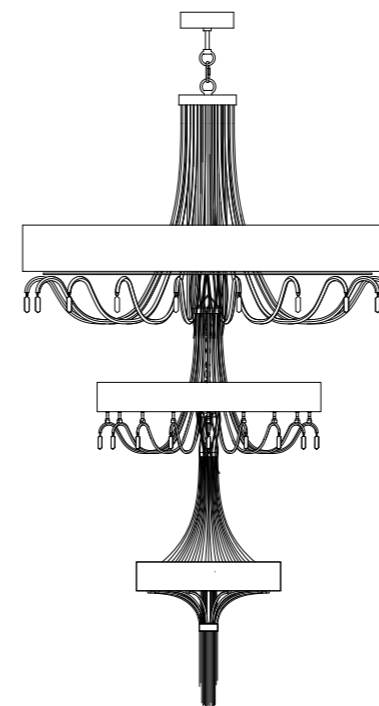

Item **ST05**  
 L.91 x D.47 cm  
 H. 59 cm

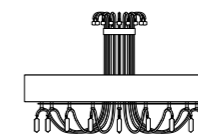

Item **ST04**  
 L.91 x D.47 cm  
 H. 79 cm

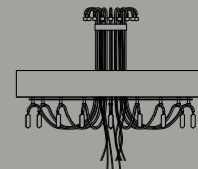

Item **ST06**  
 L.51 x D.26 cm  
 H. 72 cm

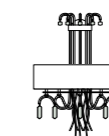

Item **ST02**  
 Ø 122 cm  
 H. 112 cm min

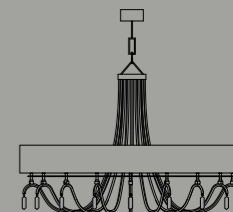

Item **ST07**  
 L.51 x D.26 cm  
 H. 52 cm

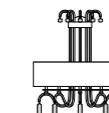

Look at page 204 for finishes.

# finishes

available for Eccentrica, Estrosa, Preziosa, Raffinata, Ricercata, Sinuosa, Stravagante, Vanitosa

## metal finishes



# finishes

available for Eccentrica, Estrosa, Preziosa, Raffinata, Ricercata, Sinuosa, Stravagante, Vanitosa

## Lampshade fabrics



## metallic\*

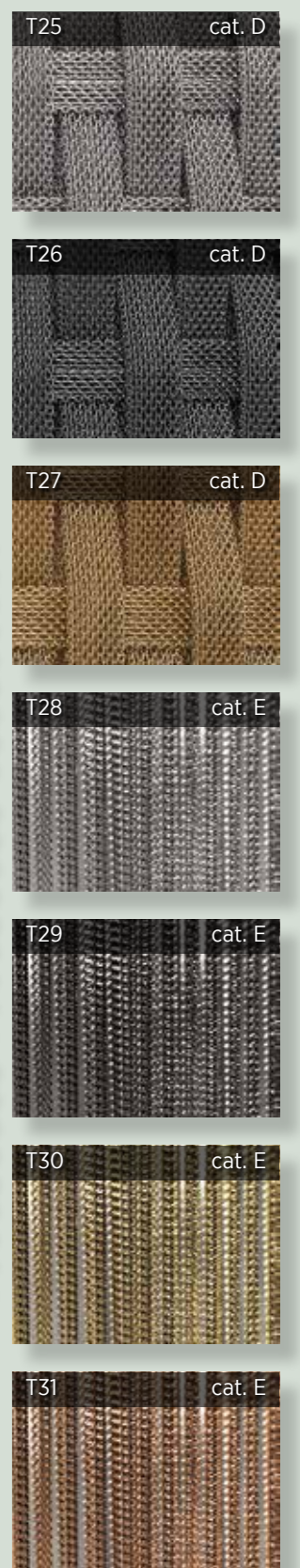

available only for:  
Eccentrica, Preziosa,  
Estrosa



designer PATRIZIA GARGANTI

# Home

year: 2011



▲ Item **PG1008**  
Leather tape weave armchair  
White leather string with  
aubergine fabric  
cat. A/06



◀ Item **PG1002**  
Armchair  
Slate grey velvet  
cat. C/03



◀ Item **PG1008 custom**  
Leather tape weave  
armchair  
Black leather string with  
custom velvet



◀ Item **PG1002**  
Armchair  
Ivory with ivory piping  
leather  
cat. E/04

▼ Item **PG1002**  
Armchair  
Customized leather  
cat. E





◀ Item **PG1003**  
Customized leather sofa  
cat. E



Item **PG1003** ▶  
Sofa  
Dark grey velvet  
cat. C/02



▲ Item **PG1010**  
Leather tape weave sofa  
White leather string with  
aubergine fabric  
cat. A/06



Item **PG1003** ▶  
Sofa  
Taupe velvet  
cat. C/01



Item **PG1000** ▶  
Ivory with caramel  
piping leather  
cat. E/01



Item **PG1000** ▶  
Brown with caramel  
piping leather  
cat. E/02



“Un uomo,  
se possiede la vera sapienza,  
sa godere dell'intero spettacolo del  
mondo da una sedia,  
senza saper leggere,  
senza parlare,  
con nessuno,  
solo con l'uso dei sensi  
e con l'anima che non sappia essere  
triste.”

Fernando Pessoa



Item **PG1000** ▶  
Black with caramel  
piping leather  
cat. E/03



Item **PG1006** ▶  
Golden brown leather  
string with caramel  
fabric





Item **PG1000** ▶  
Red with matching piping fabric  
cat. A/01

◀ Item **PG1000**  
Melange light blue with matching piping fabric  
cat. A/02

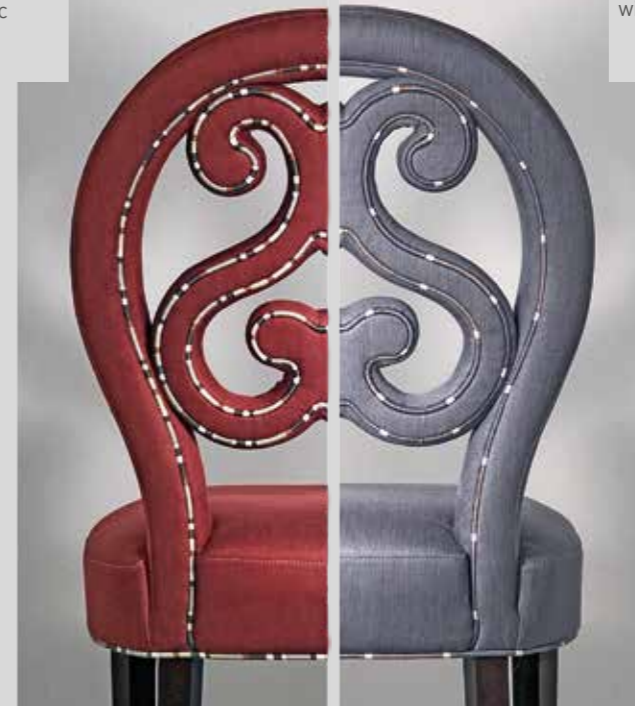

Item **PG1000** ▶  
Sage with matching piping fabric  
cat. A/03

◀ Item **PG1000**  
Brown grey with matching piping fabric  
cat. A/04

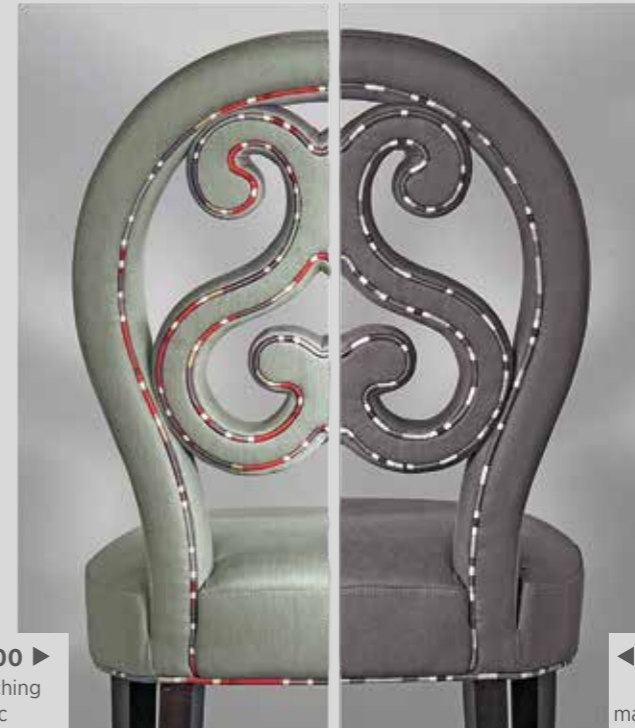

## CAT. A

61% linen - 39% cotton



**01** - Red with matching piping fabric



**02** - Melange light blue with matching piping fabric



**03** - Sage with matching piping fabric



**04** - Brown grey with matching piping fabric



**05** - Beige fabric



**06** - Aubergine fabric



**07** - Camel fabric



**08** - Light sea green fabric

## CAT. B

100% cotton



**B** - Brown velvet

## CAT. C

100% cotton



**01** - Taupe velvet



**02** - Dark grey velvet



**03** - Slate grey velvet



**04** - Ecru velvet

## CAT. D

50% cotton - 50% iuta



**D** - Grey fabric

## CAT. E

100% leather



**01** - Ivory with caramel piping leather



**02** - Brown with caramel piping leather



**03** - Black with caramel piping leather



**04** - Ivory with ivory piping leather



**05** - Brown with brown piping leather

## TAPE

100% leather



White leather string



Clay leather string



Golden brown leather string



Chocolate brown leather string



Black leather string

Item **PG1000**  
L.52 x D.52 cm  
H.102 cm



Item **PG1002**  
L.67 x D.67 cm  
H.104 cm



Item **PG1003**  
L.180 x D.68 cm  
H.104 cm

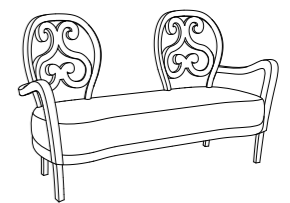

Item **PG1006**  
L.52 x D.52 cm  
H.102 cm



Item **PG1008**  
L.67 x D.67 cm  
H.104 cm



Item **PG1010**  
L.180 x D.68 cm  
H.104 cm

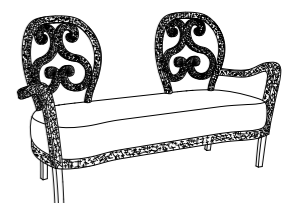



▲ Item **D12**  
Coffee table  
Finish: Polished nickel  
Accessories: Black leather tape  
Table top: Smoky glass



▲ Item **D13**  
Coffee table  
Finish: Polished nickel  
Accessories: Brown leather tape  
Table top: Bronze glass

▼ Item **D15**  
Coffee table  
Finish: Polished nickel  
Accessories: Brown leather tape  
Table top: Bronze glass



▼ Item **D14**  
Coffee table  
Finish: Polished nickel  
Accessories: Black leather tape  
Table top: Smoky glass



▲ Item **D11 & D12**  
Coffee tables  
Finish: Satin gold  
Accessories: White leather tape  
Table top: Bronze glass

# Collection

Item **D11**  
L.100 x D.30 cm  
H.48 cm



Item **D12**  
L.118 x D.49 cm  
H.44 cm

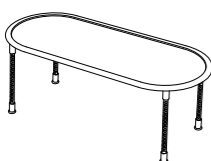

Item **D13**  
L.80 x D.49 cm  
H.44 cm



Item **D14**  
Ø 60 cm  
H.62 cm



Item **D15**  
Ø 42 cm  
H.52 cm



Item **PG1020**  
Ø 54 cm  
H.78 cm



Item **PG1021**  
Ø 40 cm  
H.71 cm



## metal finishes



gunmetal



burnished brass

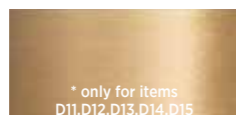

\* only for items  
D11, D12, D13, D14, D15

satin gold

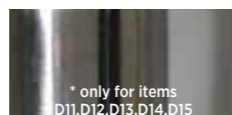

\* only for items  
D11, D12, D13, D14, D15

polished nickel

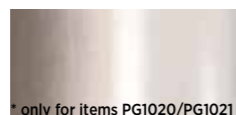

\* only for items PG1020/PG1021

satin nickel



\* only for items PG1020/PG1021

satin brass

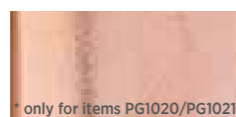

\* only for items PG1020/PG1021

copper

## accessories



white leather  
tape



peach leather  
tape



lime leather  
tape



brown leather  
tape



elephant leather  
tape



black leather  
tape

## table top



clear glass



smoky glass



bronze glass

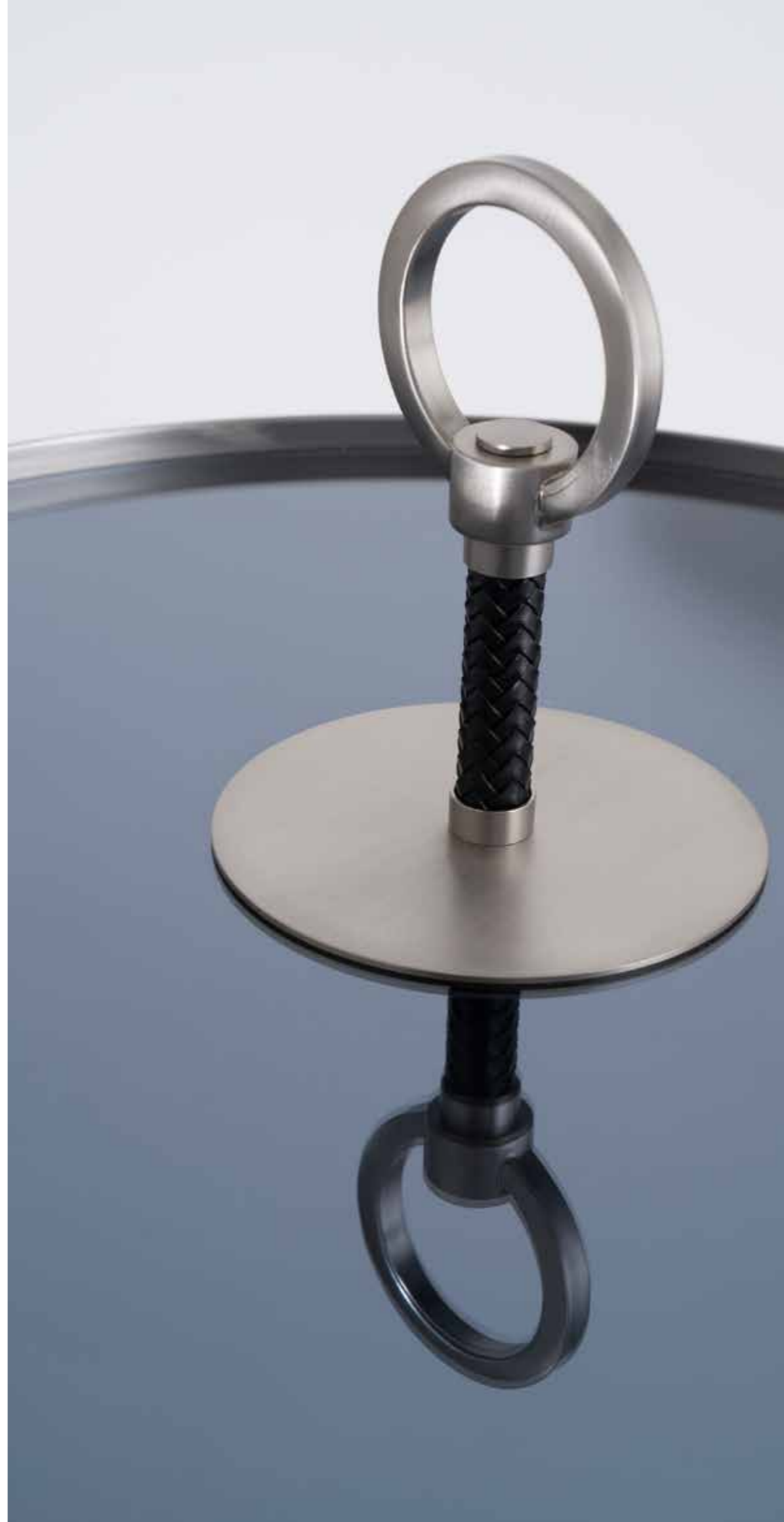

▲ Item **PG1020 & PG1021**  
Tea tables  
Finish: Satin nickel  
Accessories: Black leather tape  
Table top: Smoky glass

Ringraziamo per la  
collaborazione architetti,  
interior designer, cantieri  
navali e aziende leader  
nell'arredamento che ci  
hanno fornito le immagini  
dei vari progetti realizzati  
nel mondo con i nostri  
prodotti.

Un grazie va a tutti i nostri  
collaboratori, artigiani  
e professionisti, che  
con grande dedizione e  
passione permettono alla  
nostra azienda di realizzare  
prodotti di eccellenza.

We wish to thank architects,  
interior designers, shipyards  
and leading furniture  
companies for their  
collaboration, who provided  
us with images of the  
projects carried out in the  
world with our products.  
A special thank goes to all  
our collaborators, artisans  
and professionals who  
with great dedication and  
passion allow our company  
to create  
products of excellence.

Patrizia Garganti s.r.l.  
Via Lucchese 39  
50019 Sesto Fiorentino  
Firenze - Italy  
ph. +39 055 310607  
patrizia@patriziagarganti.it  
www.patriziagarganti.com





